

TELEVISION

RADIO'S GREATEST MAGAZINE

RADIOVISION

NOVEMBER  
25 Cents

Over 200  
Illustrations



# RADIO NEWS

REG. U.S. PAT. OFF.

Edited by HUGO GERNSBACK

## TELEVISION NUMBER

HOW TO BUILD YOUR OWN TELEVISION RECEIVER

SEE PAGE 422

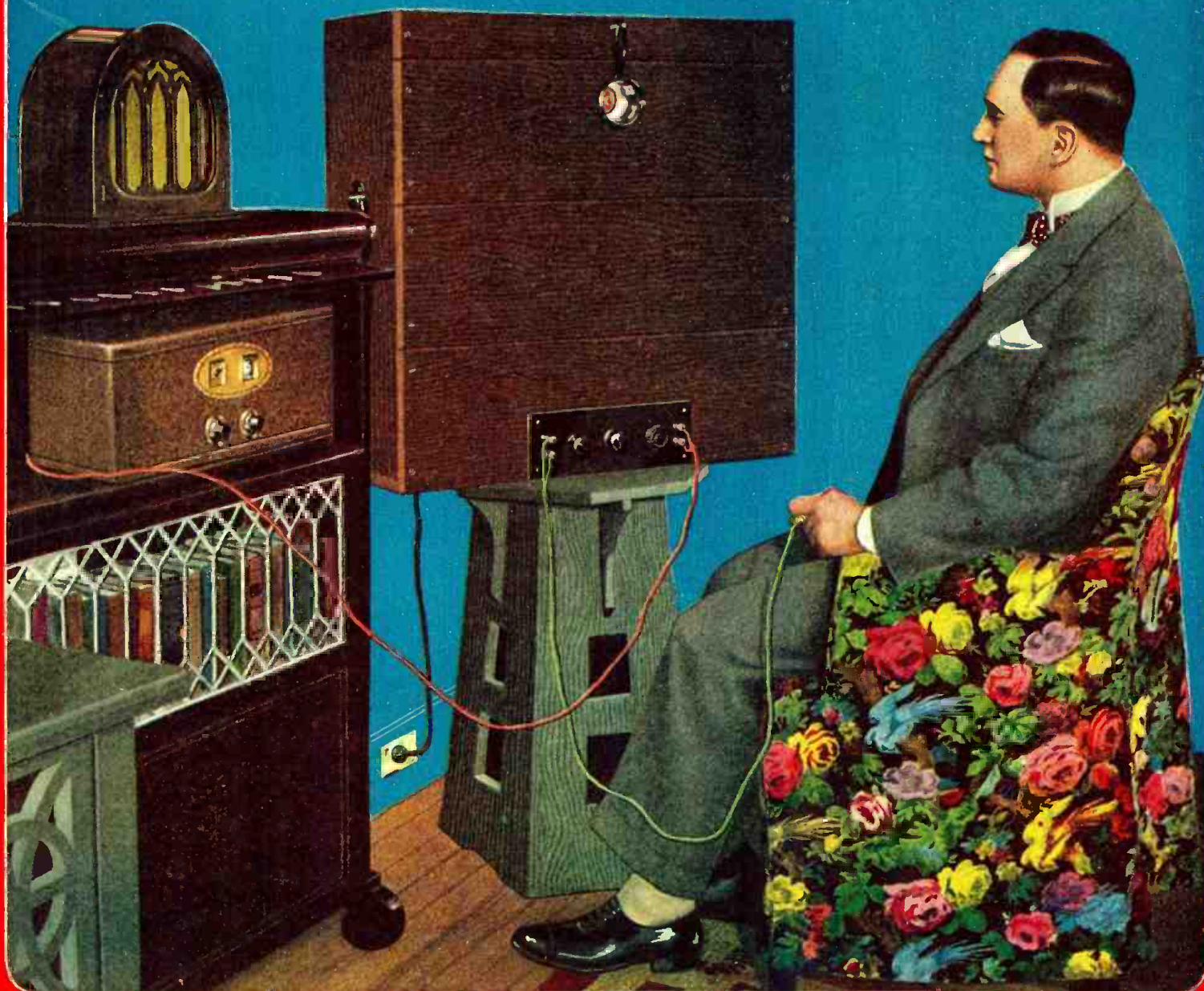

ELEVISION

EXPERIMENTER PUBLISHING COMPANY, 230 FIFTH AVENUE, NEW YORK

RADIOVISION

# A NEW NOTE IN AUDIO AMPLIFICATION

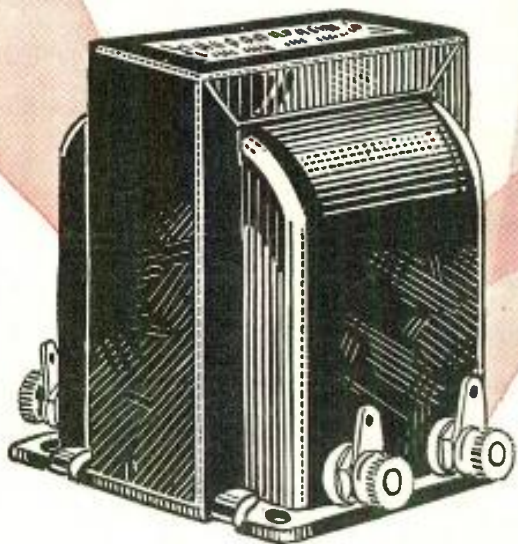

## THORDARSON R-300 AUDIO TRANSFORMER

**S**UPREME in musical performance, the new Thordarson R-300 Audio Transformer brings a greater realism to radio reproduction. Introducing a new core material, "DX-Metal" (a product of the Thordarson Laboratory), the amplification range has been extended still further into the lower register, so that even the deepest tones now may be reproduced with amazing fidelity.

The amplification curve of this transformer is practically a straight line from 30 cycles to 8,000 cycles. A high frequency cut-off is provided at 8,000 cycles to confine the amplification to useful frequencies only, and to eliminate undesirable scratch that may reach the audio transformer.

When you hear the R-300 you will appreciate the popularity of Thordarson transformers among the leading receiving set manufacturers. The R-300 retails for \$8.00.

**THORDARSON ELECTRIC MANUFACTURING CO.**  
*Transformer Specialists Since 1895*  
**WORLD'S OLDEST AND LARGEST EXCLUSIVE TRANSFORMER MAKERS**  
*Huron and Kingsbury Streets — Chicago, Ill. U.S.A.*

### Power Supply Transformers

These transformers supply full wave rectifiers using two UX-281 tubes, for power amplifiers using either 210 or 250 types power amplifying tubes as follows: T-2098 for two 210 power tubes, \$20.00; T-2900 for single 250 power tube, \$20.00; T-2950 for two 250 tubes, \$29.50.



### Double Choke Units

Consist of two 30 henry chokes in one case. T-2099 for use with power supply transformer T-2098, \$14; T-3099 for use with transformer T-2900, \$16; T-3100 for use with transformer T-2950, \$18.



### Power Compacts

A very efficient and compact form of power supply unit. Power transformer and filter chokes all in one case. Type R-171 for Raytheon rectifier and 171 type power tube, \$15.00; Type R-210 for UX-281 rectifier and 210 power tube, \$20.00; Type R-280 for UX-280 rectifier and 171 power tube, \$17.00.



### Speaker Coupling Transformers

A complete line of transformers to couple either single or push-pull 171, 210 or 250 power tubes into either high impedance or dynamic speakers. Prices from \$6.00 to \$12.00.



### Screen Grid Audio Coupler

The Thordarson Z-Coupler T-2909 is a special impedance unit designed to couple a screen grid tube in the audio amplifier into a power tube. Produces excellent base note reproduction and amplification vastly in excess of ordinary systems. Price, \$12.00.



**THORDARSON ELECTRIC MFG. CO.**  
500 W. Huron St., Chicago, Ill. 3583-L

Gentlemen: Please send me your constructional booklets on your power amplifiers. I am especially interested in amplifiers using.....tubes.

Name.....

Street and No.....

Town..... State.....

# EARNED \$500 SPARE TIME WITH RADIO

Coplay, Pa., June 4—(RA)—During the few months that Frank J. Deutsch has been a member of the Radio Association of America, he has made over \$500 out of Radio in his spare time.

"Four super-heterodyne sets of my own construction brought me a profit of \$60.00 each, and the other profit was from sales of supplies purchased through the Wholesale Department of the Association," he said. "The Association certainly has a great plan for ambitious men."

In a neighboring state, Werner Eichler, Rochester, N. Y., another member of the Association, has been making \$50 a week during his spare time.

They are only two of the hundreds of Radio Association members who are making money out of Radio in their spare time.

## BECOMES RADIO ENGINEER IN ONE YEAR

Toronto, Canada, May 20—(RA)—One of the newly admitted associate members of the Institute of Radio Engineers is Claude DeGrave, a member of the engineering staff of the DeForest Company of this city. "I knew nothing about Radio and started from the ground up," Mr. DeGrave stated, "when I enrolled a year ago in the Radio Association. Its easy lessons and superb training made it possible for me to become a Radio Expert in less than a year's time. My income is now about 225% more than at the time I joined the Association."

The Institute of Radio Engineers is a very exclusive organization, and its membership requirements are very rigid, so that Mr. DeGrave has reason to be proud of his election.

## Clerk Doubles Income In Six Months Through Radio

Chicago, Ill., May 9—Even though his membership in the Radio Association has resulted in W. E. Thon securing the management of a Radio Department in a large Chicago store, his ambition was not satisfied. Six months later, he started his own store.

"The Radio Association has an excellent plan for the man who wants to get out of the rut and succeed," says this man who quickly rose from clerkdom to the proprietorship of a profitable radio store. "I attribute my success entirely to the Radio Association of America. Six months after I had enrolled, I had doubled my income through its help."

# 5 Easy Ways to make \$3<sup>00</sup> an hour in Your Spare Time in RADIO

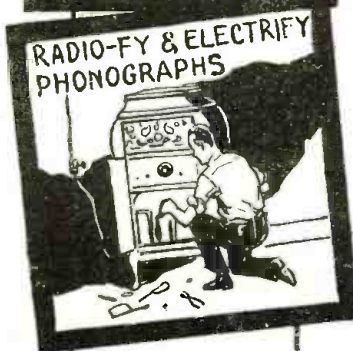
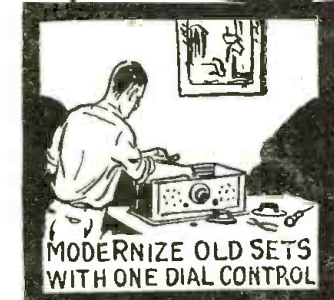
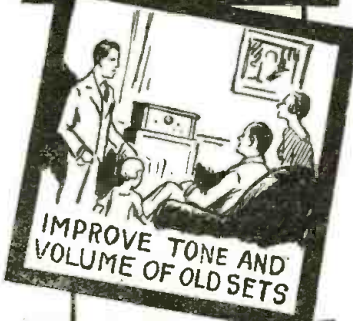

EACH of these plans, developed by the Radio Association of America, is a big money-maker. Set owners everywhere want to get rid of static, to have their sets operate from the electric light socket, the tone improved, and the volume increased, and transformed into single-dial controls. Phonograph owners want their machines electrified and radiofied. If you learn to render these services, you can easily make \$3.00 an hour for your spare time, to say nothing of the money you can make installing, servicing, repairing, and building radio sets, and selling supplies.

Over \$600,000,000 is being spent yearly for sets, supplies, service. You can get your share of this business and, at the same time, fit yourself for the big-pay opportunities in Radio by joining the Association.

## Join the Radio Association of America

A membership in the Association offers you the easiest way into Radio. It will enable you to earn \$3.00 an hour upwards in your spare time—train you to install, repair, and build all kinds of sets—start you in business without capital or finance an invention—train you for the \$3,000 to \$10,000 big-pay radio positions—help secure a better position at bigger pay for you. *A membership need not cost you a cent!*

The Association will give you a comprehensive, practical, and theoretical training and the benefit of our Employment Service. You earn while you learn. Our cooperative plan will make it possible for you to establish a radio store. You have the privilege of buying radio supplies at wholesale from the very first.

## ACT NOW—If you wish No-Cost Membership Plan

To a limited number of ambitious men, we will give Special Memberships that may not—need not—cost you a cent. To secure one, write today. We will send you details and also our book, "Your Opportunity in the Radio Industry." It will open your eyes to the money-making possibilities of Radio.

### COUPON

RADIO ASSOCIATION OF AMERICA  
Dept. RN-11, 4513 Ravenswood Ave.,  
Chicago, Ill.

Gentlemen:  
Please send me by return mail full details of your Special Membership Plan, and also copy of your book, "Your Opportunity in the Radio Industry."

Name.....

Address.....

City..... State.....

# RADIO NEWS

Volume 10

NOVEMBER, 1928

Number 5

HUGO GERNSBACK, Editor-in-Chief

ROBERT HERTZBERG, Managing Editor

C. P. MASON, Associate Editor

BERYL B. BRYANT, Laboratory Director

C. WALTER PALMER, Director Information Service

## Contents of This Issue

Future Progress in Television By Hugo Gernsback	411	* "Rays of Justice" By C. Sterling Gleason	432
Successful Television Programs Broadcast by Radio News Station WRNY By Robert Hertzberg	412	What's New in Radio	434
"Radio Movies" from KDKA	416	Putting the Aerial in Shape for Winter By L. B. Robbins	437
How "Stereoscopic" Television is Shown By R. F. Tiltman	418	Electrodynamic Speakers Become Popular By Fred H. Canfield	438
Televentures, Telewitticisms and the Televocabulary	419	The Radio Beginner—Some Facts About Transformers By C. Walter Palmer	442
The Jenkins "Radio-Movie" Reception Methods	420	Broadcastatics	445
Successful DX Work Marks "Radio- Movie" Transmissions	421	How to Construct the "Pre-Selector" By S. Gordon Taylor	446
Synchronized Broadcast Joins Images and Music	426	Magneto-Striction By M. J. Cuttler	450
The Neon Tube—Television's "Loud Speaker" By D. E. Replogle	427	Ways of Sensitizing the R.F. Amplifier with Stability	453
How to Adjust the Television Receiver for Operation	428	Radio Wrinkles	454
Television Teems with Trials for Telex- perimenters	429	On the Short Waves	456
List of Broadcast Station Calls	430	The Radio Constructor's Own Pages	458
		RADIO NEWS Laboratories	460
		I Want to Know By C. W. Palmer	462
		Radiotics	470
		Radio as an Advertising Force	472
		Radio "Bugs"	474

RADIO NEWS is published on the 10th of each preceding month. There are 12 numbers per year. Subscription price is \$2.50 a year in U. S. and possessions. Canada and foreign countries, \$3.00 per year. U. S. Coin as well as U. S. Stamps accepted (no foreign coins or stamps). Single copies, 25 cents each. Checks and money orders should be drawn to order of EXPERIMENTER PUBLISHING CO., INC.

All communications and contributions to this journal should be addressed to Editor, RADIO NEWS, 230 Fifth Ave., New York, N. Y. Unaccepted contributions cannot be returned unless full postage has been included. All accepted contributions are paid for on publication. A special rate is paid for novel experiments; good photographs accompanying them are highly desirable. Publishers are not responsible for loss of manuscripts, although every precaution is taken with such manuscripts, upon receipt thereof.

RADIO NEWS, Monthly. Entered as second-class matter, July 12, 1924, at the Post Office at New York, N. Y., under the Act of March 3, 1879. Additional entry at Dunellen, N. J. and San Francisco, Calif. Title registered U. S. Patent Office, Copyright, 1928, by The Experimenter Publishing Co., Inc., 230 Fifth Ave., New York. The contents of this magazine are copyrighted and must not be reproduced in the United States without giving full credit to the publication. Translation into foreign languages must not be made unless permission is obtained from the publishers. Copyrighted in Germany. Reproduction of articles in Germany is reserved for Radio, Berlin 42.

The contents of RADIO NEWS are indexed in the Industrial Arts Index, copies of which can be found in every library.

obtained from the publishers. Copyrighted in Germany. Reproduction of articles in Germany is reserved for Radio, Berlin 42.

RADIO NEWS is for sale at all newsstands in the United States and Canada, and at Brentano's, Ave. de L'Opera, Paris, France. European agents: S. J. Wise Et Cie, 40 Place Verte, Antwerp, Belgium.

HOW TO SUBSCRIBE FOR RADIO NEWS. Send your name, address and remittance to Experimenter Publishing Co., 230 Fifth Ave., New York. Mention the name of the magazine you are ordering. We also publish SCIENCE AND INVENTION, RADIO LISTENERS' GUIDE and AMAZING STORIES. Write clearly.

RATES AND TERMS. The subscription rate for RADIO NEWS is \$2.50 per year (12 numbers). When remitting do so by check, money order, or registered letter if cash is enclosed. Avoid sending cash through the mail if possible. Subscriptions for less than one year are not accepted. Subscription may be made in combination with SCIENCE & INVENTION, RADIO LISTENERS' GUIDE, and AMAZING STORIES.

POSTAGE. We prepay postage in all parts of the United States, Mexico and island possessions. For foreign or Canadian subscriptions we require 50 cents in addition to the subscription price for additional postage charge.

CHANGE OF ADDRESS. Notify us as far in advance as possible. It requires several weeks to make an address change on our records. Always write clearly.

Published by **Experimenter Publishing Company, Inc.**

H. GERNSBACK, President

S. GERNSBACK, Vice-President and Treasurer

ALFRED A. COHEN, Secretary

Member: Audit Bureau of Circulations

Radio Magazine Publishers Association

Advertising Representatives: RHODES &amp; LEISENRING

New York Offices: 624 Graybar Building

Chicago Offices: 307 North Michigan Ave.

Editorial and General Offices

230 Fifth Avenue, New York City

**ONLY**  
**\$ 99** for this **PACKARD**  
**SUPER 8—\$250 A. C.**  
**ELECTRIC RADIO SET** !

**Direct From Our Factory**

Today's greatest radio! A truly sensational offer! The Eight-tube PACKARD A. C. Electric Radio — a regular \$250 set — shipped to any home in the U. S. at direct from factory price of only \$99. And to prove our claims we will ship this set to your home on

**\$5000.00**  
**CASH BOND**  
**to Back Our**  
**GUARANTEE**



**The PACKARD Engineers**

have invented this most unusual, powerful SUPER-Eight Tube Radio. Astonishing volume and tone quality. Remarkable selectivity and long-distance reception. Leading radio engineers unanimously agree that there is no better radio made — regardless of price.

Let us prove this by shipping a set to your home on 30 days' trial. Examine the set from A to Z. Let the most exacting critics pass on its merits. And if, after the 30 day trial period, you are convinced that the Packard Eight-tube Electric is fully the equal of any console radio set selling up to \$250—then, and only then, need you decide to keep it at our factory price of only \$99 —otherwise, return it.

This marvelous set combines every new scientific development in receiving sets—possessing beauty, refinement, durability. Gets everything on the air from coast to coast—from Mexico into Canada, loudly, clearly, and distinctly. Only one dial to tune in all stations.

**You Save the Jobbers', Dealers' and Salesmen's Profits**

The PACKARD Radio is shipped direct from our factory. All the in-between profits are deducted from the price of the set and instead of paying \$250 you pay only \$99. Quantity production, economy in selling, and only a small profit for the manufacturer makes this astounding offer possible..

**MAIL COUPON NOW FOR**

**30 days' free trial offer**

Don't miss this opportunity. Mail coupon at once for complete information about the PACKARD A. C.— 8 TUBE ELECTRIC RADIO and our liberal 30 days' free trial offer. No obligation on your part. Our \$5,000.00 cash bond backs up our guarantee.

**PACKARD RADIO CO.**

**2323 Milwaukee Ave. Dept. 321 Chicago, Ill.**



**WORLD'S GREATEST RADIO**  
**Genuine Walnut Console Cabinet**

Eight powerful A. C. tubes and one genuine full-wave rectifying tube—nine tubes in all. Supreme quality throughout. Simple to operate. Connect the plug to electric socket and turn switch. Only one dial to tune. One hundred per cent electric. Handsome walnut cabinet—two-tone genuine DUCO finish. Metal trimming finished in old gold. Marvellous built-in, powerful speaker. Size of cabinet is 54 inches high, 27 inches wide.

**Packard Radios are also**  
**made for BATTERY OPERATION**  
**PRICED AS LOW AS \$53**

**Packard Radio Company**  
 2323 Milwaukee Ave., Dept. 321, Chicago, Ill.

I am interested in Packard Radios and your \$5,000.00 Bonded 30 days' free trial offer and guarantee. Send full details.

Name.....

Address.....

City..... State.....

Please say you saw it in RADIO NEWS

# INDEX TO ADVERTISERS

	Page		Page		Page
<b>A</b>		<b>F</b>		<b>R</b>	
Aero Products, Inc.....	480	Fanspeaker Radio Co.....	482	Pathfinder .....	483
Aerovox Wireless Corp.....	482	Flechtheim & Co., Inc., A. M.....	485	Per-Con Mfg. Co.....	491
Allied Radio Corp. 482-489-490-492-503-507-509-510-512		Freshman Co., Inc., Chas.....	483	Potter Mfg. Co.....	490
Aluminum Company of America.....	467	<b>G</b>		Press Guild, Inc.....	499
American Radio & Merc. Co.....	496	General Radio Co.....	508	<b>S</b>	
American Sales Co.....	497	Gernsback, S. ....	502	Scott Transformer Co.....	Inside Back Cover
American Transformer Co.....	482	Gray & Danielson Mfg. Co.....	486	See Jay Battery Co.....	482
Arcturus Radio Co.....	506	Gustin-Bacon Mfg. Co.....	508	Setbuilders Supply Co.....	407-480
<b>B</b>		<b>H</b>		Shanklin Mfg. Co.....	482
Barawik Co., The 476-480-483-485-486-491-492-495-496- 498-501-503-505-506-507-509-510		Hammarlund Mfg. Co.....	487	Silver-Marshall, Inc. ....	406
Belden Mfg. Co.....	501	Hammarlund-Roberts, Inc. ....	408	Smith, B. Hawley.....	507
Benjamin Electric Mfg. Co.....	505	Hotel Lafayette .....	501	Southern Toy Co.....	496
Browning-Drake Corp. ....	496	Hotel McAlpin .....	490	<b>T</b>	
<b>C</b>		<b>I</b>		Tarbell System, Inc.....	498
Carter Radio Co.....	507	Illinois Transformer Co.....	503	Teleplex Co. ....	509
CeCo Mfg. Co.....	474	Independent Electric Works.....	480	Televocal Corp. ....	509
Central Radio Labs.....	494	<b>J</b>		Thodarson Elec. Mfg. Co. Inside Front Cover	
Chemical Inst. of N. Y., Inc.....	473	J-M-P Mfg. Co.....	505	Townsend Labs. ....	489
Chicago Radio Apparatus Co.....	505	<b>K</b>		Transformer Corp. of America.....	486
Chicago Stock Gear Works.....	495	Karas Electric Co. ....	489-493-507-509	Tyrman Elec. Corp.....	511
Clark & Tilson, Inc.....	495	Knapp Electric Co.....	481	<b>U</b>	
Consrad Co., Inc., The.....	491-498	<b>L</b>		Underground Aerial Systems.....	469
Consumers Radio Co. ....	503	Lacault, Inc., R. E.....	479	<b>V</b>	
Coyne Electrical School.....	506	Lacey and Lacey.....	507	Van Ashe Radio Co.....	486
Craftsman Radio Products.....	476	Leutz, Inc., C. R.....	410	<b>W</b>	
Cunningham, Inc., E. T.....	466	Lynch, Inc., Arthur H.....	501	Walker Co., The Geo. W.....	468
<b>D</b>		<b>Mc</b>		Webster Co., The.....	509
Daven Radio Corp.....	491-498	McSweeney Electrical Schools.....	595	Western Radio Mfg. Co.....	497
DeForest Radio Co., The.....	506	<b>M</b>		Wirt Co. ....	492
Deutschmann Co., Tobe.....	476	Massachusetts Radio & Tel. School....	483	<b>X</b>	
Diamond Radio Co.....	507	Metro Electric Co.....	465	X-L Radio Labs. ....	506
Directory Section of Radio News.....	477	Midwest Radio Corp. ....	Back Cover	<b>Y</b>	
Dresner Radio Mfg. Corp.....	494	<b>N</b>		Yaxley Mfg. Co.....	503
Dubilier Condenser Corp.....	470	National Co., Inc.....	491		
<b>E</b>		National Electrical School.....	486		
Electrad, Inc. ....	485-493	National Radio Institute.....	405-475		
Electric Specialty Co.....	497	New England Mills Co.....	494		
Electro-Chemical Company of America	486	Norden-Hauck, Inc. ....	483-495		
Elkon, Inc. ....	409	<b>O</b>			
Excello Products Corp.....	505	Oak Park Mfg. Co.....	494		
		<b>P</b>			
		Packard Radio Co.....	403		

Please say you saw it in RADIO NEWS

# FREE!

# MEN! Here's the dope you've been looking for

## HOW TO GET INTO THE RADIO BUSINESS-

J.E.S.

### Many Earn \$50 to \$250 a Week in Work That is Almost Romance



If you're earning a penny less than \$50 a week, clip coupon now for FREE BOOK! New 64-page book pictures and tells all about the Radio business, hundreds of opportunities—in work that is almost romance! YOU can learn quickly and easily at home, through my tested, proved methods to take advantage of these great opportunities! Why go along at \$25, \$35, or \$45 a week when you can pleasantly and in a short time learn how to hold the big-pay jobs?

#### Clip Coupon for Free Book

Don't envy the other fellow who's pulling down the big cash! My proven home-study training methods make it possible for you too to get ready for better jobs, to earn enough money so you can enjoy the good things of life. One of the most valuable books ever written on Radio tells how—interesting facts about this great field and how I can prepare you in your spare time at home, to step into a big-pay Radio job. GET THIS BOOK. SEND COUPON TODAY.

J. E. SMITH, Pres.,  
National Radio Institute  
Dept. 335  
Washington, D. C.



I Have Trained Hundreds of Men at Home for Big Radio Jobs. My Book Proves I Can Do the Same for You.



J. E. Smith, President,  
National Radio Institute,  
Dept. 335,  
Washington, D. C.

Dear Mr. Smith:  
Without obligating me in any way, send me your big FREE BOOK, "Rich Rewards in Radio," and all information about your practical home-study Radio Course.

Name..... Age.....  
Address.....  
Town..... State.....



## I Give You 6 Big Outfits of Radio Parts

With them you can build 100 different circuits—learn the "how" and "why" of practically every type of Radio set made. This kind of training fits you to step into the good jobs—sends you out an experienced Radio expert. When you complete, my Employment Department will help you get a real big Radio job like Graduate Edward Stanko, now Chief Operator of Station WGR, or Frank M. Jones, 922 Guadalupe St., San Angelo, Tex., builder and operator of Station KGFI and Manager of the best equipped Radio shop in the Southwest, or help you start a Radio business of your own like Richard Butler, 1419 No. 17th St., Phila., Pa., who made around \$500 a month compared with a small salaried, no future job as motorman when he enrolled.

My Radio Training is the Famous "Course That Pays for Itself"

Spare time earnings are easy in Radio almost from the time you enroll. G. W. Page, 1807 21st Ave. S., Nashville, Tenn., made \$935 in his spare time while taking this course. Al. Johnson, 1409 Shelby St., Sandusky, O., \$1,000 in four months, and he didn't know the difference between a condenser and a transformer when he enrolled. I'll give you a legal contract, backed by N. R. I., pioneer and largest home-study Radio school in the world, to refund every penny of your money if you are not satisfied, upon completing, with the lesson, and instructions received. Find out what Radio offers you—get the facts. Mail coupon—RIGHT NOW.

### ACT NOW—COUPON BRINGS MY

# FREE BOOK

Please say you saw it in RADIO NEWS



# Down to "BRASS TACKS" ON AUDIOS

(whether it hurts or not!)

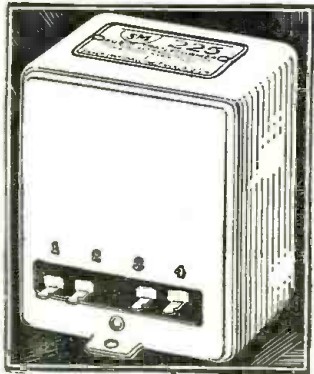
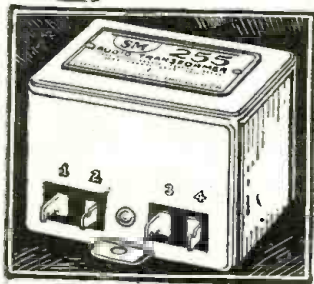

"Silver-Marshall unconditionally guarantees the new S-M Clough system audio transformers to give greater amplification, finer tone, and less distortion than any standard transformers marketed by any other American manufacturer."

**C**ONTRAST this straight-from-the-shoulder guarantee with the advertising phrases used by other manufacturers—not one dares offer the guarantee that S-M has given for two consecutive years—ever since the first 220 transformers were produced.

Not all radio fans have been able to attend the public comparative tests that S-M engineers have been making at the R. M. A. trade show and in the larger Eastern cities. These are the very surest proof that the new transformers are far superior to any and all other types. If you find it hard to believe that any transformers can be so far ahead of the audio equipment which you have been using, we can only say to you: "Buy a 225 and a 226, or a 255 and a 256; hook them up properly and test them. Then, if you're not satisfied that they are better than anything you've ever heard, return them to the factory for full credit." The fan unwilling to accept such an offer—content with transformers now far outclassed—is not the open-minded and progressive type to whom S-M appeals, and who will find in the new S-M transformers a quality of reproduction beyond his fondest expectations.

Research engineers—eminent designers—men who *know*, not guess—all acknowledge the supremacy of S-M audio transformers. This is a strong statement to make, but we back it up with a guarantee such as no other manufacturer has offered on audio transformer equipment. S-M Clough System audios are, in absolute fact, *two years ahead*—as truly as were the S-M 220's when, two years ago, they introduced the high frequency cut-off only recently adopted by other manufacturers. Remember this when selecting audio amplifying equipment—remember that S-M is the only manufacturer that has ever dared to make or encourage public comparative tests in comparison amplifiers open and accessible to minute, detailed examination by all listeners—and remember the above-quoted positive guarantee!

If you don't wish to build, yet want your radio to be custom made, with all the advantages that this implies, S-M will gladly refer your inquiry to an Authorized Silver-Marshall Service Station near you. If, on the other hand, you build sets professionally, and are interested in learning whether there are valuable Service Station franchises yet open in your territory, please write us.

**I**N the chart at the right, E is the two-stage curve for the large-size transformers (S-M 225, 1st stage; and 226, 2nd stage, \$9.00 each); D is that of the smaller ones (S-M 255 and 256, \$6.00 each). Note the marked advantage over A, B, and C—all standard eight and ten dollar transformers under equal conditions.

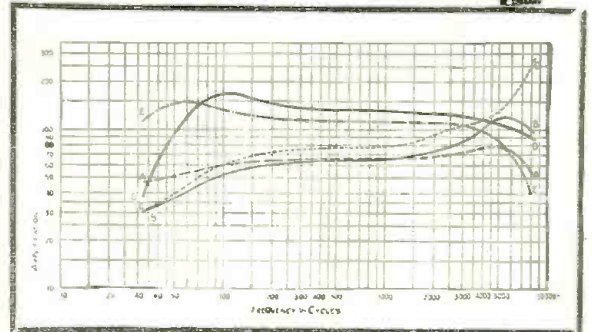

Are you getting "The Radiobuilder?" It's a little monthly magazine devoted to the interests of all who build sets. The coupon at the left will bring you a sample copy.

**SILVER-MARSHALL, Inc.**  
848 West Jackson Blvd., Chicago, U. S. A.

- Silver-Marshall, Inc.  
848 W. Jackson Blvd., Chicago, U. S. A.
- ...Please send me, free, the complete S-M Catalog; also sample copy of The Radiobuilder
  - For enclosed ..... in stamps, send me the following:
    - ... (50c) Next 12 issues of The Radiobuilder
    - ... (\$1.00) Next 25 issues of The Radiobuilder
  - S-M DATA SHEETS as follows, at 2c each:
    - ... No. 1. 670B, 670ABC Reservoir Power Units
    - ... No. 2. 685 Public Address Unipac
    - ... No. 3. 730, 731, 732 "Round-the-World" Short Wave Sets
    - ... No. 4. 225, 225, 226, 255, 256, 251 Audio Transformers
    - ... No. 5. 720 Screen Grid Six Receiver
    - ... No. 6. 740 "Coast-to-Coast" Screen Grid Four
    - ... No. 7. 675ABC High-Voltage Power Supply and 676 Dynamic Speaker Amplifier
    - ... No. 8. Sargent-Rayment Seven

..... Name  
..... Address

Please say you saw it in RADIO NEWS



**SM**

Build the  
**Leader**  
of all designs for custom building  
**The 1929 Screen Grid Laboratory Super**

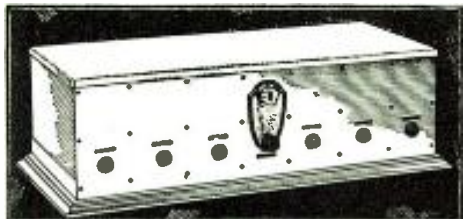

**710 Sargent-Rayment Seven**

A precision laboratory instrument for the veteran fan—with single-dial tuning feature and separate stage verniers. There are four screen grid t.r.f. stages—five circuits in all are tuned by the single illuminated drum. One knob controls volume. Each circuit is individually shielded, by-passed, and isolated from all others by heavy plates integral with the satin-silver-finished aluminum cabinet. Incorporates new Clough system audios with output filter. The kit is \$130.00 complete; or factory wired and tested, \$175.00.

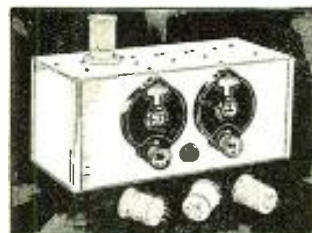

**730 Short-Wave Kit**

All the thrills of code and voice reception from many countries you can get night after night with the new S-M 730 "Round-the-World" Four. It has one screen-grid r.f. stage, regenerative detector (non-radiating), and two of the S-M Clough-system audio stages. Four plug-in coils fit a 5-prong socket, accessible on top of the aluminum cabinet. The complete 730 kit, including cabinet, is \$51.00; the 731 Adapter, the same kit without the two audio stages, \$36.00, converts any set to long-distance short-wave reception. The 732 Essential Kit is only \$16.50.

Through four consecutive years of progress which have altered the whole technique of radio reception, the designs of this famous series have steadily *led the way*. First the all-wave feature—then the first "shielded" super for home construction—then the unit amplifier catacomb—all carefully copied by imitators as the Laboratory Receiver marched on to *new* improvements. For 1929 are offered 3 screen-grid t.r.f. stages, ahead of a 65 kc. screen-grid amplifier—giving 10 kc. sharpness, one-spot convenience, and Clough-audio-system tone quality. The price of complete parts is only \$96.65. S-M 700 cabinet extra.

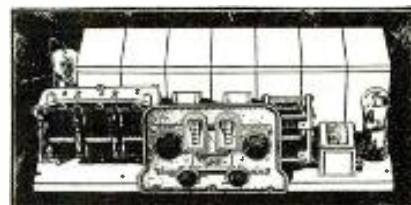

**New 720 Screen Grid Six**

Here is a set worthy in every way to stand with factory products selling for several times the price. Build one and test it—see how these three screen-grid r.f. stages cut past a powerful local and reach out after feeble signals a thousand or two thousand miles away on adjacent channels, and deliver them with loud-speaker volume! The audio amplifier uses two Clough system stages. The complete kit is only \$72.50 (two-tone metal shielding cabinet \$9.25 extra), or factory wired complete with cabinet \$102.00.

S-M 700 two-tone brown metal shielding cabinet; fits S-M 720 and 740 sets, and also the 1929 Laboratory Super. Price, with walnut-finished base, \$9.25.

**740 "Coast-to-Coast" Four**

The popular 4-tube circuit, which multiplies distance range by regeneration, now applied to ideal coils, forms the basis of

the 740. Entirely *non-radiating*—sharply selective to a 10-15 kc. band—powerful far beyond most factory-built 6's, owing to perfect utilization of a screen-grid t.r.f. tube—with all the matchless tone of the new S-M audios. S-M quantity production brings the complete kit price down to \$51.00, or for AC tubes \$53.00. Cabinet extra; see above.

**Power Amplifiers and B and ABC Power Supplies**

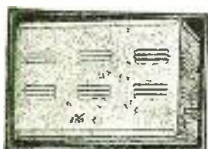

S-M Unipac Power Amplifiers provide power amplification with 210 or 250 tubes, either single or push-pull, and all (except 685) furnish B power (45, 90, 135 volts) to the receiver. The 681-210 (push-pull kit, \$87.00, wired \$102.00) is the most powerful single-stage amplifier made. The 681-250 at \$81.50 (\$96.50 wired) uses only one power tube instead of two. Type 682-210 (2-stage push-pull, \$102.00, wired \$117.00) uses a 226 tube in a stage preceding its push-pull super-power stage. Type 682-250 at \$96.50, (wired, \$111.50) is similar, but with one power tube only in the last stage. Type 685 (\$125.00, wired \$160.00) is the popular Public Address Unipac, using three stages for microphone, radio, or record pick-ups to cover crowds up to 10,000 people.

S-M Reservoir Power Units give high output, and uniform reliable operation. All models use standard tubes (not included in price). Complete

information is given in our big new catalog. For sets requiring 180 volts B, type 670B Reservoir Power Unit (kit \$40.50, wired \$43.50) delivers up to 60 m.a. with 22, 90, and 135 volts available, besides 22, 90 variable. The 670ABC (\$43.00, wired \$46.00) is similar but supplies also 1½, 2¼ and 5 volt AC filament voltage. Type 675ABC (\$54.00, wired \$58.00) gives 450 maximum voltage instead of 180, and has an adapter which allows a 210 or 250 type super-power tube to be used in the last stage of any receiver at all. Type 676 (\$49.00, wired \$55.00) Dynamic Speaker Amplifier amplifies the output of any receiver through a 250 tube, and supplies power to speaker field. Adding an S-M 676 to any dynamic speaker requiring 90 to 120 volts D.C. will improve tone and volume marvelously.

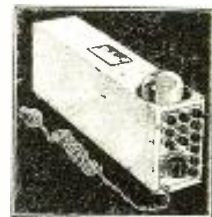

**We are National Distributors of S-M Products**

We carry for your convenience a complete line of S-M Radio Parts and Kits, including all the new Clough audio transformers. Any of these can be shipped at once, as well as the new Unipacs, power supplies, audio transformers, and other parts. Our new catalog will be a revelation to you—use the coupon and get it now! LIBERAL DISCOUNTS TO THE TRADE.

**Quick  
Courteous  
Service**

**Setbuilders Supply Co.**

**137 Romberg Building  
CHICAGO :: :: ILLINOIS**

Please say you saw it in RADIO NEWS

SETBUILDERS SUPPLY CO.  
137 Romberg Bldg., Chicago, Ill.  
Send me at once, free, your new catalog listing S-M and other radio parts, cabinets, consoles, and accessories of highest quality.

Name .....

Address .....

City ..... State .....

# 4 NEW HI-Q RECEIVERS

## Custom-built To Any Pocketbook!

**A** GAIN Hammerlund-Roberts opens the radio season with advancements in construction and performance that will be marveled at throughout the entire radio world.

This year, instead of merely one outstanding Custom-built receiver as in past years, we announce **FOUR** wonderful instruments—the result of the combined engineering efforts of the foremost parts manufacturers in America. **FOUR** brand-new models—a Junior D.C., a Junior A.C., a Master D.C. and a Master A.C. that establish a totally new standard in radio design.

The new Master Hi-Q typifies the marvelous efficiency of the entire line of 1929 Hi-Q's. A five-tube stage-shielded receiver that is built upon a solid steel chassis. Only the very finest parts in the industry are used, including the new screen-grid tube. Circuit is a new development with a **BAND-PASS FILTER**, which effects absolute **FLAT-TOP square cut-off TUNING** for the first time to our knowledge in radio history. **FLAT-TOP TUNING** with 10 K.C. selectivity! "Cross-talk" is impossible with this set, for the reason that it is impossible to receive more than one station at a time, even in large cities where many powerful stations are broadcasting!

**10 K.C. SELECTIVITY...ABSOLUTE FLAT TOP TUNING  
COAST-TO-COAST RECEPTION...NEW TONE QUALITY  
SCREEN-GRID TUBES . . . SHIELDED STEEL CHASSIS  
CONCEALED WIRING...SIMPLIFIED CONSTRUCTION**

This peak achievement of Hi-Q design is a real "coast-to-coast" instrument. Stations don't merely "swish" in as with

even the best of receivers. They absolutely "CLICK" in—sharp, clear, definite. No hum, no buzz, no oscillation—nothing but the pure, natural, clear-as-crystal signal exactly as it is delivered to the microphone.

There is nothing like this new Hi-Q Receiver available anywhere in any circuit at any price. Wonderful sensitivity. Wonderful selectivity. And tone quality that simply cannot be described.

The other three new Hi-Q 29 Receivers have similar qualities—each the fullest value available in the radio world—each a finer instrument than any ready-built receiver selling at \$50 to \$100 more money.



*Send Now for This New  
80-Page  
Construction Manual*

Biggest and most complete book ever published. Tells how to build the 4 new Hi-Q Receivers. Photos and diagrams illustrate every detail. Covers power amplifiers, tube and battery combinations, antennae, installation, short-wave adapters, house wiring and a wealth of other data on custom-built radio. Price 25c.

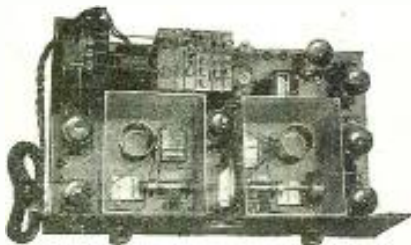

**JUNIOR A. C. HI-Q 29**

*A screen-grid, shielded receiver made with the finest parts available. Extremely selective, sensitive, tone quality unsurpassed, simplified construction.*

*Junior Hi-Q 29 complete without cabinet, \$54.35. Junior A. C. Hi-Q 29 complete without cabinet, \$103.95.*



**MASTER HI-Q 29**

*The outstanding feature of this set is the Hi-Q Band-pass Filter, which actually effects FLAT-TOP TUNING within a 10 K. C. band. Also screen-grid tubes, completely shielded, concealed wiring. Master Hi-Q 29 complete without cabinet, \$99.50. Master A. C. Hi-Q 29 complete without cabinet, \$151.80.*

*Any Hi-Q Model, whether in this delightful console or one of the Hi-Q Cabinets, makes a pleasing, decorative adjunct to the finest interior.*

**HAMMARLUND-ROBERTS, INC., 1182-C Broadway, New York**

*Associate Manufacturers*



*Please say you saw it in RADIO NEWS*

# ELKON REPLACEMENT RECTIFIERS Are Saving Radio Fans MILLIONS of DOLLARS



Type BNK for replacing the acid jars in Balkite Types N and K Trickle chargers

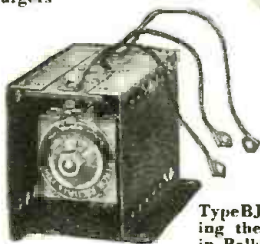

Type BJ for replacing the acid jars in Balkite Type J chargers



Type V-4 for replacing the rectifiers in 6 makes of Trickle chargers

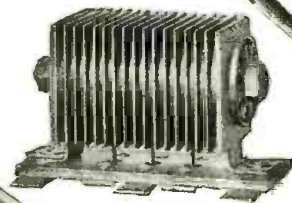

Type M-16 for replacing the rectifiers in 11 makes of "A" Eliminators and 3 Ampere chargers

Millions of dollars are invested in radio chargers, eliminators, etc. which would be lost if it were not possible to replace the rectifying units when their life has been exhausted. All Elkon Rectifiers are replaceable.

## HOW TO TELL IF YOUR RECTIFIER NEEDS REPLACING?

- If your trickle charger no longer keeps your storage battery up the way it did when it was new, you need a new rectifier.
- If your set has not the same pep as it did when you installed your "A" Eliminator, you need a new rectifier.
- Do not void the Manufacturer's Guarantee on your Balkite Power Units

The Elkon Replacement Units and those made by the Fansteel Products Company containing an Elkon Rectifier, are the only ones authorized for replacement of the acid jars in Balkite Power Units.

See your dealer today—there are thousands of hours of good reception left in your power units as soon as you have replaced your rectifier or acid jar with a new dry Elkon.

**ELKON, INC.**  
Port Chester, N. Y.  
Division P. R. Mallory & Co., Inc.



Type EBH for replacing the Bif type Tubes in "B" Eliminators



Every Elkon Rectifier goes through these exacting tests.

ELKON, Inc. - Radio Department  
281 Fox Island Road, Port Chester, N. Y.  
Please send me complete information on the Elkon Radio Products.

Name \_\_\_\_\_ Address \_\_\_\_\_

Please say you saw it in RADIO NEWS

# THE NEW LEUTZ UNIVERSAL TRANSOCEANIC

## 9 TUBES

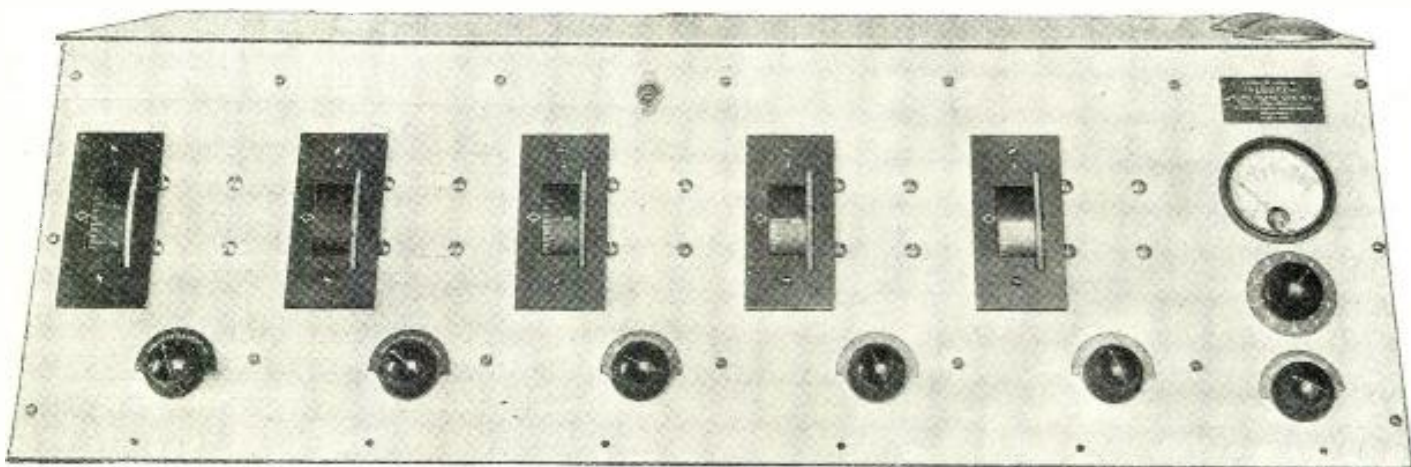

## WITH FOUR UX222's AND 2—UX210's OR 2—UX250's

### NEW IMPROVEMENTS

**T**HE UNIVERSAL TRANSOCEANIC has now been completely redesigned to use the new 222 Screened Grid Tubes in the four stages of radio frequency amplification. The total radio frequency amplification is now approximately 810,000 compared with only 10,000 obtained with the 201A tubes. This allows increased receiving range, greater volume on distant signals, and without any loss in selectivity. The detector circuit has been altered to use the new 200A type detector.

The audio amplifier has been further improved, a total of four stages being employed, two of these stages in a

push - pull system. The push - pull power amplifier will take either two 210 or two 250 power tubes, the most powerful audio amplifier one could desire. The undistorted output available for the loud speaker is approximately five times greater than a receiver using only one 210 or 250 power tube.

The 400/500 Volt BC Current Supply has been changed to the full wave type, using two 281 rectifier tubes for increased output. Provision has been made to use a Dynamic speaker if desired. The addition of the Leutz "A" Current Supply having a capacity of 3 amperes at 6 volts makes the set available for all electric operation.

PRICE — COMPLETELY CONSTRUCTED AND LABORATORY TESTED — \$250  
(NO ACCESSORIES)

Complete Constructional Blueprints—3 Large Sheets—\$2.00 Postpaid

A NEW RADIO BOOK for Custom Set Builders, Broadcast Listeners, Experimenters and Radio Engineers: "MODERN RADIO RECEPTION"—by Charles R. Leutz  
PRICE — \$3.00 — POSTPAID

384 PAGES—OVER 250 ILLUSTRATIONS—FULLY BOUND—6 x 9 INCHES  
Subject to refund if returned as unsatisfactory within 7 days

## C. R. LEUTZ, INC.

195 PARK PLACE, LONG ISLAND CITY, NEW YORK

Please say you saw it in RADIO NEWS



Editorial and General Offices, 230 Fifth Avenue, New York

Vol. 10

NOVEMBER, 1928

No. 5

## Future Progress in Television

By HUGO GERNSBACK

WHEN broadcasting first started in 1921, a great deal of speculation was rife as to what form the new art was to take and what could be expected from it. For a long time, broadcasting was rather crude, and no one had a definite idea what it was really all about. Only a good deal later did paid advertising creep into the programs, and we are still traveling along this road; either in the way of direct advertising, which seems to be on the decline, or the indirect form of advertising, better known under the term of "sponsored" programs. But, even today, exactly what ultimate form commercial broadcasting will take is not known, because changes are occurring continually while the art is progressing.

In television we are faced with a similar situation; for, just at present, no one knows exactly what it is all about, or what television will really mean to the world at large.

It is probably a foregone conclusion that, sooner or later, all broadcast stations will be sending out television impulses in one way or another. A number of stations—as, for instance, WGY and WRNY—are now broadcasting true television programs; while others—such as 8XAV at Pittsburgh and 3XK at Washington, D.C.—are broadcasting only "radio movies." The latter is not true television, according to my definition, because it is not "instantaneous sight at a distance," but rather "canned" sight.

When WRNY went on a regular schedule, August 12 last, with television, a tremendous amount of interest was created immediately in business quarters. One leading department store sent its representative to the station, to find out if it were possible to televise a fashion review which the store was sponsoring. The management was told that, unfortunately, this is not as yet possible, because the art has not progressed sufficiently; and, even if it had, there are not yet enough television receivers to make it worth while to put on such a review.

Another advertiser wanted to know whether the station would accept a contract to televise the images of articles of merchandise, interspersed with music and sales talk. A large publishing firm wanted merely to televise the cover of its latest book. A certain advertising agency wished to build a program around a well-known brand of cigarettes, televising the actual cigarette package from time to time.

Of course, most of these things are feasible today, in a way, and there is little doubt that, in the not-too-distant future, such commercial considerations will provide additional revenue for broadcast stations; but, at this time, simply because there are not enough television receivers in use, it would not be a paying proposition for advertisers, and they will be told so by any honest station management. Perhaps within six months, perhaps within a year, such commercial, "sponsored" television broadcasts will become an every-day occurrence and no one will think otherwise of them.

Of course, the serious difficulty with television today is that, at least on a single broadcast channel, we cannot have sound and vision at the same time. No simultaneous broadcast is yet possible. The few stations that are now broadcasting television have trouble even to switch rapidly from "aural" programs—those which can be heard—to "visual" programs. WRNY was perhaps the first that managed to alternate the "aural" program quickly with the images that are being televised. Less than a fraction of a second now intervenes during the switching from television to regular broadcasting, but this is, of course, not the final solution. We simply *must* have simultaneous television and "aural" broadcasting; but it is doubtful that we can have this on single broadcast channels for some time to come, unless an entirely new invention is made, and this, as yet, does not seem to be in sight.

It is, of course, quite possible to do it on two or more broadcast channels; but then, again, at the receiving end, we would need apparatus tuned in to different wavelengths, and that is evidently rather difficult to incorporate into a single set, although not impossible. While simultaneous television and "aural" broadcasting will

be comparatively simple on the low-wave channels, the trouble here is that for some years, this must be a strictly experimental enterprise; because, even though the larger manufacturers were to put forth a combined television and broadcast set to operate on the low waves, most of the listeners in the country would not be able to get such programs with their present sets. It would take years before such a change, from higher waves to lower waves, could be completely effected.

At one time, it was thought that broadcasting on the low waves would be the one cure-all for every radio ill. Unfortunately, this is not the case, mainly because there is such a thing as "skip distance." In large cities, it would be most difficult to receive the short waves and, on such wavelengths, few stations could be operated successfully as locals. A short-wave broadcast station located in New York or Chicago might be very powerful; yet no one in the same city could get the broadcasts at all, due to the "skip-distance" effect. The programs probably would come in much better two hundred miles away than twenty miles from the transmitter.

Of course, all of this discussion presupposes the dispelling of the synchronization bugaboo which, at the present time, is the nightmare of all television experimenters. It is like a similar situation which prevailed in the early history of radio, way back in the coherer days, when it was almost impossible at times to decipher the simple signals of the coherer, on account of static and other troubles. Very often the signals became totally unrecognizable, just as today, because of imperfect synchronization, the signals on the television disc are often badly blurred and unrecognizable. So, just as in the old coherer and crystal days the amateur had to use his imagination in order to decipher the code messages, so the present-day television experimenter must use his imagination to recognize the visual images. But these, of course, are the usual infantile diseases of a new art and will be speedily overcome as others have been overcome in allied arts.

That we will require an entirely new technique of televising various subjects, is, of course, a foregone conclusion. Just as there is a "radio personality"—because certain voices and certain sounds broadcast well and others do not—so it will be in television. Not everything is fit for televising; this holds true of faces as well as of objects. The matter of the subject, is, of course, all important. It was quickly found at WRNY, that certain faces, for instance, did not televise well at all. For instance, subjects with eye-glasses are entirely hopeless, because of their reflection. Oily skins broadcast better than dry skins. A woman with a large hat became a total loss during transmission, while a woman with a small close-fitting hat or none at all was far superior as a subject.

Also, if the subject is too small—such as for instance, a small toy monkey—it becomes unrecognizable. But on the other hand, if the subject is too large, the whole of it cannot be seen in the receiver, because of the small size of the image. Those received at the present time are usually only about one and one-half by one and one-quarter inches, being limited by the extent of the plate of the neon lamp, and size of the rotating disc.

On the other hand, engineers are now beginning to remedy the condition last mentioned, through enlarging the image by means of special lenses. Most of the trouble seems to lie in the fact that, at the present time, the neon tube does not give a sufficient amount of light to permit of enlarging the image; but this is also being overcome gradually. We probably will be soon using a multiplicity of tubes, concentrating their light on one part of the disc, and then enlarging the received image by means of lenses; or else improved tubes, giving greater light, will be developed.

It is quite possible that, before a year has passed, the 24-inch disc will have shrunk to a 5-inch diameter and the much smaller and sharper resulting image will be enlarged and thrown on a screen. Such television scenes will be much better in detail and more easily visible than the admittedly-crude images received at present.

THE EVENING STAR, WASHINGTON, D. C.  
**DAILY RADIO MOVING PICTURES WILL GO ON THE AIR THURSDAY**  
 Station WRNY Will Begin First Regular Television Broadcasting Into the Homes Ever Attempted.

NEW YORK HERALD TRIBUNE  
**TELEVISION WINS RADIO AMATEURS**  
 President of WRNY Demonstrates

THE NEW YORK TELEGRAM RADIO  
**Television Transmissions Start at Station WRNY**  
 Real Live Subjects, Not Photos, Used in Experiments of Local Station.

**Successful Television Programs**

**TELEVISION TEST HELD ON REGULAR BROADCAST BAND**  
 Standard Receiver Used in Experiment Opening Daily Broadcasts  
 Television Drama Shown With Music in Station WOR Test

**Broadcast by RADIO NEWS Station WRNY**

**Images Now Being Transmitted Daily on 326 and 30.91 Meters for Benefit of Radio Experimenters: Television Impulses Are Confined to 5,000 Cycle Limit**

by Robert Hertzberg Only  
 Ordinary Apparatus Used  
 Process Developed

By James S. Caulfield  
 Two television broadcasts within the past twenty-four hours officially opened a period of experimentation in the transmission of important moving objects and persons over broadcast channels from Stations WOR and WRNY.

The person to be televised sits in a booth facing three large photo electric cells, arranged in a triangle in a wooden frame, through the center of which an opening about the size of a "spanning" disc is cut. This device is a 200-ohm resistor at the rate of 450 revolutions per minute in front of a fall on the face of the disc. The light of the photocells is reflected into electrical currents corresponding in intensity to the light and dark portions of the skin and hair. This action may be compared to that of the microphone in transmitting the tones of the voice into electrical impulses. The impulses generated by the cells are amplified by a series of specially shielded resistance-coupled amplifiers.

**How to See Radio Image Broadcast by WRNY**

Operation of the television receiving apparatus described in the Journal, consists in keeping the driving motor at the same speed as that of the transmitter at station WRNY. Speed of the motor is controlled by the power source, a variable resistor connected in one side of the power line supplying the motor. The speed required is 450 revolutions a minute. Emphasis is placed on speed because it is the all-important factor for the successful operation of the receiver.

If the motor turns faster or slower than 450 r.p.m., no image will be seen. Keeping steady with the transmitter is known as synchronism. In the absence of automatic controls at this time for maintaining synchronism, the operation must be made by regulating the rheostat every few minutes. Exact synchronism is obtained when a blank margin appears at the base of the picture.

With short practice the operator will have no trouble keeping the picture from wandering off the frame. Automatic control apparatus now in development and will be available soon.

For efficient amplification, the signals should pass from the detector through a three-stage resistance-type amplifier, transformers being not so good.

**HOW TO TUNE IN.**  
 When WRNY is tuned in with headphones or loudspeaker, switch over to the neon lamp. The music or voice being broadcast will cause a fluctuation in the glow of the neon lamp, producing various linear distortions seen through the narrow observation window at the top and in front of the disc. When no signal is being received the tube glows steadily. It is better to tune in the headphones in circuit all the time in order to keep a close check on the character of signal received. The phones can be connected across the lamp terminals through a one-microfarad condenser.

When the transmission of television signals begins the frame will show at first a rapidly changing variety in geometric figures. As the motor speed approaches a comparison with the transmitter, the picture will begin to take shape. In advanced stages of the broadcast, the picture will be clear.

IT is with a feeling of great pride and satisfaction that Radio News is able to tell its readers that, through its own broadcast stations, WRNY and W2XAL, it inaugurated the first regular, daily, television broadcast service the world has known.

Numerous are the other organizations and the private experimenters who, both in the United States and in Europe, have staged individual demonstrations of spectacular nature; but, with the single exception of station WGY and its narrowly limited image transmissions, no one else has been able to offer a regular, scheduled service that the home radio experimenter can depend on as he now depends on the ordinary voice-and-music broadcasting.

The Radio News-WRNY television service is a real service to the experimenter for two important reasons:

first, the broadcast images can be picked up and reproduced with ordinary receiving equipment, on either the broadcast or the short-wave band; and second, the transmitted television signals are confined strictly to the 5,000-cycle margin to which all American broadcast stations are limited by law.

- 326-WRNY-920.**
- 11:00 A.M.—Keeping Fit — Jack O'Brien.
  - 11:30 A.M.—Television; Volga Instrumental Trio.
  - 12:00 M.—Menu, ham omelet.
  - 12:15—Augusta Spette, soprano.
  - 12:30—Television; Tommy Sparks, songs.
  - 2:00—Children's program.
  - 2:30—Television; E. Howard, violin; W. Seotfield, baritone; Pauline Gorini, soprano; B. Valentine, songs; J. Guzik, piano; J. Bauer, tenor.
  - 3:30—Television.
  - 7:00—Tiddbits—Valentine Erskine.
  - 7:05—Cookie Cohen, songs.
  - 7:20—Television broadcast.
  - 7:35—Houdini's Spirit Exposés—J. H. Kraus.
  - 7:45—Television broadcast.
  - 8:00—Edison hour of music; orchestra.
  - 9:00—Television—Hugo Gernsback at Philosop Hall, New York University.
  - 9:30—Television.
  - 9:35—Raymond Hunter, baritone.
  - 9:45—Television.
  - 10:00—Art String Ensemble.
  - 10:45—Fred Mayo, songs.
  - 11:00—Richard Orchestra.

The first regular television-broadcast program from the New York Times of August 21, 1928.

**KEEPING IN THE CHANNEL**  
 Successful television broadcasting on frequency bands less than 15,000 cycles wide has been held impossible by government radio authorities and many radio engineers, and practically all the television systems demonstrated so far have required that much width of channel "on the air," and considerably more.

The editors of Radio News themselves were not altogether convinced that recognizable images could be obtained with a mere 5,000-cycle signal, but they were willing and anxious

**BROOKLYN DAILY EAGLE**  
 The Long-Distance Test  
 The long-distance radio television broadcast from Station WRNY at Coatesville, N. J., to a tiny receiving set in New York University building, was a most interesting and successful one.

**WRNY Ready to Broadcast Experimental Television**

Experimental television broadcasting through station WRNY and its associated short-wave transmitter, 2XAL, operating on 326 and 30.91 meters, will positively begin sometime during the coming week, according to Hugo Gernsback, president of WRNY.

**WRNY Announces Schedule of Television Broadcasts**  
 Despite the current reports that television is not practicable it is actually being accomplished on a more or less regular schedule from WRNY.

**WRNY Broadcasts Television Images**

NEW YORK, Aug. 22.—Reception of television images transmitted over the regular broadcast wavelength of WRNY was demonstrated last night in Philosophy Hall, New York University.

to be shown. Credit for the achievement of the feat is due to John Geloso, chief engineer of the Pilot Electric Manufacturing Company, who worked day and night for more than three months designing, constructing and perfecting the televiser which is now in daily use at WRNY and W2XAL. Some of Mr. Geloso's preliminary experiments in the Pilot laboratories, in Brooklyn (New York City) were described in the September number of Radio News, to which the reader is referred. (Pages 221-256.)

Mr. Geloso received considerable assistance from the technical staff of Radio News, the members of which furnished many special television parts and offered numerous suggestions as to the construction and arrangement of the parts in

NEW YORK TIMES, MONDAY, AUGUST 13, 1928

**WRNY to Start Daily Television Broadcasts; Radio Audience Will See Studio Artists**

The first regular broadcasting of images by television over the radio from New York will begin tomorrow, it was learned last night from Station WRNY in the Hotel Roosevelt. WRNY, which is owned by The Radio News Magazine, has recently completed the installation of equipment for broadcasting images, and yesterday it conducted its first experimental broadcast.

The broadcasting was done from the station's transmitting plant at Villa Richard, Coytesville, N. J. The images sent consisted of the faces of John Geloso, engineer of the Pilot Electrical Company, and John Maresca, chief engineer of WRNY. The first broadcast began at 5:43 P. M. and continued until 6:30. The second began at 11 P. M.

There is no telling how many persons saw the images, according to Hugo Gernsback, President of WRNY. He estimated that there are about 2,000 sets in the metropolitan area equipped for television reception. Owners of sets unequipped for television heard the television

transmission as an intermittent high-pitched whirr, varying with the action before the transmitter.

Officers of WRNY saw the images at a set installed in a private home a few hundred yards from the transmitting station.

The television broadcasting scheduled to begin today will be made a part of WRNY's usual programs, Mr. Gernsback said. After a singer or other entertainer has finished, his or her face will be sent out over the air by television. Thus the schedule for the television will be the same as for the regular broadcasting of this station.

Considerable experimenting already has been made with television broadcasting by other stations. For some weeks C. Francis Jenkins has been transmitting silhouettes by radio, and other stations which have been developing the television field are WGY, at Schenectady; WLEX, near Boston, and WCFL, the labor station at Chicago.

Mr. Gernsback said that WRNY has received thousands of letters asking for television broadcasting.

the successful televiser. As a matter of fact, the whole project was sponsored by Radio News, with Mr. Geloso doing the actual experimental work. After performing successfully in the laboratory, the televiser described in the aforementioned article was moved on August 12 from Brooklyn to the WRNY transmitter house at Coytesville, N. J., just across the Hudson River from New York. An experimental receiver was set up a quarter of a mile from the transmit-

Left, facsimile of clipping from the New York Times of August 13, 1928, recording the news of the first successful television broadcasting through WRNY. The statement in the headline, "Radio audience will see the studio artists," was incorrect, however, as explained in the accompanying article.

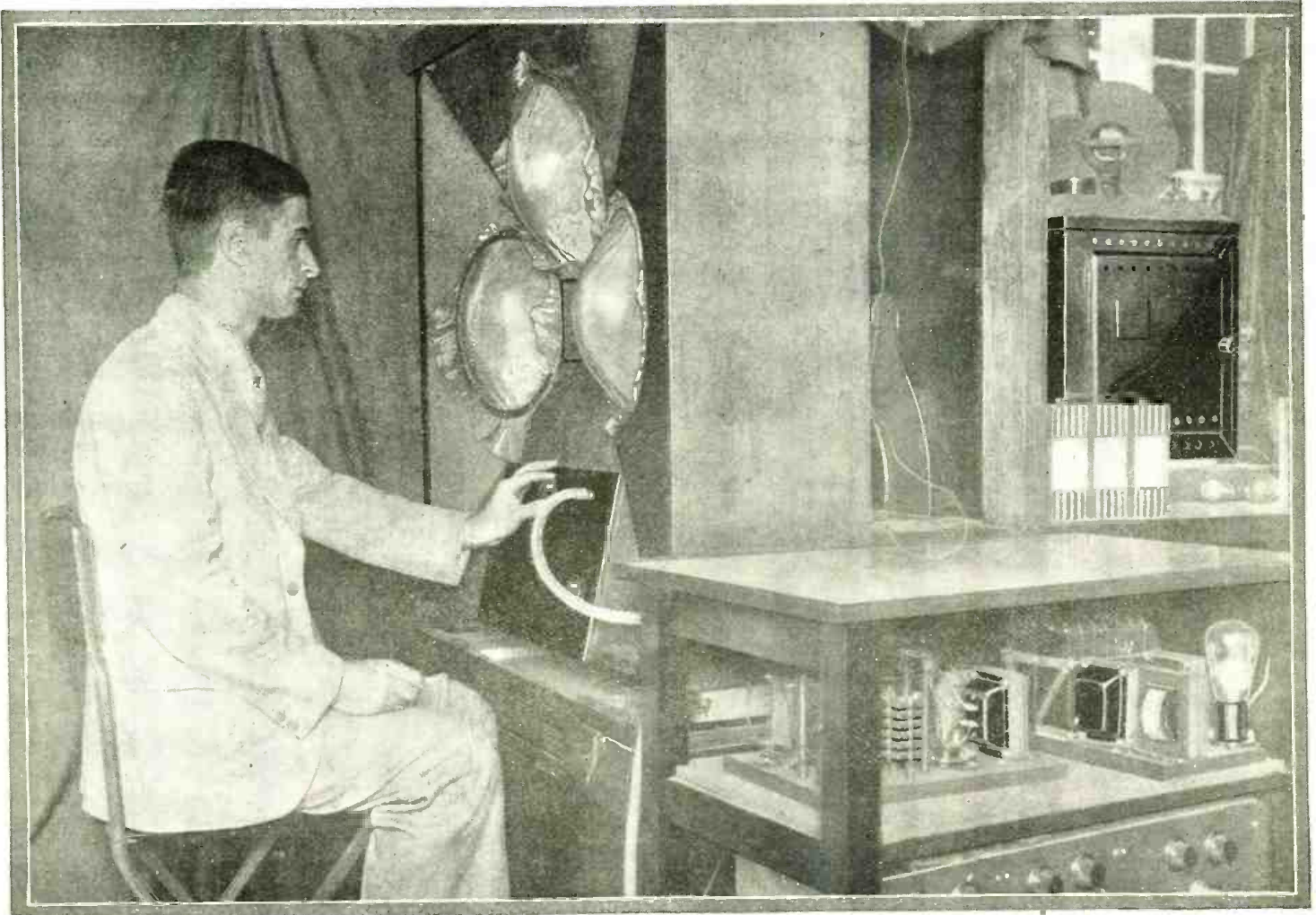

A general view of the Pilot televiser used at WRNY. The powerful arc light is in the square black can at the extreme right. The edge of the scanning disc is visible above the top of the small table, which holds the audio amplifiers for the photoelectric cells, which are the large round objects faced by the subject being tele-

vised; they are shielded by copper mesh. Above, the author of the accompanying article is shown adjusting one of the amplifier control rheostats, while he is being "televised." A shielded cable runs from the photoelectric cells to the amplifiers on the table.

ter, which is on the very edge of the Palisades cliffs, overlooking the entire island of Manhattan. Mrs. Geloso, wife of the inventor, was the first subject televised. Her husband, operating the receiver, tuned in the WRNY signals, adjusted the speed of his scanning disc, and emitted a loud whoop of joy when he recognized the clear image of his wife. These first images, about one and a half inches square, were slightly streaked and had a tendency to move "out of frame;" but they were comparable to average newspaper halftones in clarity. The broadcasting, it should be noted carefully, was done on the regular 326-meter wave of WRNY, and required no changes in the regular Western Electric transmitter.

On August 14, Mr. Geloso moved the receiver to the home of Hugo Gernsback, editor of RADIO NEWS, at 180 Riverside Drive, New York; this location is about five miles in an air line from the WRNY transmitter. With no opportunity for preliminary trial or adjustment, Mr. Geloso turned on the set at ten o'clock in the evening and again succeeded in reproducing the image of his wife, who was seated before the televisior at Coytesville. This feat was especially noteworthy because the transmitter and the receiver were operating on entirely-separated power lines, and absolutely no means of synchronizing the scanning discs was used. Because of the lack of perfect synchronization, the images wandered out of frame frequently; but for six or seven seconds at a time they were as clear as photographs.

#### DEMONSTRATION INTERESTS PUBLIC

After this private exhibition, it was decided to stage a public demonstration for members of the radio trade and of the press. The place chosen was Philosophy Hall, at New York University, 181st Street and University Avenue in the Borough of the Bronx (New York City) and the date, August 21, 1928. This demonstration was a marked success, having been attended by more than 600 people, all agog with interest, and many were unable to find room in

*John Geloso, seated before a complete broadcast-and-television receiver, viewing through the square opening near the top of the cabinet, the scanning disc is about six inches behind the front panel of the set. An experimenter who is just starting in television should not build his apparatus into a large cabinet like this one until he has first succeeded in obtaining good results with a rough table layout. This receiver is the one used in the public demonstration at New York University.*

the hall. Although no automatic system of synchronizing the transmitting and receiving discs had yet been installed, Mr. Geloso managed to obtain satisfactory images of the subjects televised. The images were not perfect, but as Mr. Gernsback remarked in his introductory address, which was broadcast by remote control from the hall over WRNY previous to the television transmission, television is now in the "spark-coil-and-coherer stage," and too much cannot be expected of it for the present.

The first printed radio program listing television transmissions as a regular feature appeared on the morning of that day; a typical program, taken from the *New York Times* of August 21, is reproduced on the first page of this article. All the WRNY programs which have appeared since that date have carried the exact time of each television broadcast.



At present, it is *not* possible to broadcast the images of the artists who are performing in the WRNY studio in the Hotel Roosevelt, New York. Because of land-line problems the televisior must be close to the actual broadcast transmitter; so only the images of the WRNY operators and other persons at the transmitting room will be broadcast, for some time to come. At the start of each transmission, a white card bearing the letters WRNY in heavy, black letters is held before the televisior; so that the experimenter can make the required preliminary adjustment on his scanning disc to receive the transmitted image of a human television subject.

#### SCHEDULE NOW FOLLOWED

Television images are broadcast simultaneously by WRNY on 326 meters and by W2XAL on 30.91, the first five minutes of every hour that the stations are on the air. The complete schedule of television transmissions is as follows (cut this out and save it, for it will be very useful when you make your own television receiver, as described elsewhere in this number), and all times are Eastern Standard; add five hours for Greenwich time:

*Mondays:* 7.00 to 7.05 a. m.; 8.00 to 8.05 a. m.; 11.00 to 11.05 a. m.; 12.00 (noon) to 12.05 p. m.; 2.00 to 2.05 p. m.; 3.00 to 3.05 p. m.; 4.00 to 4.05 p. m.; 5.00 to 5.05 p. m.; 6.00 to 6.05 p. m.; 6.40 p. m. to 7.00 p. m. (20-minute period).

*Tuesdays:* 7.00 to 7.05 a. m.; 8.00 to 8.05 a. m.; 11.00 to 11.05 a. m.; 12.00 (noon) to 12.05 p. m.; 7.00 to 7.05 p. m.; 8.00 to 8.05 p. m.; 9.00 to 9.05 p. m.; 10.00 to 10.05 p. m.; 11.00 to 11.05 p. m.; midnight to 12.20 a. m. (20-minute period).

*Wednesdays:* 7.00 to 7.05 a. m.; 8.00 to 8.05 a. m.; 11.00 to 11.05 a. m.; 12.00 (noon)

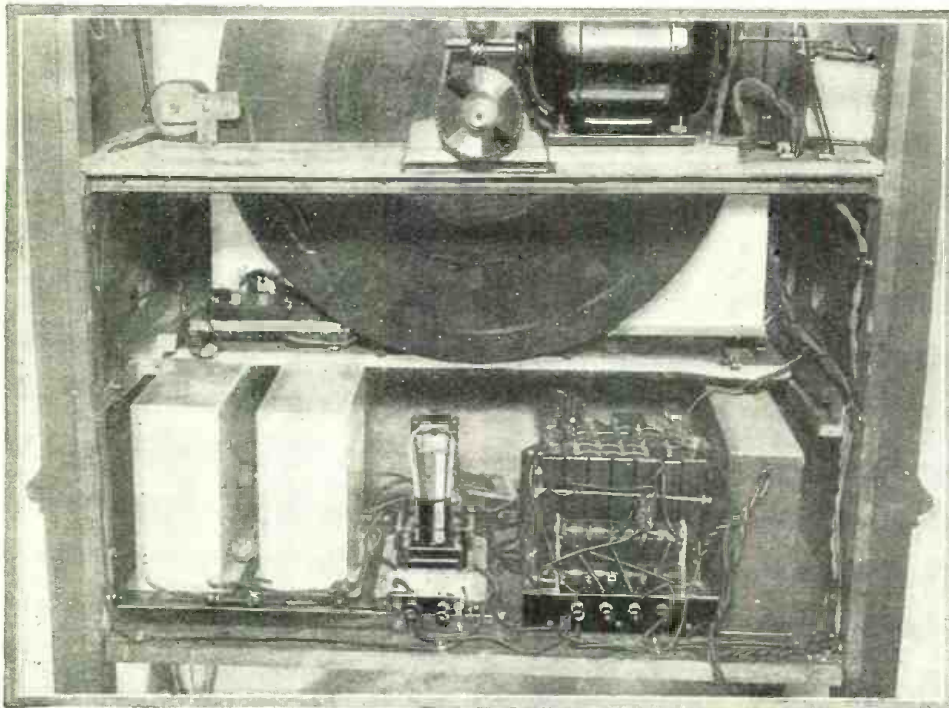

*The lower half of the "works" of the receiver shown above. In the lower left corner is a three-stage resistance-coupled amplifier, with each stage individually shielded. In the right corner is a power-pack supplying "B" potential to the amplifier tubes. The broadcast tuner, of straight T.R.F. design, is in a can behind the disc*



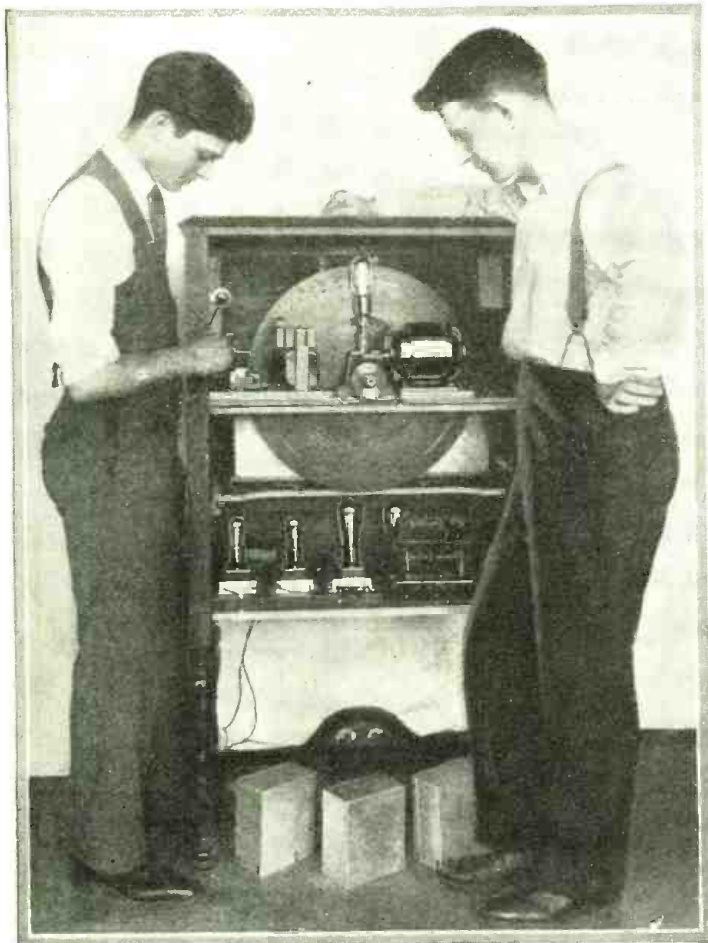

What the back of the television machine shown on the opposite page looks like. The scanning disc, driving motor and neon glow-tube occupy the top half of the cabinet; while the audio amplifier and power pack fill the bottom. The three cans at the feet of Mr. Celoso (left) and his assistant, Frank T. Sullivan, are the shields for the audio-amplifier stages. The glow-lamp is in front of the scanning disc, directly under Mr. Sullivan's right fist. The broadcast tuner itself is behind the scanning disc.

is an opening about six inches square. These cells (which are the subject of a separate article on page 221 of the September number of Radio News, previously mentioned) are completely shielded on all sides; the exposed portions of their bulbs are covered with copper mesh, while the wooden containing box is lined with sheet copper. The mesh acts as an electrical screen, but does not keep out light.

On the other side of the frame holding the photoelectric cells is a flat aluminum scanning disc, 24 inches in diameter, pierced by a spiral of 48 holes. This rotates, at the rate of 450 revolutions a minute, in front of a powerful electric arc, the light of which passes through the holes and falls on the face of the subject. The side of the disc facing the arc is "masked" in such a manner that only one hole at a time passes light on to the subject. As soon as one hole is swept past the arc it runs behind the mask, just as the next hole of the spiral comes into view. As the holes are arranged in a spiral (each being slightly nearer the center of the disc than the preceding one), a series of 48 separate rays of light, one directly under and following the other, flash across the subject's face (see page 222 of the September issue for a fuller explanation). These rays of light are reflected into the photoelectric cells, which produce electrical currents corresponding in intensity to the amount of reflection from the light and dark portions of the skin and hair; this action may be compared to that of a microphone in translating the tones of the voice into electrical vibrations. The impulses generated by the cells are amplified by a bank of specially-shielded resistance-coupled amplifiers, which in turn feed the modulator tubes of the broadcast transmitters. The latter send out signals which are plainly audible in any ordinary broadcast set tuned to 326 meters, or in any short-wave set adjusted to 30.91 meters—within reception range of the station—as a peculiar noise with a fundamentally low-pitched note, mingled with shriller ones, depending on the character of the image. (Continued on page 490)

short-wave set. RADIO NEWS has available a number of free blueprints of inexpensive short-wave receivers; if you already do not own a short-wave set, drop us a postcard or a letter and we will send you a set of blueprints free of cost. (Ask for blueprint No. 58, if in doubt.)

**SIMPLICITY OF THE TRANSMITTER**

The Pilot televisior now in use at WRNY

is comparatively simple in construction, as television apparatus goes. As can be seen from the picture at the bottom of page 413 it consists of four fundamental units: a source of light (an arc lamp), a scanning disc, a nest of three large photoelectric cells, and an amplifier for the output of the latter.

The person to be televised sits in a cloth-covered booth facing the photoelectric cells, which are arranged in a triangle in a wooden frame, through the center of which

to 12.05 p. m.; 2.00 to 2.05 p. m.; 3.00 to 3.05 p. m.; 4.00 to 4.05 p. m.; 5.00 to 5.05 p. m.; 6.00 to 6.05 p. m.; 7.00 to 7.05 p. m.; 8.00 to 8.05 p. m.

**Thursdays:** 7.00 to 7.05 a. m.; 8.00 to 8.05 a. m.; 11.00 to 11.05 a. m.; 12.00 (noon) to 12.05 p. m.

**Fridays:** 7.00 to 7.05 a. m.; 8.00 to 8.05 p. m.; 11.00 to 11.05 a. m.; 12.00 (noon) to 12.05 p. m.; 2.00 to 2.05 p. m.; 3.00 to 3.05 p. m.; 4.00 to 4.05 p. m.; 5.00 to 5.05 p. m.; 6.00 to 6.05 p. m.; 7.00 to 7.05 p. m.; 8.00 to 8.05 p. m.; 9.00 to 9.05 p. m.; 10.00 to 10.05 p. m.

**Saturdays:** 7.00 to 7.05 a. m.; 8.00 to 8.05 a. m.; 11.00 to 11.05 a. m.; 12.00 (noon) to 12.05 p. m.; 3.40 to 4.00 p. m. (20-minute period); 7.00 to 7.05 p. m.; 8.00 to 8.05 p. m.; 9.00 to 9.05 p. m.

**Sundays:** 7.00 to 7.05 a. m.; 8.00 to 8.05 a. m.; 11.00 to 11.05 a. m.; 12.00 (noon) to 12.05 p. m.; 2.00 to 2.05 p. m.; 3.00 to 3.05 p. m.; 4.00 to 4.05 p. m.; 5.00 to 5.05 p. m.

Most of the periods specified are of only five minutes duration, but it will be noted that there are also three twenty-minute periods, one each on Monday, Tuesday and Saturday. These longer transmissions enable the experimenter to adjust his receiving apparatus more carefully and to receive a greater percentage of perfect images than the shorter five-minute broadcasts allow.

An announcer breaks in several times, during each twenty-minute period, to tell what is being broadcast. WRNY now televises the following: faces of living people, the WRNY placard previously mentioned, a moving toy monkey, and a moving "roly-poly man."

Those living in the vicinity of New York may tune in WRNY's regular 326-meter wave on their regular broadcast receivers; experimenters outside of the New York local area can do best by using a simple

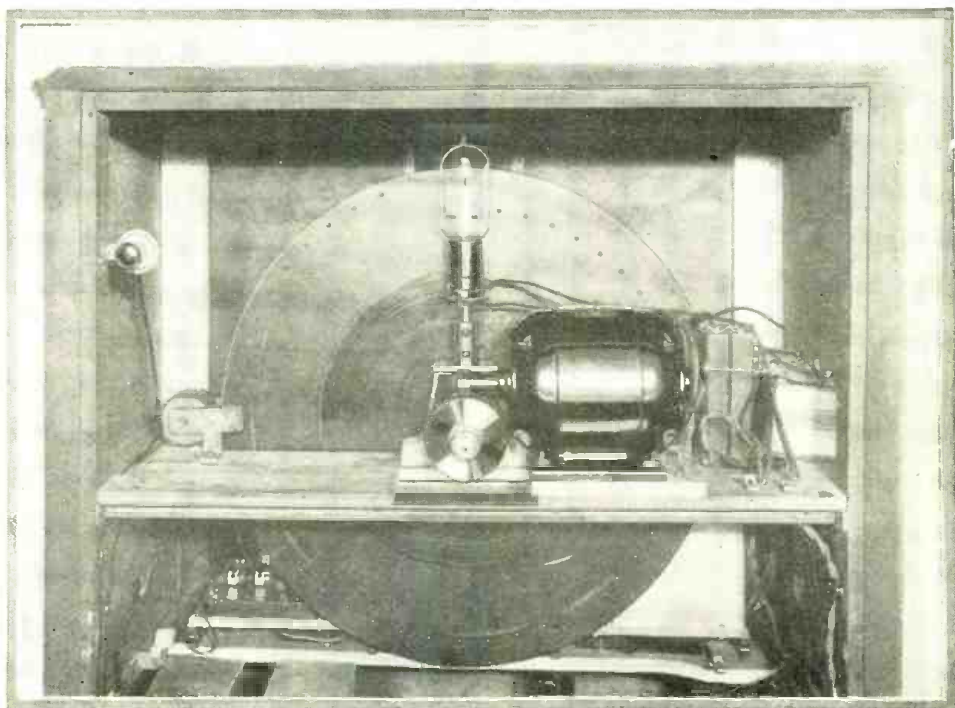

A close-up of the scanning machinery; the synchronous A.C. motor, revolving at 1800 r.p.m., turns the disc through a 1:4 reduction worm gear. The neon glow-lamp is supported on an adjustable stand immediately behind (here seen in front of) the scanning disc. The disc is 24 inches in diameter, has a spiral of 48 holes, and turns "counterclockwise" at 450 r.p.m.

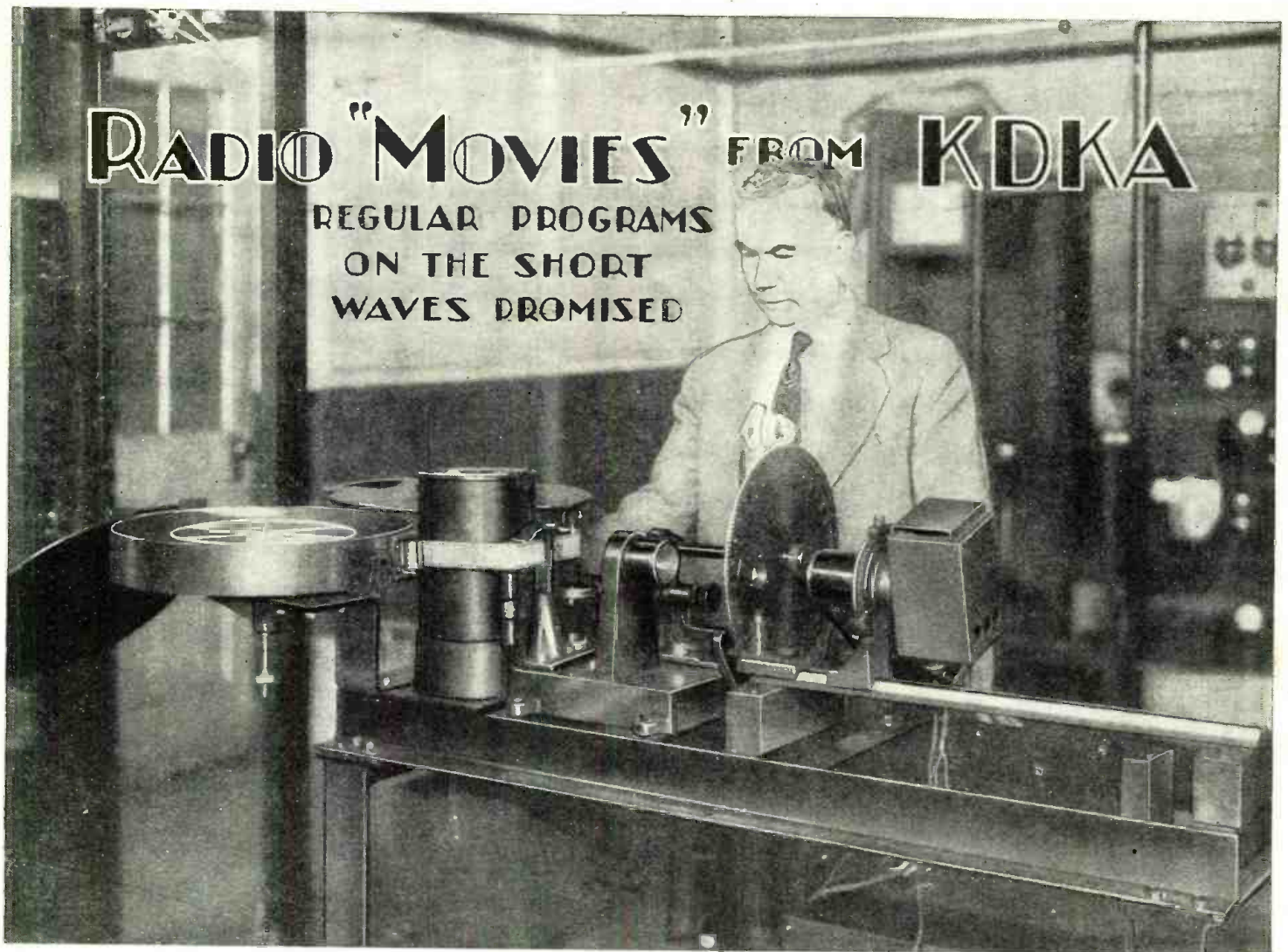

Above: Dr. Frank Conrad, research engineer of the Westinghouse Company, standing behind his "radio-movie" transmitter.

ON August 8 the Westinghouse Electric and Manufacturing Company demonstrated a system of "radio movies" to members of the press and a group of distinguished radio men at station KDKA, East Pittsburgh, Pa. The demonstration was very successful and convincing, but the daily newspapers which mistakenly heralded it as the "first transmission of motion pictures through the air in the history of the world," either overlooked or were in entire ignorance of the work which C. Francis Jenkins had been doing in Washington for months before the Pittsburgh showing; as they gave him no credit at all for his own previous successful broadcasting of "movies." RADIO NEWS wishes to straighten out this matter merely as a matter of historical interest, and not to disparage in any way the very admirable achievements of the Westinghouse research engineers.

The Jenkins "radio-movie" apparatus was the subject of the front-cover illustration of RADIO NEWS for August, 1928, and was described in great detail in a three-page article in that number. A member of the editorial staff who made a trip from New York to Washington, for the special purpose of examining the equipment, reported his observations in that article. The reader who is interested in the general subject of animated radio telephotography (the correct designation of "radio movies") is referred to this for the details of the

Jenkins system, which works very well and which is now on the air, on short waves, three times a week.

The statement issued by the Westinghouse company at the time of the demonstration promised that regular "radio-movie" transmissions through KDKA would commence "within a few weeks," although no data concerning wavelength or details of the transmitting system were given. The New York office of the company yielded the more definite information that one of KDKA's short-wave channels will be used. This will be good news to thousands of radio experimenters all over the world, as KDKA is the most consistent and reliable short-wave broadcaster on the air today.

In the demonstration of August 8, the "radio-movie" signals traversed a distance of about four miles: two miles over wires from the television laboratory to the broadcast station proper, two miles away, and two miles back to the same laboratory by radio. They could just as well have been sent a greater distance; but the object was to show the operation of the whole system, both transmitter and receiver, to the assembled guests.

#### METHODS AND APPARATUS

As explained by the Westinghouse engineers, the operation of the "radio-movie" system is as follows:

Photography in its simplest form consists of the reproduction of spots of light and

shadow in the same arrangement which they occupy in the subject photographed. In screening a motion picture, a roll of film is operated at a speed which sends sixteen pictures a second before a projecting beam of light. Because of the structure of the human eye, if pictures follow each other in a regular series at the rate of eight or more per second, the eye sees a single moving picture. To broadcast the "radio movies" requires all this, with the addition that the spots of light must be transformed into electrical vibrations, which are in turn caused to modulate a radio "wave." In the reception of the pictures, the process is reversed. The electrical energy representing the radio "wave" is picked up, amplified, demodulated, and the electrical vibrations are returned to the form of lights and shadows, which, when viewed by the human eye, constitute the "radio movie."

In the first step of the transmitting process, a sharp beam of light traverses each picture or "frame" on the roll of film, in parallel paths, 60 times. A sixteenth of a second, the length of time each "frame" is kept in view, is required for this scanning. A sixty-line picture is as clear as the usual good newspaper halftone.

The sharp beam of light is produced by the interposition of a scanning disc which has a series of minute square holes arranged in a circle near its rim. This type of scanning disc should be distinguished from the usual television disc in which the holes are

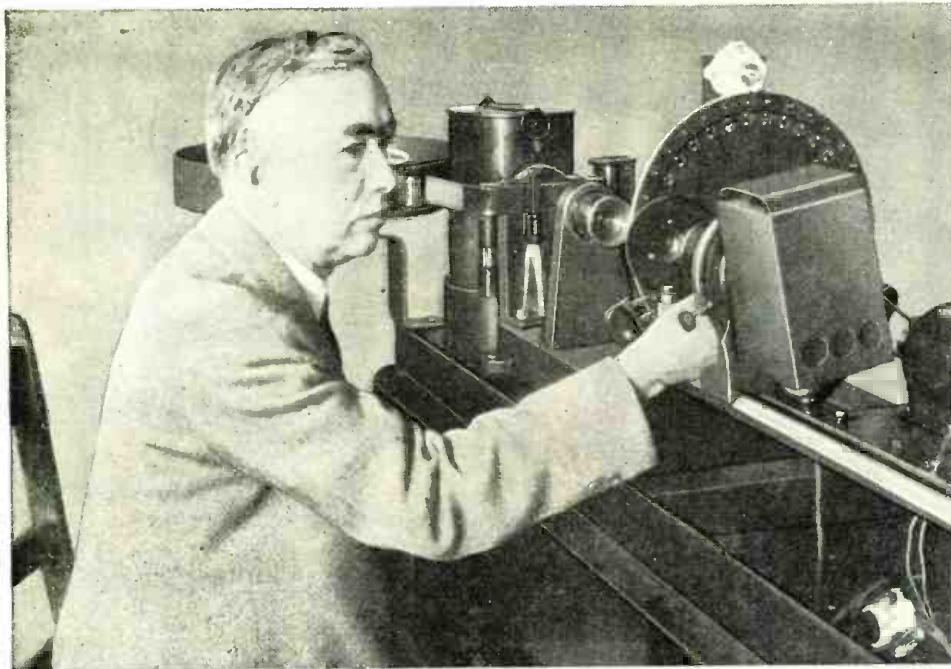

Dr. Conrad at his "radio-movie" apparatus. The square can next to his right hand contains a powerful lamp which produces the light used for "scanning" the movie film. Pictures of the receiver are not yet available.

arranged in a spiral. A circle of holes is used in the Westinghouse system, and not a spiral; because the movie film itself is steadily moving past the beams of light, and thus the whole surface of the film is scanned. In a television system such as WRNY uses, the subject (corresponding to the pictures on the film) is stationary; so the scanning holes must be arranged spirally in order to cover the subject completely.

The Westinghouse disc is so arranged that all light is excluded from the film, except that which comes through the square holes. The disc turns very fast and, as it turns, flings the beams of light across each frame from top to bottom (side to side of the picture), so that the whole is "scanned."

The beam of light passing through the film falls into an "electric eye," or light-sensitive cell, which is not unlike an oversized incandescent lamp in external appearance. Within the cell is a thin coating of caesium, a rare "alkaline" metal. The amount of light falling on this cell determines the amount of current passing through it; the result is that each individual beam of light produces an electrical impulse which varies in intensity directly in proportion to the amount of light (or shade) at the point of the film through which it is passing. The impulses are amplified and then conducted to the broadcast transmitter.

According to Dr. Frank Conrad, who designed the Westinghouse "radio-movie" apparatus, the frequency of the picture impulses thus obtained ranges from 500 to about 60,000 cycles. The width of this band makes the application of the present system to the regular broadcast band out of the question; on the short waves, of course, transmission can be handled more easily.

#### THE RECEIVER

The receiving end of the system appears to be practically identical with other existing disc systems. The received impulses are detected and amplified and then led to a mercury-vapor lamp, which corresponds to the neon-gas glow-lamp of less expensive receivers. The mercury lamp goes bright or

dim as fast as the current changes, and its light at any instant is in proportion to the light that the electric eye "sees" in the same instant at the transmitter. To return the dots of light to their original pattern, a revolving scanning disc is used. This disc must, of necessity, contain its holes in a spiral arrangement, in order to build up the necessary 60 lines corresponding to the scanning lines at the transmitter; and the lamp is mounted, presumably, at the top, in order to obtain proper scanning of the reproduced image.

According to the statement released by the Westinghouse company, the use of a "mercury arc" lamp permits the received images to be projected upon a ground-glass screen. As the company is decidedly reticent about divulging the details of the receiver, we cannot give the exact dimensions

of the received images in this article; but, as soon as the information is forthcoming, RADIO NEWS will publish it.

The accompanying illustrations give a good idea of the construction of the transmitting apparatus; the picture bearing title shows Dr. Conrad standing behind the machine, while the lettered picture on this page shows a close-up of the parts. L1 is a powerful lens which concentrates the light from an incandescent lamp (contained in the square-shaped can in front of Dr. Conrad's arm in the title cut). The light beam passes through the square holes of the scanning disc D and, after coming out on the other side of the disc, is further concentrated by a second lens, L2. The tiny "pin-head" beam from this lens sweeps across and through the film F, which is moved horizontally from one reel to the other by a suitable ratchet mechanism which engages the slots in its sides. The photoelectric cell P is contained in a shield can, located between the film reels.

The construction of the scanning disc may furnish home television experimenters with an idea. The minute scanning holes are drilled, not directly through the disc itself, but through little individual metal tabs which are adjustable and attached to the disc. Of course, a circle of larger holes is first drilled into the disc, and these allow the light from the tiny square holes to pass through.

The Westinghouse company is definitely contemplating the manufacture of commercial "radio-movie" receivers, according to its announcement; when these are ready they will be sold through the Radio Corporation of America. A Westinghouse official, when questioned by Radio News, stated that no one in the company has any idea when the instruments will be ready, as the experimental work on them has not yet been completed and much remains to be done.

At present station SXAV, using one of the several short-wave transmitters at East Pittsburgh, is transmitting these "radio movies," though as yet not on any regular schedule. Owners of short-wave receivers can probably pick up the signals if they will tune to 62.5 meters.

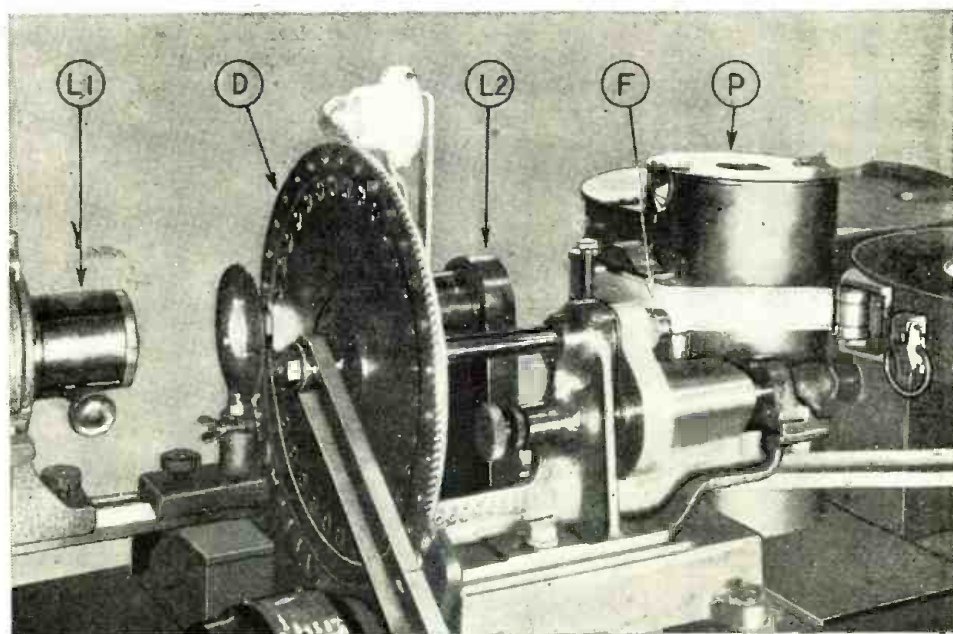

A close-up of the "radio-movie" transmitter: L1, lens concentrating a powerful beam of light on the scanning disc D; L2, second lens producing sharp "pinpoint" of light on the film F. P is the photoelectric cell.

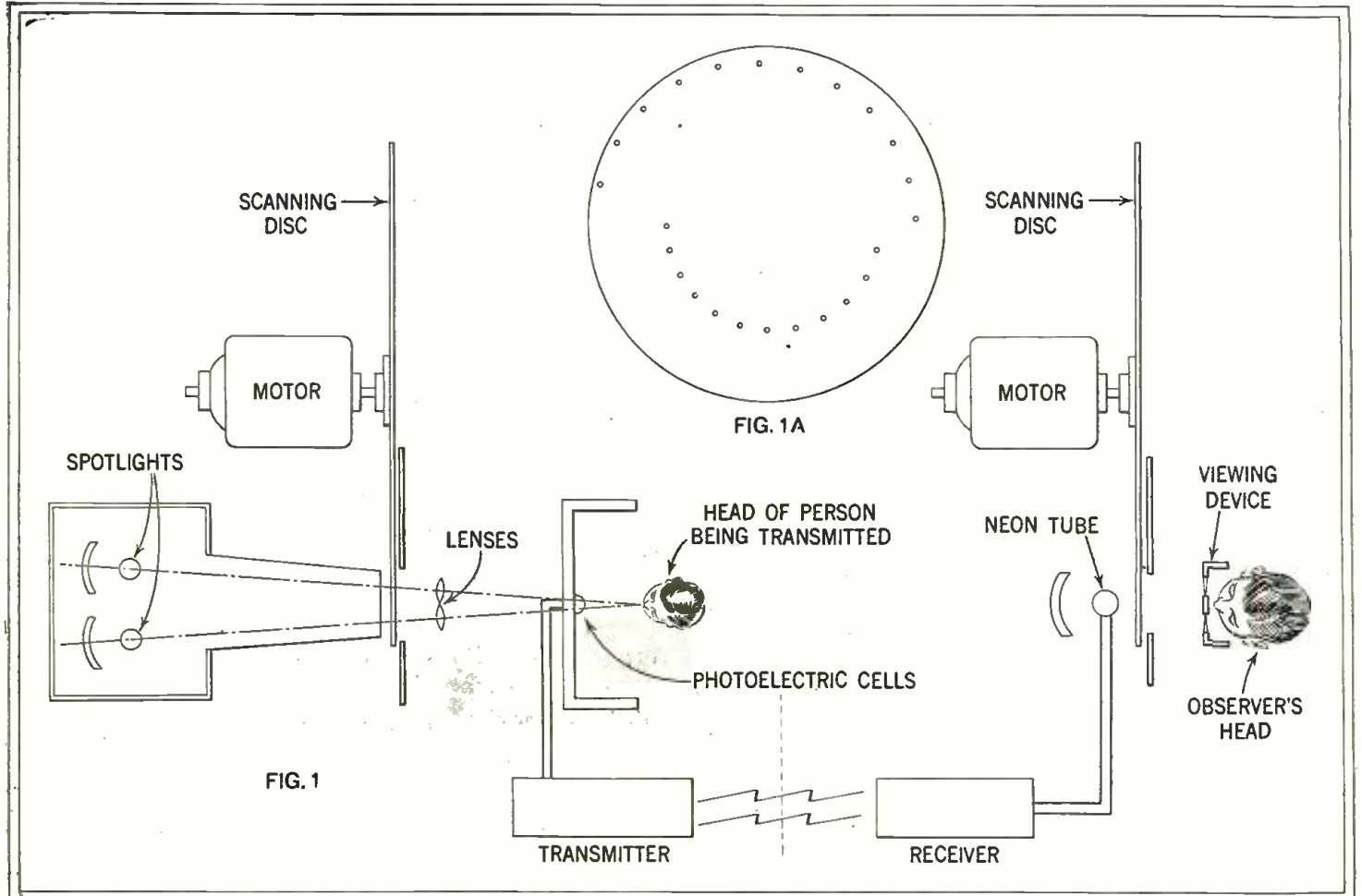

The "Stereoscopic" transmitter is shown in diagram form at the left, and the receiver at the right. The disc (Fig. 1A) scans two distinct images, one for each eye.

# How "Stereoscopic" Television Is Shown

John L. Baird Produces Moving Images Which Are Given the Appearance of Solidity

By R. F. Tiltman

THE last few months have witnessed spectacular advances in television. In June, John L. Baird demonstrated before Professor Fleming and other distinguished scientists and press representatives the transmissions of persons illuminated only by ordinary daylight, thus removing television from the laboratory to the

out-of-doors. This was followed almost immediately by transmission of objects in natural colors, as described in RADIO NEWS for October; and now, immediately on top of all this, comes the demonstration of stereoscopic television.

Television images in, apparently, three dimensions were demonstrated for the first

time on August 10 in the Baird laboratories in Long Acre, before an audience of scientists and representatives of the press.

### THE PRINCIPLE OF THE STEREOSCOPE

Stereoscopic television gives the image the appearance of solidity or depth, so that it does not look like a flat picture, but like an actual living object. The stereoscope does the same thing for photography and, in explaining stereoscopic television, we must first of all examine the principles of stereoscopy. The appearance of solidity or depth which we have arises from the fact that we view the exterior world through two eyes, each of which sees the scene from a slightly different viewpoint. The mind combines these two different images into one, and it is the blending of the left-eye and right-eye images that gives the impression of depth.

In the stereoscope, with which we are all familiar, two photographs, taken by cameras separated a distance equal to or greater than the distance between the two eyes, are placed side by side in a viewing device consisting of two prisms, so arranged that on looking through the prisms the images are converged and made to overlap. The extraordinary result is then obtained that, instead of our seeing two overlapping images, the mind combines these two dissimilar pictures into one composite view; and this

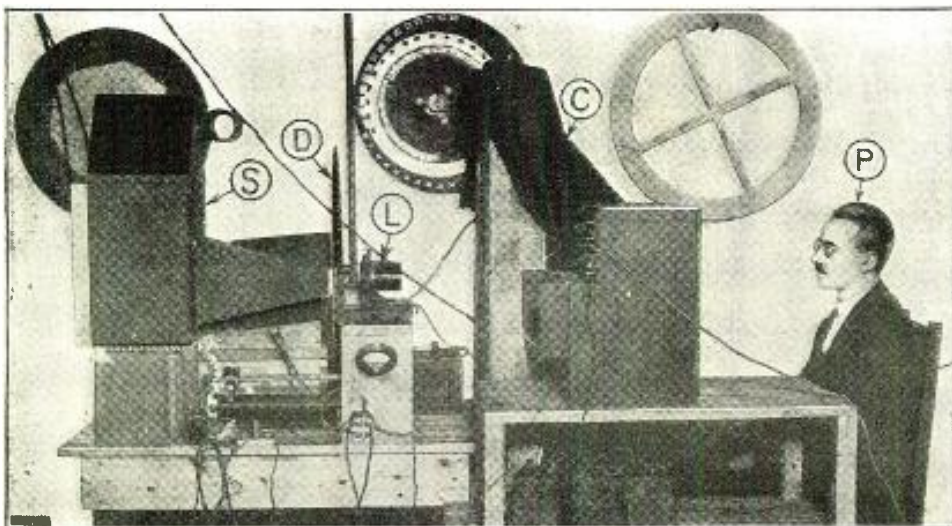

In this picture of the Baird transmitter, the photoelectric cells are in the box at the right; S, light-source; D, scanning disc; L, lens; C, cloth covering cells; P, subject undergoing television.

composite view does not appear as a flat photograph, but gives the observer the impression that he is looking into the actual scene itself. The illusion is very striking.

#### A DOUBLE TELEVISION IMAGE

By applying the stereoscopic principle to television, it has now become possible to transmit television images with all the appearance of depth and solidity; and, by a further combination of colored television with stereoscopic television, the complete illusion of images in natural colors, and with depth and solidity becomes possible. All this has recently been demonstrated in the Baird laboratories.

The transmitting apparatus consists of a disc, perforated as shown in Fig. 1A with two spirals; the first spiral being arranged round one-half of the circumference of the disc. The other spiral occupies the other semi-circumference, about four inches further in; the separation corresponds to the distance between the eyes of a human being.

Behind the disc, when it is mounted in the transmitter, as shown at the left of Fig. 1, is arranged an intense source of light. In front of the disc, and in line with the light-source, a lens is placed in such relation to the disc that a spot of transmitted light is caused to traverse the object. This arrangement is duplicated, so that each spiral has its lens and light-source; thus, two light spots traverse the object alternately, and two images are transmitted, one for the left eye and one correspondingly for the right eye.

At the receiving station a similar device is used, as indicated at the right of Fig. 1. A disc with the same arrangement of holes runs exactly in step with the transmitting disc; but behind the receiving disc is a neon tube, arranged as in ordinary television. The neon tube, however, covers both spirals and illuminates them alternately; so that on the receiving screen appear two images side by side, and separated by approximately half an inch. One of these corresponds to the object as seen by the right

Mr. Baird (right) is here shown demonstrating his "stereovision receiver." The familiar eyepiece with its twin prisms is at the right of the apparatus; the Baird receivers "frame" the image at the side of the scanning disc instead of the top. The microphone in front of this receiver is for communication with the transmitting room.

Photos © Photopress

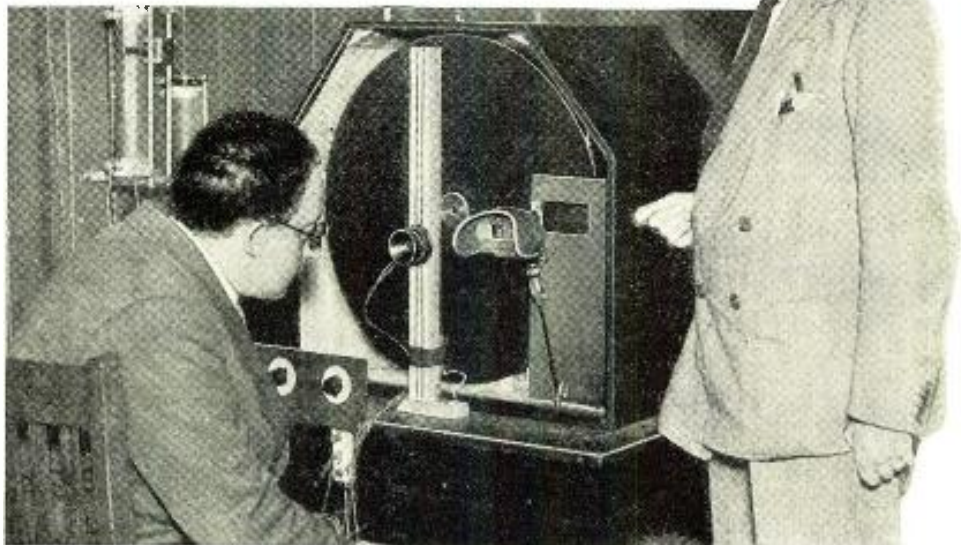

eye, the other to the object as seen by the left eye. These images are then viewed through a stereoscopic viewing device, consisting of two prisms, which cause the images to converge and blend into one, just as in the ordinary stereoscope for photograph viewing.

It may be of interest to note that this stereoscopic viewing device is really unnecessary, and those who have the knack can make the images blend without the use of prisms; merely by looking fixedly at the images, and concentrating, by an act of will, the left eye upon the image at the left and the right eye upon the other. This is, in fact, the method used by most experts in stereoscopy. They seldom use the stereo-

scope, but rely upon the naked eye; in much the same way as a user of the microscope keeps both eyes open, but still sees only the object under the microscope. The eye which is not looking through the microscope is sub-consciously rendered, as it were, blind.

Professor Cheshire, lately president of the British Optical Society, who was present at these demonstrations, stated that a man sitting at the transmitter was very clearly seen on the receiver in another laboratory in the same building, in perfect relief, showing the facial delineation and expression; and declared also that these experiments promise considerable development and importance in their practical application.

## Televentures, Telewitticisms and the Televocabulary

WITH the first public demonstration of successful television, on however modest a scale, the press has taken up the task, in a spirit of humor blended with seriousness, of accustoming itself and its public to the new conditions which must be met. As with the telegraph, the telephone, the electric light, the moving picture, the airplane and the radio broadcast system, all of which have successively emerged from the laboratory in an unperfected condition, to develop into public utilities of the most commonplace nature, so it is to be with television.

A certain amount of gibing at the present unperfected nature of the invention alternates with half-serious prophecy of what it will be when it has reached its fullest growth; in many cases, no doubt, the reality will outrun the joke.

"Moving pictures by radio," remarks H. I. Phillips in "The Sun Dial" of the *New York Sun*, "are soon to be a household commodity. The time may come when every radio set will carry a chart giving Charlie Chaplin's wavelength, the number of kilocycles it takes to get Tom Mix and the right type

of bulb to use to give perfect reception to Douglas Fairbanks."

"Probable complaint to radio service station: 'This set you sent me is no good. I can't get Famous Players or Metro-Goldwyn.'"

"The owner of a two-bulb set soon will be able to get everything a picture house can offer except the ultra-polite ushers, the lobby statuary and the liar outside the box office who tells you there are 'plenty of good seats inside.'"

"The radio is making it more and more unnecessary to leave home for diversion. All that is needed now is announcement from some genius that he has found a way for the family to make its week-end automobile trip by radio and for all men to go to work by television."

#### THE INVENTOR'S CHANCE

More conservatively and sedately, as ever its editorial wont, the *New York Times* looks at the present experimental stage of the art:

"Probably the tinkering televisionary will never be as ubiquitous as was the 'listener-

in' in the heyday of home-set building. The construction of a television apparatus in the garret demands an equipment and a skill beyond the average amateur. At best the 'televised' images must be coarse and barely recognizable, with an almost uncontrollable tendency to shift from the screen. It must not be forgotten that the brilliant demonstrations by the American Telephone and Telegraph Company were possible only with the aid of a score of trained engineers who knew their technical roles as well as the actors of a theatrical company know their lines. 'Fading,' one of the hughars of radio, causes unpleasant distortion of the image, and so does poor synchronization of the transmitting and receiving apparatus. Radiation of faces on a lavish scale is at present a technical impossibility because each television transmitter requires an excessively wide channel in an ether already overcrowded.

"Clearly, the development of television belongs to the engineer. British and German authorities view his task with misgivings and even doubt if it will be possible  
(Continued on page 466)

# The Jenkins "Radio-Movie" Reception Methods



Some Operating Hints Which Will Be Valuable to Television Experimenters in Constructing Their Receiving Apparatus



REGULAR schedules of radio movies have been established by the Jenkins Laboratories, 1519 Connecticut Avenue, Washington, on 46.72 meters (6,420 kilocycles) with 48-line pictures. They run from 8:00 to 9:00 p. m., E. S. T., on Monday, Wednesday and Friday nights (or 0100 to 0200 GMT on Tuesday, Thursday and Saturday mornings). When a sufficient number of amateurs have shown that they are in position to receive these, the broadcasts will be made nightly. Preliminary announcements are made from the station, whose call is 3XK, in both code and phone. At the end of each picture the letters END are shown, to indicate that it is time to return to reception by ear.

The transmitting system, which was described in RADIO NEWS for August ("Radio Movies and Television for the home," page 116) operates to send silhouette images, which are printed on standard moving-picture film. Scanning these with a very small beam of intense light gives an impulse much sharper than that obtained in televising faces, clothing, etc., by reflected light. The images are sent out at the rate of 15 a second, or 900 per minute.

While the Jenkins laboratory-model receiver, described in the article above mentioned, is of very high-grade workmanship, and too complicated for home construction, the television experimenter will find it possible to receive the radio movies on a 48-hole disc running at 900 revolutions per minute.

Later, it is promised, "halftone" or shaded motion pictures will be sent, when it is to be expected that the technique of the receiving amateurs has improved. For the present, a gradual progression in the complexity of the images is being attempted; the earliest film transmitted was only that of a dancing figure, comparable with the "zoetrope" toys, which were the forerunner of the moving picture. Elaborate subjects and later actual stories followed. The broadcasting has been in charge of Stuart Jenks and Paul Tomisen.

"We have discovered," says Mr. Jenkins' announcement, "that stories in silhouette are as entertaining as movie cartoons in the theater; plus, also, the appeal of the mystery of movies by radio.

### BEGINNING A NEW INDUSTRY

"Picture subjects and picture stories in silhouette are easier for the amateur to pick up at first; and obviously the width of the picture-frequency band is very much less and, therefore, greater latitude is available.

"Our immediate interest in the broadcasting of radio movies is to enable the amateurs of America and Canada to become familiar with the principles involved, in the belief that they will assist in this development. The American radio amateur has shown his remarkable cleverness in the development of 'worthless frequencies' below the 200-meter band, as is now generally and officially ac-

knowledged. I expect as great a surprise when the amateur takes up this new work.

"This is the beginning of a new industry—a new form of radio entertainment. With these motion-picture broadcasts we are hoping to contribute to its rapid development. Your reports on our signal strength, fading, echo images and quality of picture reception will greatly help.

"Ultimately, this pantomime story-teller will come to all our firesides as a fascinating teacher and entertainer, without language, literacy or age limitation; a visitor to the homestead with photoplays, the opera, and a direct vision of world activities, without the hindrance of muddy roads, or snow blockades."

While the radio movies are vision only at second-hand, in contrast to the true television, the mechanism reproducing them is the same as that required for television; and it is quite possible that they will find places in television schedules even after the perfection of television, even more so than mechanically-reproduced music does in the radio broadcast schedules of the world today. For instance, many events of great interest in the world take place at hours when the inhabitants of distant lands are busy or sleeping; and their repetition by the radio movies a few hours later, with or without an accompanying sound broadcast, will be a desirable news service.

(Continued on page 492)

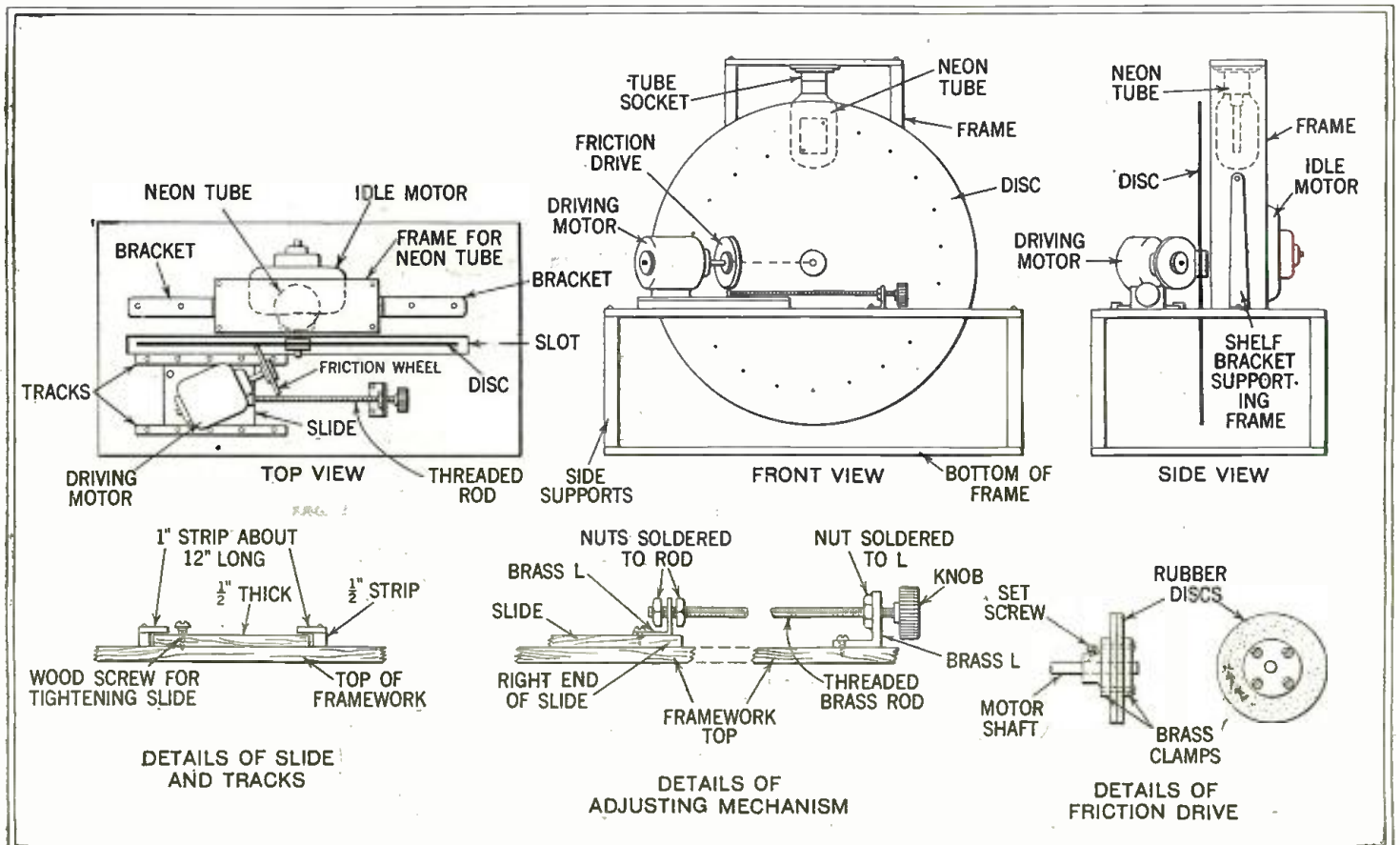

The three upper drawings show the arrangement of the parts of an excellent television or "radio-movie" receiver; the support for the disc may be an idle motor or a small polishing head. Mount the neon tube so that it is not affected by the vibration of the driving motor. In assembling the adjusting mechanism, drill out the upright arms of the L-shaped brackets so that the threaded brass rod will revolve in them easily. Once the proper position for the slide has been found, turn in the wood-screw, so that the motor will not "walk."

# Successful DX Work Marks "Radio-Movie" Transmissions

**R**ADIO experimenters who are contemplating the construction of television or "radio-movie" receivers will be interested to learn of the splendid reception that is being obtained by others who have already assembled the scanning machinery and its supplementary apparatus. Such successful reception should encourage hesitant constructors to proceed with their own receivers without delay, so that they also will experience the great thrill of "seeing by radio."

One of the most active television enthusiasts in the East is James Millen, of Malden, Mass. Although Mr. Millen is a professional radio engineer in the employ of a large manufacturing concern, he is an amateur dabbler at heart and spends a great deal of time in his own home laboratory, pictures of which are shown on this page. He constructed a simple television receiver using a twenty-four-inch disc, a neon-gas glow-lamp and an adjustable-speed motor, and has had unusually good luck in receiving the Jenkins "radio movies" on 46.7 meters.

A letter received from him lately by **RADIO NEWS** reads as follows:

### FIVE-HUNDRED-MILE RECEPTION

"You will, no doubt be interested to know that for the past week I have been able to receive all of the Jenkins 46.7-meter broadcasts on a rather simple outfit built up at home in one evening. While the pictures are not as good as those Jenkins himself demonstrated in Washington, I think they are very fine when one considers the distance involved—somewhere around 500 miles. During a local thunderstorm last Friday (*This letter*



Mr. James Millen

*was written at the end of August.—Editor*), when reception on the broadcast band was almost impossible, we received the entire silhouette broadcast, and had no difficulty in following the movements of the girl bouncing the ball and seeing the ball itself bounce up and down.

"The outfit comprises the standard National short-wave kit, a three-stage transformer-coupled amplifier operated from a 'B' socket-power unit, and the scanning device. The amplifier used was from a broadcast set, with one 'haywire' stage ahead. I

had no trouble in using a 'B' supply unit for both the glow-lamp and the receiving tubes on this short wave."

### THE RECEIVING APPARATUS

That Mr. Millen finds it possible to use a transformer-coupled amplifier for satisfactory reception of images is rather surprising, as practically all television engineers have considered resistance coupling to be necessary, because of its comparatively smoother amplifying characteristics. Mr. Millen's transformers are exceptionally large and heavy ones, which may account for his success with them.

A picture of the amplifier is shown below; it comprises two straight amplifier stages and one of push-pull. Resistance-coupled audio amplifiers will, in most cases, give more reliable images. However, the experimenter owning a high-grade transformer amplifier should by all means try his available apparatus first, before spending money on additional equipment.

The general layout of the apparatus employed appears below. The clock-like instrument on the right side of the scanning-disc box is a speed indicator; this is a rather expensive device but is, of course, a great help in adjusting the speed of the disc's driving motor properly.

The short-wave receiver used by Mr. Millen was assembled from a commercial kit, but experimenters desiring to build one like it are invited to write for **RADIO NEWS** Free Blueprint No. 62. This blueprint shows the construction of a receiver of practically identical design; this employs a screen-grid tube as an R.F. amplifier, and is a very fine all-round short-wave outfit. Remember, the blueprint is free for the asking.

*At the right: The "breadboard" three-stage transformer-coupled amplifier used by Mr. Millen for his reception of the Jenkins "radio movies." Below: A general view of the television receiver. The short-wave tuner is the apparatus with the small panel, the scanning apparatus is in the box on the right. The clock-like instrument connected to the scanning disc is a speed indicator.*

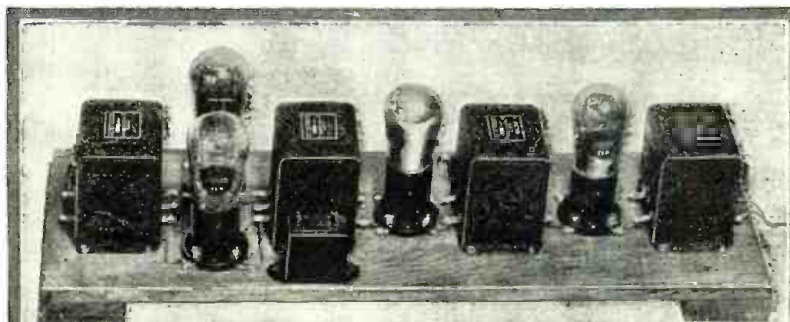

*Below is a rear view of Mr. Millen's scanning apparatus. The neon-gas glow-lamp is mounted upright on the narrow upper shelf behind the scanning disc. The scanning disc's driving motor is an alternating-current machine of the condenser type, designed especially for television work. This receiver is, it will be seen, very much like the one described on page 422 of this issue.*

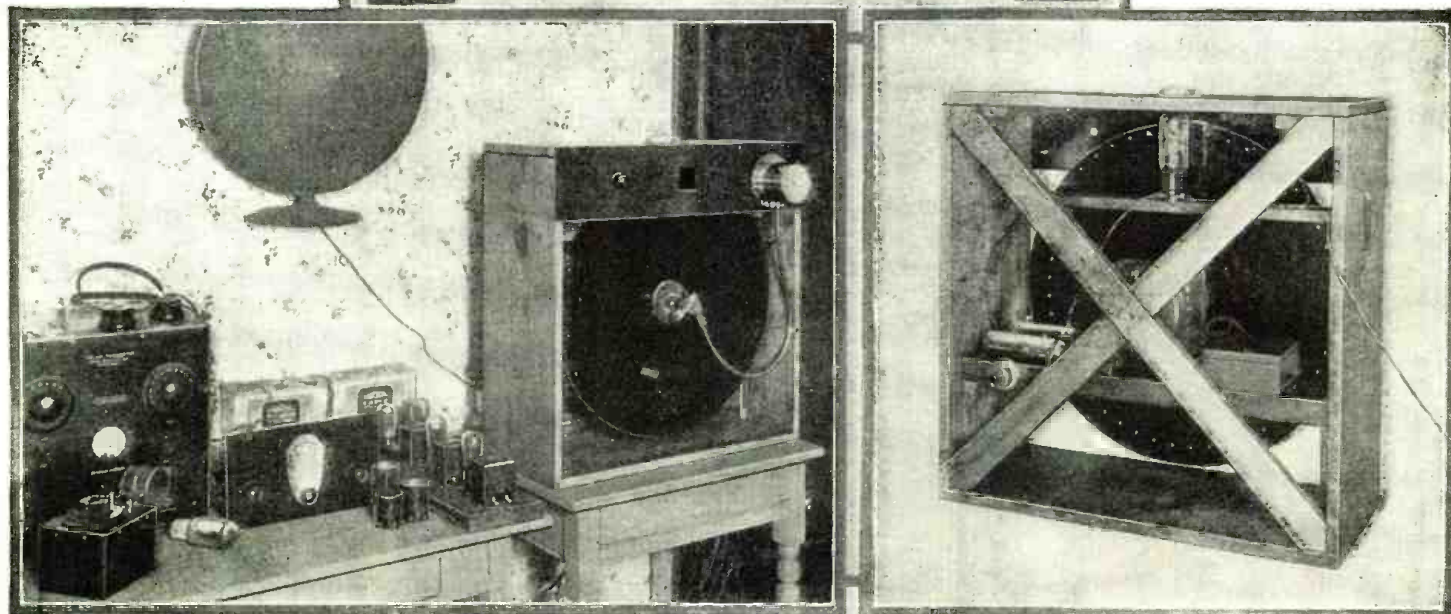

# How to Make Your Own Television Receiver

**I**N order to pick up and reproduce the television images now being broadcast by WRNY and W2XAL, you need only a modest assembly of instruments, some of which you probably already have on hand, and some of which you will have to buy.

First, since the television images are transmitted simultaneously on 326 and 30.91 meters, by WRNY and W2XAL, respectively, you need either a regular broadcast tuner or a short-wave tuner. If you live in or near New York, and obtain satisfactory loud-speaker results from the regular WRNY transmissions, all you require is a separate audio-amplifier of the resistance-coupled type, and the scanning mechanism, to be described later. If you are already using a resistance-coupled amplifier, as many radio fans are, you will need only the scanning apparatus.

If you cannot hear WRNY's 326-meter wave very well, the best thing to do is to install a short-wave set, in order to pick up the 30.91-meter wave of W2XAL. You will require the audio amplifier also, however. Happily, short-wave receivers are very inexpensive and can be built very easily, so you should assemble one without delay. It will enable you to pick up, not only W2XAL's television signals, but also the "radio-movies" of station 3XK (using the Jenkins system), and musical programs from short-wave broadcast stations in many parts of the world. We can particularly recommend the set described in the *RADIO NEWS* Free Blueprint No. 62. This uses an R.F. amplifying stage, has only one tuning control, and costs very little to assemble. If you do not already own a short-wave receiver, just drop us a card and we will send you Blueprint No. 62 free of charge.

In making this receiver, do not install the single stage of audio amplification. Leave out the audio transformer and the third tube, and simply provide two binding posts for the wires that are shown connected to the primary posts of this transformer. The detector is then easily connected to an external resistance-coupled audio amplifier.



H. Gernsback, Editor of *RADIO NEWS*, receiving the television broadcasts from WRNY at his home in New York City, with the simple apparatus described in this article. For purposes of the test, the neon tube and loud speaker were connected in series temporarily, with successful operation simultaneously.

If you are able to use your regular broadcast receiver for WRNY, you will not use for television reception the present audio amplifier if it is of the transformer type. Simply run a wire from the plate (P) post of the detector tube to the top input post of the resistance-coupled amplifier shown in Figs. 1 and 3, unhook the "B+Det" wire running to the power unit or "B" batteries, and bring this same wire to the other input post of the audio amplifier instead. With this arrangement, the detector will be feeding directly into the resistance-coupled amplifier.

#### RANGE OF FREQUENCIES

"Why can't a regular transformer amplifier be used? Why is a resistance amplifier necessary?" you may ask.

The answer is that resistance-coupled amplifiers amplify audio-frequency impulses ranging from 50 to 5,000 cycles *more uniformly* than do most transformer-coupled amplifiers. The television impulses broadcast by WRNY-W2XAL and others cover this frequency range, and they must be reproduced faith-

fully reproduced, these are not very noticeable to the ear. When television images are being reproduced, even the slightest irregularity will cause the already crude images to break up and assume peculiar shapes. The general experience of television experimenters has been that resistance-coupled amplifiers are more satisfactory for both television transmitters and receivers, at least in this stage of the art.

The above statements should not be interpreted as a condemnation of the transformer amplifier. There has long been raging in technical circles a controversy over the respective merits of the transformer and resistance systems for the amplification of voice and musical signals, with the radio experts evenly divided between the two camps. At the present time, however, it is easier to get good pictures from the latter system, so we recommend resistance coupling. However, it is entirely possible to obtain satisfactory results from a *high-quality* transformer arrangement; witness the work being done by James Millen, of Malden, Mass., whose experiments are described briefly on page 421 of this issue.

A good three-stage resistance-coupled amplifier can easily be assembled on a wooden board, about five inches wide and twelve inches long. A completely-assembled one can be bought for about ten dollars, but a home-made one will not cost so much. After you finish it, you will have a fine amplifier, not only for television impulses, but for regular broadcast programs as well.

#### DESIGN OF AN AMPLIFIER

You will need the following parts, arranged and connected as shown in Figs. 1 and 3: a wooden baseboard; three UX-type tube sockets, V1, V2, V3; three 1/4-ampere filament ballast resistors, R4; two double-resistor mountings; four 0.5-mf. fixed condensers of the by-pass type, C; one 1.0-mf. condenser, C1; a special high-value grid

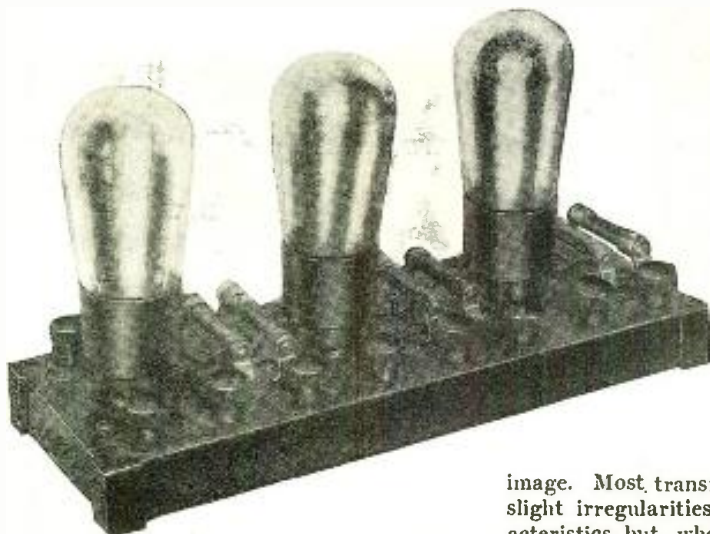

A commercial three-stage amplifier which may be purchased already assembled is convenient and compact. The 171-type tube in the output is best suited to the characteristics of the neon tube.

fully at the receiving end, without emphasis on any particular register, in order to create a recognizable image. Most transformer amplifiers possess slight irregularities in their response characteristics but, when voice or music is be-



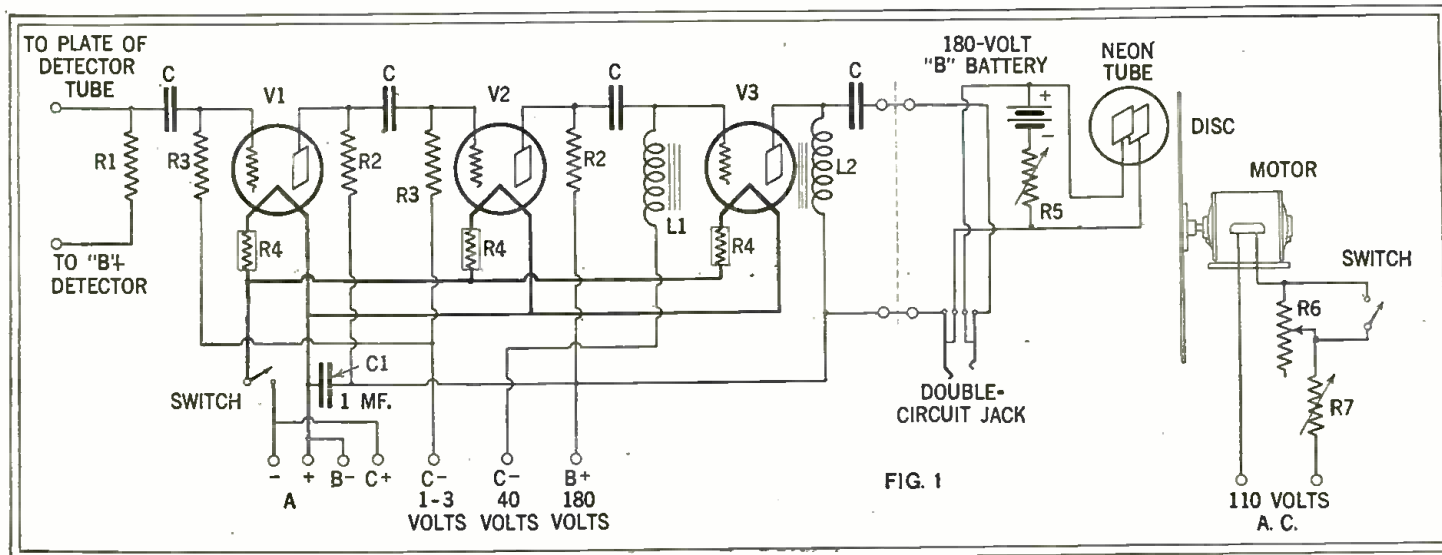

FIG. 1

With this arrangement, sufficient amplification for good signals is obtained by the use of two "high-mu" tubes and a 171-type in the last stage. When the speaker is plugged into the jack, the neon lamp tube is disconnected automatically from the amplifier.

impedance, L1; an output choke of 30 henries, L2; a filament switch; eleven binding posts; fixed resistors of the following values: one 100,000-ohm, R1; four 250,000-ohm, R2 and R3.

The grid impedance unit I.1 is used instead of a grid leak in the last stage, as

page 427); so nothing more need be said about it here.

The scanning disc is merely a flat disc of aluminum drilled with a spiral of holes about 3/64-inch in diameter, as shown in Fig. 4. Now please accept a word of kind advice: don't try to make your own scanning disc unless you have available a lathe and a power drill-press, and have had some years of experience as a mechanic on precision work. We are showing the details of the disc as a matter of interest, and not with the expectation of having our readers make it themselves. Buy a disc—there are a number of inexpensive ones now on the market—and you can then expect to see good images.

For a motor to turn the disc, you can get either a condenser-type machine designed especially for television work, or a universal motor such as are used by the thousands for electric fans, vacuum cleaners, coffee grinders, etc. The speed of the motor must be capable of adjustment by an external rheostat; for it must be slowed down to 450 revolutions per minute for WRNY-W2XAL, or 900 for the Jenkins radio-movies from

directly behind the disc and above the motor, with its flat plates parallel and as close as possible to the back surface of the disc. The tube should be placed along the vertical center line of the disc, at such a height that the outermost hole of the spiral sweeps just under the top edge of the plates, and the innermost hole just above the bottom edge. Any strong, rigid framework that satisfies these conditions will serve the purpose.

The drawings (Figs. 5 and 6) show an arrangement of excellent design. A simple box 31 inches square and 12 inches deep is made up of 3/4-inch boards, securely fastened together with wood-screws. The corners are strengthened by additional 3/4-inch strips about 1 1/2 inches wide. A shelf to hold the motor is made of another piece of 3/4-inch stock about eight inches wide, and supported by two side and one center supports. No dimensions are given for the latter pieces because they naturally will depend on the size of the particular motor on hand. They should be cut so that the center of the scanning disc coincides with the center point of the box.

The neon tube is suspended upside down from the top of the box; its socket can be spaced away from the board with thin strips in order to lower the tube to the proper position with relation to the holes in the disc.

The back of the box may be covered, or left open. A piece of beaver board, or



The cabinet of the reproducer with the front removed, showing the lamp and the motor with its regulating condenser. The "B" blocks are conveniently located beneath.

shown in Fig. 1. In this position it overcomes the tendency of the amplifier to "motorboat" when used with a "B" socket-power device. The tubes V1 and V2 are of the 240 ("high-mu") type, while V3 is a 171A.

The wiring of the amplifier is simple, and should give no trouble. The hook-up is that of a perfectly straightforward resistance-coupled system, with an output filter consisting of a choke coil (L2) and a fixed condenser (the last of those marked C).

**BUILDING THE TELEVISOR**

With the amplifier finished, the next step is construction of the scanning mechanism. For this you will need the following parts: a neon-gas glow-lamp, which fits in a standard UX-type socket; a scanning disc 2 1/2 inches in diameter, drilled with a spiral of 48 round or square holes; a universal or a condenser-type motor, of not over 1/8-horsepower; a variable resistor, 0-10,000 ohms, R5; a rheostat, 100 ohms, R7; a rheostat, 0-10 ohms, R6, and a pear-shaped hand switch.

The neon-gas glow-lamp is described in detail in another article in this number (see



The scanning disc, to show the image in correct arrangement, must revolve in the direction opposite to those of the hands of a clock.

3XK. A synchronous motor, revolving at 1,800 r.p.m., can be used only if it is geared to the disc by 1:1 or 1:2 reduction gears, for WRNY and 3XK, respectively. The 1/8-horsepower size of motor is widely available, and is just right. A special condenser-type motor was used in the particular television receiver shown in the accompanying illustrations, and proved exceedingly satisfactory because its speed can be controlled very smoothly by a hand rheostat. This motor has a half-inch shaft, on which the mounting flange of the disc fitted snugly. If you happen to pick up a motor with a shaft smaller than 1/2-inch, you can buy for a few cents a bushing to adapt the disc to it.

**THE TELEVISOR BOX**

The idea is now to assemble the scanning apparatus so that the neon tube is mounted

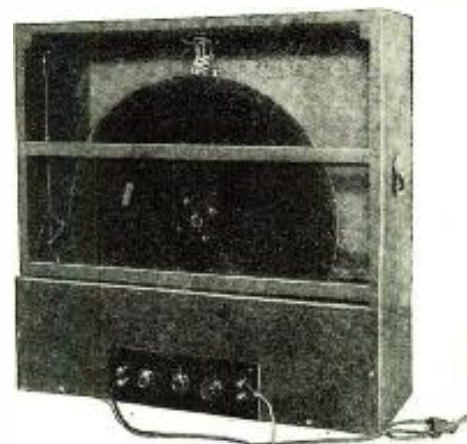

The lower panel of the cabinet—which was solidly built—in place showing the controls, (R 5, 6, 7), switch, and lead from the amplifier.

similar 1/4-inch board used for partitions, will be most suitable for the purpose.

The front of the box should be covered with two pieces of this board, one 21 inches high and the other 10 inches. From the larger piece cut out a hole 1 5/8 inches square, directly in front of the square plates of the neon tube. On the small board mount the three variable resistors R5, R6 and R7, and two pairs of binding posts, as shown in Fig. 6. A telephone jack may also be mounted on this panel; this device is optional and its uses will be discussed later.

To facilitate experimentation with the disc, motor and the neon tube, do not permanently screw down these front panels at first; but merely turn one or two screws into each, to hold them in position.

It is well worth while to construct a box like this, as it will afford absolute protection against the rotating disc. The latter is far less dangerous than any ordinary 'B' power device but, as a matter of safety, revolving machinery of any kind should be enclosed. If you do not want to make anything as elaborate as this heavy box, use lighter material for the sides, or make upright supports of broomsticks and cover the sides with cloth. At any event, be sure that the motor is securely fastened, and that the neon tube is not shaken by its vibration.

**CONNECTING THE TELEVISOR**

With all the mechanical work done, you can now start with the electrical end. As explained by many articles in RADIO NEWS, the neon-gas glow-lamp has the same function in a television receiver that the loud speaker has in a music receiver. It translates back into light-impulses the modulated electrical impulses created at the transmitter by the photoelectric cells. (See the first article in this issue for a fuller explanation.) It is connected in exactly the same place in the audio circuit that the loud speaker ordinarily occupies.

The best arrangement is shown in Fig. 1. The two output posts of the resistance-coupled amplifier are led to a double-circuit telephone jack, which may be mounted on

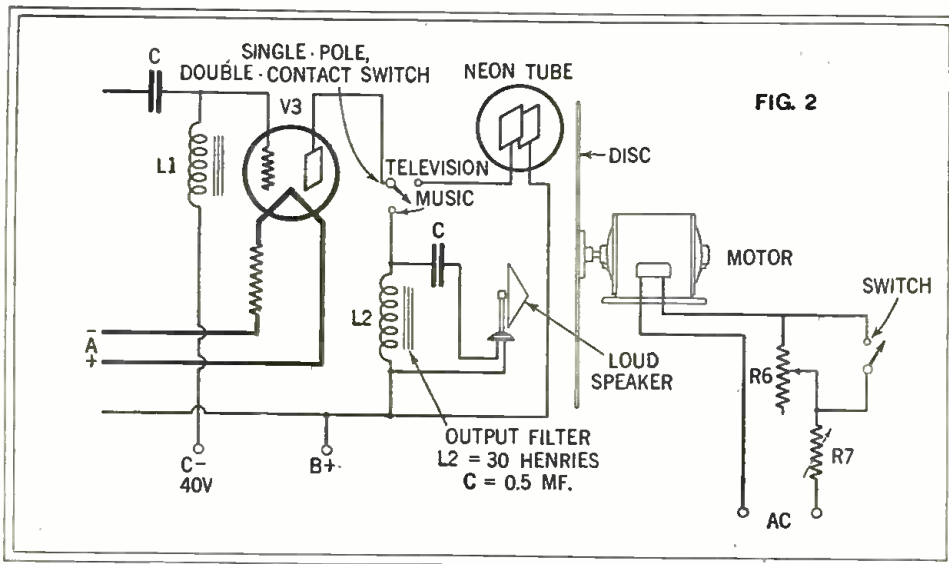

An alternate arrangement for the output of the amplifier shown in Fig. 1.

the lower panel of the box holding the scanning apparatus. The inner springs run to the connection posts of the neon tube, across which are connected also the resistor R5 and a separate 180-volt "B" battery. Resistors R6 and R7 are in series with each

other in the 110-volt A.C. circuit. A six-foot length of flexible cord is run from the pear switch (which is nothing more than a push button in a small wood case which can be held comfortably in the hand) to the resistor R6.

Now turn on your receiver, tune in WRNY or W2XAL with the loud speaker plugged into the double-circuit jack, and adjust the set to give a clear, loud signal. Turn up the resistor R5 until the neon tube breaks out into a bright pink glow. The glow should take place on the plate facing the disc. If it appears on the opposite plate, reverse the battery connections to it. Further details on the characteristics and operation of the glow-lamp will be found in an article on page 427 of this issue.

Turn on the alternating current to the motor, and adjust R7 so that the latter turns at about half its normal speed. Turn off all the lights in the room. The instant the buzz-saw note of the television signals comes through the loud speaker, pull out

**No. 67**

Large blueprints of the diagrams in this article, containing information for the construction of a television amplifier and reproducer as illustrated here, will be sent postpaid on request. Write to the Blueprint Department on a sheet of paper separate from any letter to other departments; print your name and address legibly and ask for No. 67. (See also page 449.) This will avoid possible delay.

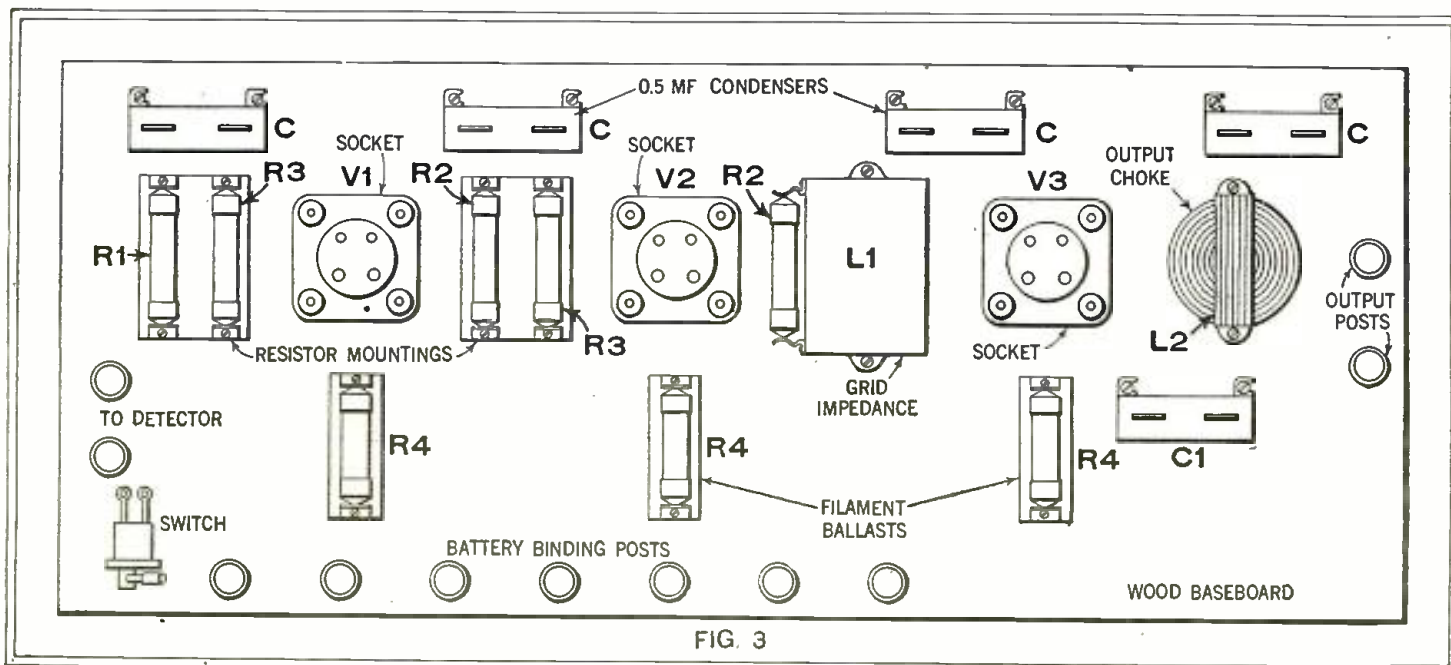

A simple layout for an amplifier such as that shown in Fig. 1. It uses straight resistance coupling in the first two stages (see preceding pages for values), a grid impedance coil, and an output

choke. The output may be connected as in Fig. 2, above, for greater convenience. It is possible, also, to have the tube and speaker in series, with a slight additional "B+" voltage.

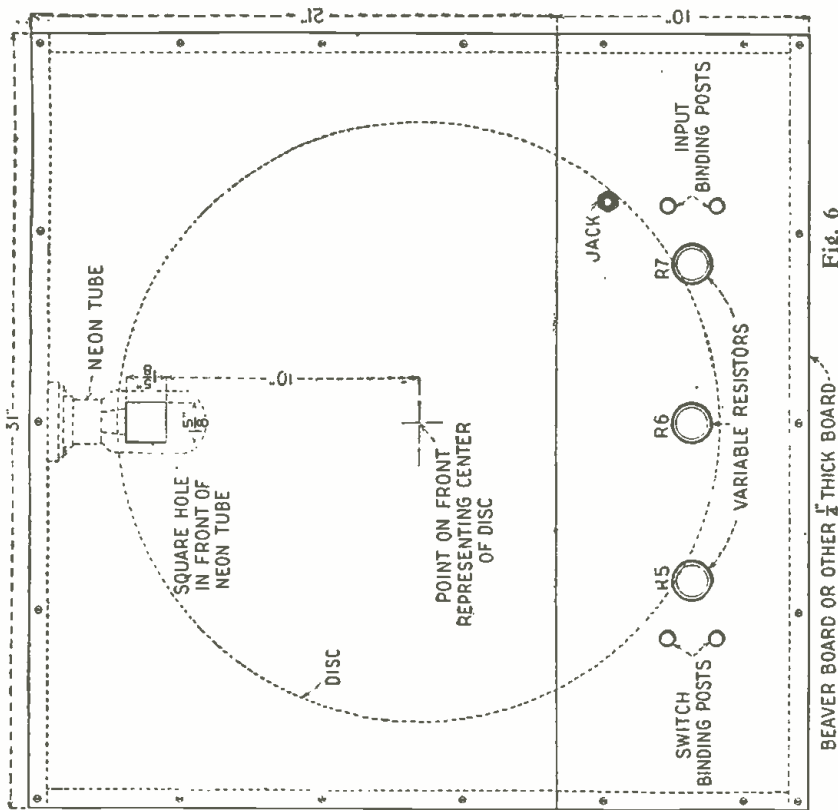

Here we have the front of the box. While the cabinet illustrated is fitted with heavy wooden panels, beaver board or similar material is quite heavy enough for the purpose. The controls are conveniently mounted, as shown.

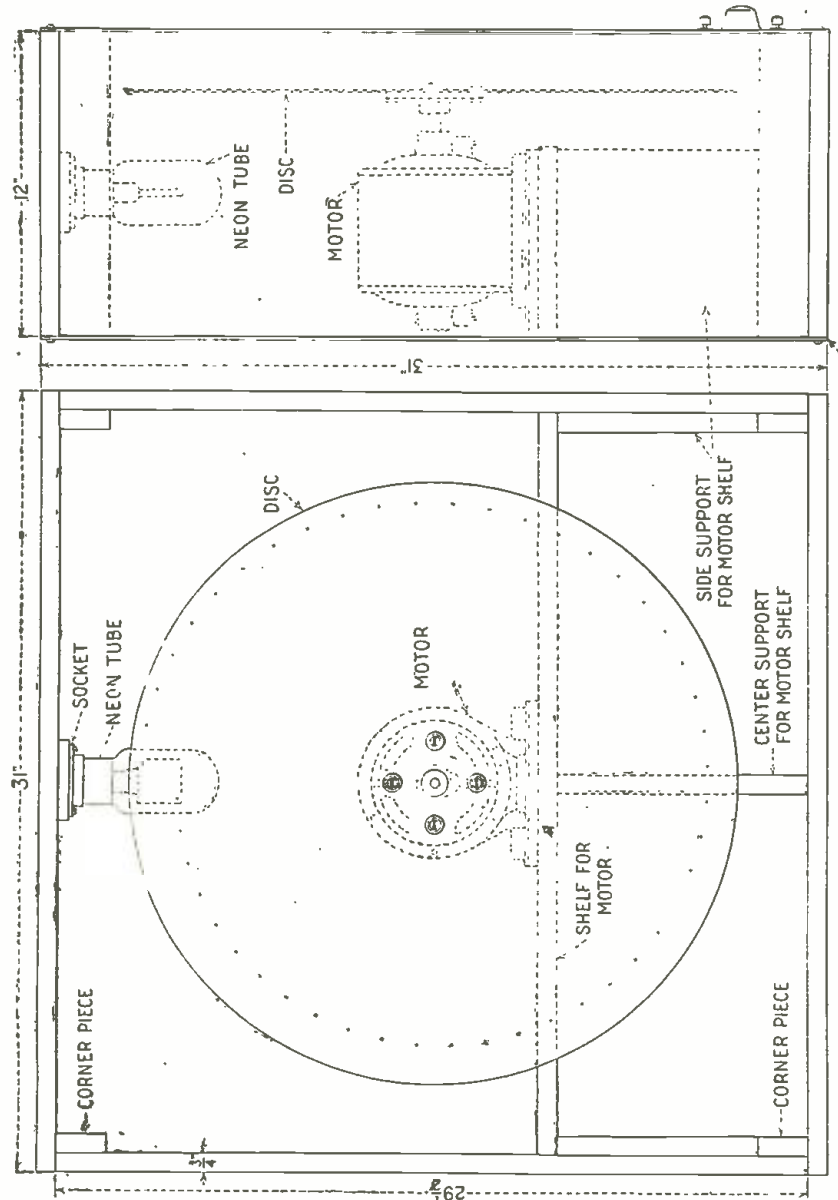

The height of the shelf is governed by the distance from the center of the motor's shaft to its base. After the latter has been mounted, the neon tube is easily adjusted to the proper place to cover the inner and outer holes of the disc with its plate. Sponge-rubber mounting may be useful to protect it from vibrations through the cabinet.

the speaker plug and start playing with the motor rheostat, R7.

OPERATING IS SIMPLE

If you have no tachometer (speed indicator), the only thing to do is to run the motor up and down the scale. When you hit 450 r.p.m., the crazy criss-cross lines that are shooting back and forth and up and down the surface of the disc in front of the neon tube should melt into a rough image of a man's face, or other distinguishable object. You will notice that, with no signal being fed to the neon tube, the square of pinkish light you observe through the disc is streaked with fine dark lines. The instant the audio signal is turned on, this even glow will be modulated by the fluctuating currents. When you hit 450 r.p.m. and the image of the man's face literally uncurls itself from the hodge-podge you saw before, you will experience a thrill that will make all the effort well worth while. You probably received a big "kick" from your first successful broadcast receiver but, when you see your first television image, you will know what a real thrill is.

In the absence of any synchronizing system, the images will tend to wander out of view but, by carefully manipulating the control rheostat R7, you can find the proper setting for 450 r.p.m. The use of the smaller rheostat R6, with its switch, is more or less incidental. Set R6 to about half its value, and just press the switch for an instant when the images start to run off. This will cause the motor to jerk and speed up for a second.

If you are using a universal motor, you can disregard R6 and its switch altogether and depend on R7 for the speed control.

The images you receive may be upside down, or the WRNY televised card may read backward. To correct these conditions, follow the operating hints given in the article on pages 428-9.

OTHER ARRANGEMENTS

An alternate circuit arrangement is shown in Fig. 2. Here the neon tube is connected directly in series with the plate circuit of the last audio tube, with a single-pole, double-contact switch to shift the output of the tube. The rest of the amplifier and motor circuit is exactly like that of Fig. 1. This is a simple hook-up; but its main disadvantage is that the voltage applied to the "B+" post must be at least 300 volts, as there is a drop of about 150 volts across the neon tube itself, and V3 is a 171A, which operates on 180 volts. As no "B" power unit designed for 171 operation will supply more than about 220 or 250 volts, it will be necessary to connect one or two 45-volt "B" battery blocks in series with the highest voltage lead from the unit you have. At least, this will be cheaper than using four 45-volt blocks for the hook-up of Fig. 1.

Several experimenters have used a "B" power unit for the neon-tube illumination with good success, but separate batteries are really the cheapest, easiest and most satisfactory source of supply.

The audio amplifier need not be limited to a 171A for the output stage. A 210-type power amplifier will work perfectly well, but in this case the shunt-feed scheme of Fig. 1 should be used. The series arrangement of Fig. 2 will strain the power pack and the neon tube is likely to be burned up by the high plate current. With the Fig. 2

(Continued on page 466)

# Synchronized Broadcast Joins Images and Music

Wire Transmission of Image-Frequencies and Radio Reception of Sound Enable Audience to See as Well as Hear Miniature Drama

**A** FORETASTE of the radio television of the future, accompanied as it will be by radio "teleaudition," was given to radio fans in Newark, N. J., during the week of August 19, when a demonstration of "wired television" synchronized with musical radio reception was presented at the huge department store of L. Bamberger & Co., owners of station WOR. On its sixth floor the transmitter and receiver, linked together by short wire lines, had been installed by their manufacturer, the Daven Radio Corporation of the same city; and two-hour marionette performances were daily enacted before the transmitter and reproduced before the eyes of the radio spectators in synchronism with the music broadcast at the same time from WOR. The little dance of the puppets was repeated each two minutes during the period of the demonstration; as the limitations of the lamp and screen used in the receiver, as in other present-moment television apparatus, prevent the image from being seen by many at once.

"It is our belief," said a representative of WOR, explaining the reason for holding the demonstration at this time—that of giving the public a basis on which to found an idea of the coming importance of television in radio programs of the comparatively near future—that television broadcasts will

eventually be combined with the simultaneous transmission of speech and music; but this is impracticable at the present moment, from the viewpoint of both transmission and reception. However, by the use of a wire line, we are able to present the effect of synchronized reception of a radio program consisting of simultaneous music and television."

## THE SYSTEM EMPLOYED

The "wired-television" apparatus employed is similar in principle, of course, to other installations recently demonstrated over radio channels, both short and long-wave. The transmitter comprises a 48-hole scanning disc, 24 inches in diameter and rotated at 1,000 revolutions per minute by its motor, and four 7-inch photoelectric cells. A 900-watt tungsten lamp produces the light beam which the scanning disc causes to "explore" the field of its subjects a trifle over sixteen times a second. A condensing lens aids in this task of illuminating the miniature stage. The light reflected, spot by spot, from the surfaces covered by the dancing beam emitted by the lamp is converted into electrical pulses by the photoelectric cells; and these signals are passed through a six-stage resistance-coupled amplifier of special design to handle the combination of audible and supersonic fre-

quencies which makes up the television band

The arrangement of the apparatus appears in the illustration; the scanning disc may be seen directly in front of the demonstrating engineer, and the source of illumination is housed in the hood behind the disc. The frame before the disc contains the four photoelectric cells and the first five stages of the amplifier. The final stage of 210-type tubes, in push-pull, is contained in the small box on the table at the right, and the "B" power-supply unit is in the larger box beside it.

## RECEPTION ADJUSTMENTS

Since the range of frequencies required by the television dramas ran far beyond available broadcast channels, the transmitter was connected directly by wire to the receiver on the same floor. The latter apparatus also is standard; it is housed in a wooden cabinet, approximately 30 inches high and wide, and 8 inches deep. The assembly comprises the conventional scanning disc with its motor, and the neon-filled glow-tube. The controls on the front of the housing include a resistor governing the speed of the motor, a switch turning it on or off, a rheostat regulating the direct-current voltage across the plates of the neon tube,

(Continued on page 476)

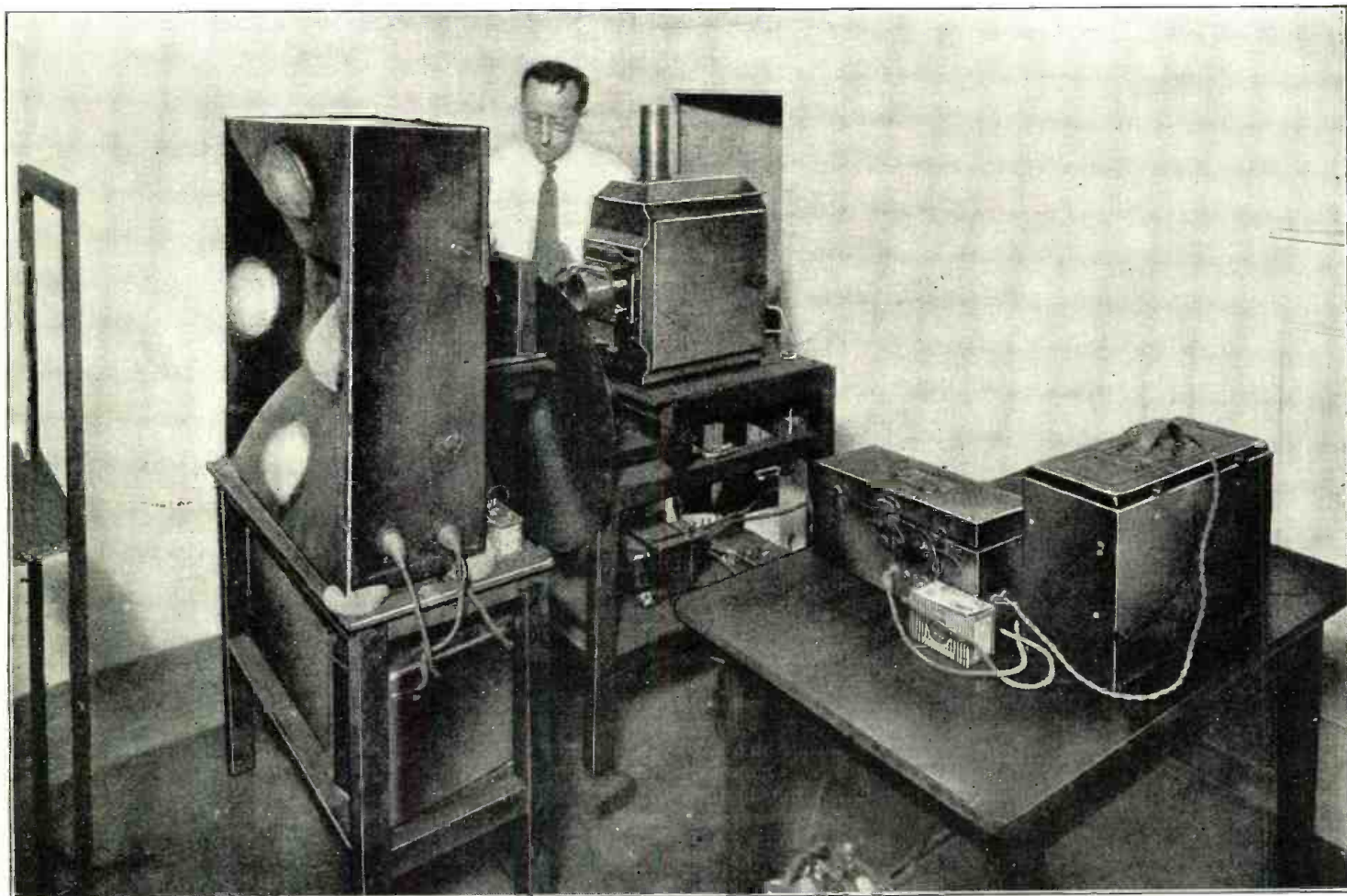

Set up of the television transmitter used at WOR during the synchronized transmission. The puppets' "stage" is at the extreme left; the apparatus is of the usual type.

# The Neon Tube—Television's "Loud Speaker"



How This Marvelous Device Makes Possible the Distant Reproduction of Moving Scenes Simultaneously with Their Occurrence



By D. E. Replogle\*

ONE of the essential components of a television receiver is the glow-lamp; this and its associated scanning device serve the same purpose in the television apparatus that the loud speaker serves in the radio set.

This remarkable device, as most successfully developed, utilizes neon gas as the luminous element, and is the only lamp yet known which, without prohibitive cost, can be made, satisfactorily, to meet the requirements of the present television systems; in which there is required a light-source, of uniform intensity over a large area, which will instantaneously vary in brilliancy with variations in the television signals. The television lamp most strikingly differs from the familiar electric lamp, in that it gives off a soft orange "glow" from a large surface which may be looked at without hurting the eyes, rather than the dazzling white "spot" of an incandescent tungsten filament. The color of this glow may be readily controlled in manufacture by variation in the kind and quantity of gas employed within the bulb.

As will be seen from Fig. 1, the construction of the television lamp is apparently quite simple; although this simplified appearance has been secured only after a great deal of research work with gaseous-conduction tubes and neon lamps of all types and for many different uses. Indeed, the development and refinement of this device has involved a review of many rare gases, a deep study of atomic structure, and a long process of reasoning out the acrobatics of electrons. The highly intricate action taking place in the miniature universe of the gas contained in the television lamp is, therefore, not at all in keeping with the utter simplicity of the mechanism and electrical features of the device; yet we must master the first before we can enjoy the second.

## ITS ACTION A PARADOX

The "glow" takes place uniformly over the surface of either one or the other of the two flat and parallel plates (P and P1, Fig. 1); the effect depending upon which plate is connected to the positive and which to the negative side of the power supply. The two parallel plates are so placed with respect to each other as to utilize the principle of "short-path" insulation in order to prevent "glow" between the plates which, of course, would not be very desirable.

The "short-path" principle is one of those scientific truths that are stranger than fiction. Briefly, in a gaseous conducting medium, if we have oppositely-charged metallic bodies of sufficiently high potential difference, the gas between will "break down" or "ionize," and conduction will take place from one to the other. However, move these same conductors *very close to each other*, and the gas between is no longer ionized; which is apparent from the fact that there is no longer a glow present in the tube. Current ceases to flow from

one to the other. An excellent insulator is now presented by the intervening gas. Why?

The explanation is steeped in academic science, which is usually far beyond the realm of the layman. Furthermore, no one has ever seen atoms or electrons; hence cold logic steps in to explain things which man may never see for himself. However, if we may be permitted to make a free translation into lay language, of a theory by C. G. Smith, inventor of the "S" tube, the story runs about like this:

The facing charges of electricity are bound to produce action. Some loose electron in the gap between the charged conductors is coaxed toward one or the other, and rapidly accelerates its rate of travel until its speed is sufficient to smash those atoms obstructing its path. The collisions result in ionization, or the breaking down of the gas, which then becomes a fair conductor of electricity; or, to put it another way, there is now a wholesale movement of electrons. It is evident, then, that the electron needs a good running start, so to speak, in order to smash things up in general. Failing in a good running start, the electron does no smashing, ionization cannot take place, and there is no electrical conduction; the gas, under such circumstances is a good insulator. Some gases require a longer path for ionization than others, which is another important consideration. Helium is especially ideal in this respect, having an exceptionally long free path.

## CONSTRUCTION OF THE GLOW LAMP

The "short-path" principle, then, is adopted merely to prevent electrons from getting a good running start; it is practically applied in insulating the inner surfaces of the two electrode plates most effectively.

Glass spacers are arranged at the top edge of the plates in order to maintain this

separation at just the right value, while the supporting rods between the stem and the lower edges of the plates serve the same purpose at the bottom. The cross rod at the top of the plates is merely to prevent the plates from being bent away from their normal vertical plane, as a result of jars during transportation. This brace serves also to prevent vibration of the plates when the tube is mounted on the same framework as the scanning-disc motor, as frequently is the case.

The bulb surrounding the two plates is of particularly clear glass, to permit the radiation of the maximum amount of light. The tube contains neon gas, at a low pressure, together with certain alkaline substances which increase the speed of operation and the intensity of illumination.

The tube is fitted with a standard UX base. The luminous plates are placed in a plane at right angles to the axis of the socket pin. In a television receiver, therefore, the pin should point directly either to or away from the scanning disc, in order that the glow-lamp's plates may be parallel to the disc. Connections are made to the plate, and one of the filament, prongs of the socket.

## CIRCUIT CHARACTERISTICS

As with all types of gas-discharge tubes, the neon lamp has a very pronounced "negative-resistance" characteristic and a stabilizing resistor must always be used in series with the lamp and the supply voltages. (This is just a technical way of saying that the internal electrical resistance of the lamp decreases as the current through the lamp is increased. Thus, if no current-limiting resistor were to be used in series with the

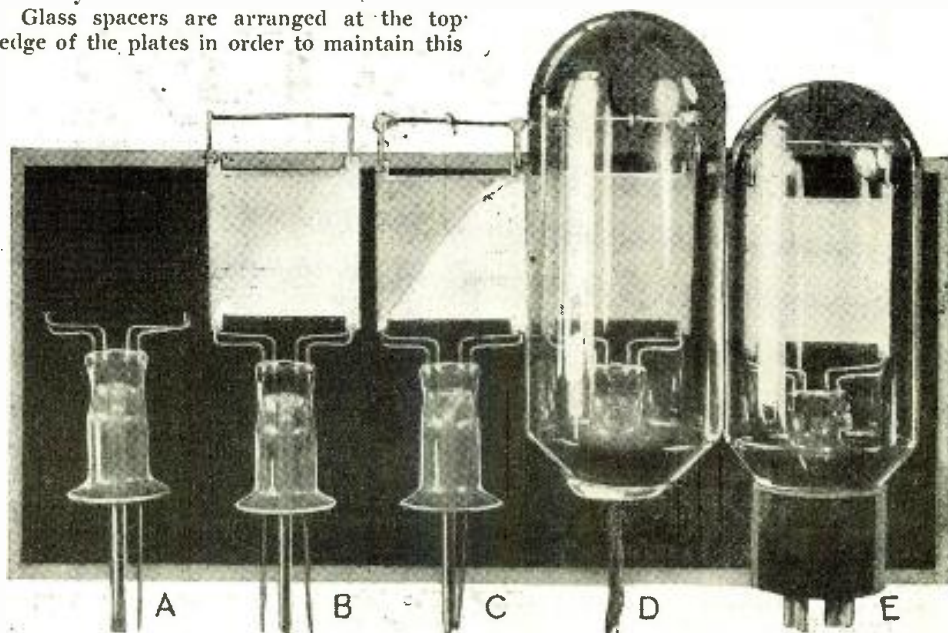

The steps in the assembly of a glow lamp: A, glass stem and wire supports, ready for the plates. B, plates mounted in position. C, plates completely assembled, with top wire supports. D, tube ready for evacuation. E, completed tube ready to work.

\* Raytheon Manufacturing Company

tube, the current would tend continually to increase and, as it increased, the resistance of the tube would automatically decrease, causing still further current increase and so on; until an excessive current value was reached and the lamp destroyed.) A resistor which is smoothly variable through a wide range (0-500,000 ohms) will be found very convenient for this purpose; as not only does it stabilize the tube operation, but it serves also as a ready means for adjusting the current through the lamp, and thus its brilliancy, to the desired value.

As will be seen from Figs. 2 and 3 a D.C. voltage of 180 is required for proper operation. By means of the series variable resistor, the current through the lamp may then be controlled between 5 and 20 milliamperes. With a current of less than 5 milliamperes, the glow on the plates is not uniform and, therefore, not satisfactory for television use. As the current is increased in intensity from 5 to 20 milliamperes, the glow remains very uniform and increases in intensity. Currents in excess of 20 milliamperes should not be passed through the tube or its life will be materially shortened.

As will be seen, either a separate D.C. source (which may be either batteries as in Fig. 3, or a good "B" power unit), or else, in some instances, the plate current of the power tube itself, as in Fig. 2; may be used to light the lamp. In case the regular power-tube plate supply is used, the plate-to-filament resistance of the power tube serves as the stabilizing resistor and the plate voltage must be increased from the normal value (180 volts in case of the UX-171 type) by an amount equal to the drop across the lamp (about 150 volts).

While the impedance of the neon lamp is quite low—500 ohms—it should be operated directly in the output circuit of the power tube (either UX-171 or UX-210) without using any impedance-adjusting device. Such an arrangement is used because the television lamp is a current-operated device rather than a power-operated device; therefore the most desirable output circuit arrangement is one which provides for a maximum of current change in the plate circuit of the power tube in which the lamp is connected.

REVERSING THE COLOR EFFECT

It has already been mentioned that changing the D.C. connections to the tube changes the "glow" from one plate to the other. Interchanging the A.C. connections, on the other hand, reverses the character of the image, in the reception of television. Thus one connection will give a positive picture, and the reverse a negative. That such a condition is possible will readily be seen if we consider the instant at which one A.C. lead is positive and the other negative. If these leads are so connected to the electrode plates that the A.C. "+" lead and the D.C. "+" lead are on one plate, and the A.C. "-" and the D.C. "-" lead on the other, the "instantaneous" current through the tube is equal to the instantaneous A.C. value plus the steady D.C. value and the instantaneous brilliancy of the illumination is greater than normal.

If, on the other hand, however, the A.C. leads have been interchanged with respect to the D.C. leads, the instantaneous value of the alternating current opposes the direct current and, as a result, the brilliancy of

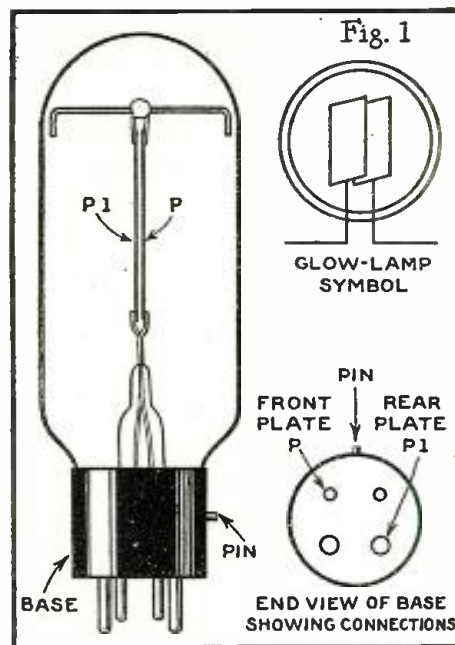

The details here show more clearly the arrangement of the neon tube's elements. The article explains why the glow is on the outside of the plates—not between them, as might be expected.

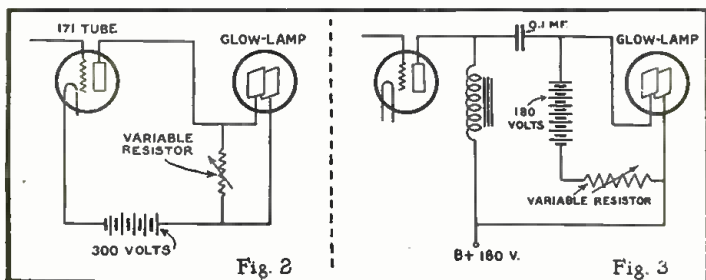

A higher "B+Max" voltage is needed in Fig. 2, where the power tube's plate current lights the neon tube; while in Fig. 3 the additional batteries are across the latter only (See page 423). The value of the coupling condenser is not critical.

illumination will be below, rather than above, normal. See Fig. 4 on the next page.

Thus, in the first instance, a signal impulse results in the illumination of the tube getting dimmer, and in the other brighter; which in turn, results in a positive picture in the first instance, and a negative in the second, providing the polarity of the signal voltage is the same as it was at the transmitting end. In the case of some amplifiers, however, the instantaneous polarity of the signal voltage may be reversed by the time it reaches the television lamp; this is the case with a "grid leak-condenser" detector working into an even number of resistance-coupled audio stages. In such an instance, a reversed or negative image would always be obtained if it were not possible to correct matters simply by reversing the lamp connections.

## How to Adjust the Television Receiver for Operation

THE first step in the reception of a television image is the locating of the signal on the receiver dials. This is best done with the aid of headphones or a loud speaker connected in place of the neon tube. Do not fail, however, to have a fixed condenser of about 1 mf. capacity in series with the phones when connected in place of the neon tube or across its terminals.

The television signal has a distinctive sound but, unfortunately, the short-wave band contains several signals that may easily be mistaken for television. For instance, the high-speed code transmissions of such stations as WIZ and WQO are quite like a television signal because of the "flutter," or what may be called a "group frequency." On the broadcast band, in which WRNY operates, this trouble will not be experienced.

In addition to a low "group frequency," which is the rate at which complete pictures are transmitted and which is around

18 to 20 cycles (per second), the television signal contains high-frequency notes whose character depends upon the nature and the position of the subject before the transmitter pick-up.

The experimenter will hear a signal which sounds at first like a flutter and will then note that this flutter is really the rapid repetition of a high-frequency note. The nature of this note and its loudness constantly change as the subject before the transmitter moves or is changed. For instance, a newspaper rolled up and held in a vertical position produces a distinct note which is very clean cut. A hand does not produce so clear a note, yet the signal is of the same general nature.

"CRAZY" IMAGES

The television experimenter may, upon his first attempts, be puzzled to find his received images either turned upside down, or else reversed as when looking through a photographic negative the wrong way. Both

of these faults can be corrected quite easily.

It is quite obvious when an image is upside down, and the correction of this fault is equally obvious. The subjects before the transmitters at most stations broadcasting television are scanned from top to bottom during one rotation of the disc. Accordingly, if the receiving disc is so rotated that the plate of the neon tube is scanned from the bottom to top, the picture will be inverted. To reverse the manner in which the neon lamp plate is scanned vertically, it is necessary either to reverse the rotation of the disc or to remove the disc from the driving motor and turn it around. The latter operation may involve the removal of the hub and remounting on the opposite side of the disc.

Whether or not the received image is reversed horizontally, is impossible to tell unless one happens to know the scene being transmitted, or unless distinctive characters are held before the transmitter pick-up. For example, one of the objects often

placed before the transmitter pick-up at station WLEX, in Boston, is a microphone stand with the station letters mounted on it. If the image of the microphone stand and letters is received with the object erect but reversed (so that the letters read "XELW") then the scanning disc is being so rotated that the holes pass the glowing plate of the neon tube in the wrong direction.

The correction of this fault is not so obvious. It is plain that whether the experimenter scans the plate from top to bottom or from bottom to top, makes the difference between the picture being right-side up or upside down. Similarly, whether the experimenter scans the plate from left to right or from right to left makes the difference between seeing the image correctly or reversed.

How can we make the holes pass the plate in the opposite direction and still progress from top to bottom? Reversing the rotation of the disc alone will turn the image upside down. The disc must also be turned around on the shaft of the motor. Thus if the image is right-side up but reversed, we must reverse the direction of rotation of the disc, and also remove the disc from the shaft and turn it around with the other side out.

In spite of the fact that these two factors make three wrong combinations and only one correct one, the wrong combinations provide perfectly recognizable images whose worse fault is to be upside down.

Should the image obtained be a *negative* instead of a positive, the trouble is due to reversed A.C. connections to the neon tube. Interchanging these connections will correct the trouble.

In the experimental work at WLEX it has been found that the television signal may be almost submerged in noise and yet provide an image. This fact will undoubtedly be of interest to those who are already trying to receive the signals from WGY and WRNY and who think that reception is

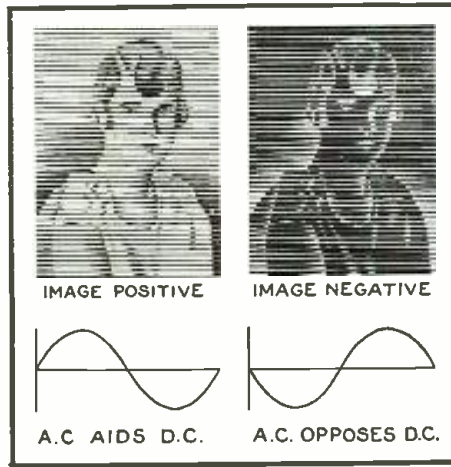

Fig. 4

When the image is negative, as shown at the right, the A.C. signal is working against the battery. Reversing the leads to the lamp is the simplest remedy.

hopeless, because of the noise caused by daytime electrical disturbances and the static of warm weather.

It is true that, when we are interested in listening to a signal, the noise level is an important determining factor; but in the case of television, the noise level may be high—in fact, so high as to make speech

transmission hopeless—and still a fair image can be received. Of course, noise does not help matters; it produces a mottled background and tends to speckle the picture itself. Extreme noise will produce dark lines of varying width across the field of the image. But in spite of this, the picture is there and, since noise is *non-periodic unless introduced by vibration from the motor and disc*, the speckle and dark lines are continually shifting their positions while the image remains generally stationary or moves in an orderly fashion.

Therefore, if in the experimenter's attempts to receive television images, he finds the signal more or less accompanied by noise, he should not judge the noise by speech broadcast standards, but go right ahead and try the signal on the disc. It goes without saying that the minimum of noise should be introduced by the set itself. Loose connections in the microphonic tubes, noisy resistors, and other causes of noises should be avoided.

When a good television signal is being received, it sounds quite like a slowly-revolving circular saw which is slightly off center. In other words, one hears a high-pitched note which might correspond to the tooth frequency, and broken up into groups whose frequency corresponds to the rate at which the saw (the disk) rotates. The latter we have referred to as the group frequency while the high-pitched note is the modulation introduced by the scanning spot. If the disc speed is high and the signal is weak, it may easily happen that the only sound audible in a pair of phones will be the group frequency. Even so, this is no indication that a fair image cannot be received.

## Television Teems with Trials for Telexperimenters

Editor, RADIO NEWS:

In the interest of the science please allow me to make this suggestion: get the broadcast stations and the experimenters in television together and confine their experiments to the same type of scanning discs and same speed. You can well see the trouble that is sure to arise, with every different station using a different number of holes and with different-speed motors.

As yet I have not tried to receive any pictures from these stations on account of atmospheric conditions and the distance from the televisior; having confined my experiments to a simplified method of synchronism. I can get a stable speed on one frequency but, when shifting from one speed to another, great difficulty is experienced; and of course the layman will have even more trouble when he attempts this adjustment. Then too, how many television receivers do you suppose can be sold when the user is told how many discs will have to be changed before tuning from one station to another?

Please accept this criticism or rather this suggestion in the same spirit it is given.

WILMER N. BARNES,  
1120 No. 22 Street, Waco, Tex.

### A DAY-AND-NIGHT TASK

From one standpoint, our correspondent's good-natured protest may seem well justified; the numerous systems now projecting radio television, radio movies, radio photo-

graphs and the like seem to call for such activity on the part of an enterprising experimenter as our imaginative artist has portrayed.

However, the thing to be remembered is that all these transmissions are still, so

far as the working details are concerned, very much in the stage of experiment. *The* (Continued on page 475)

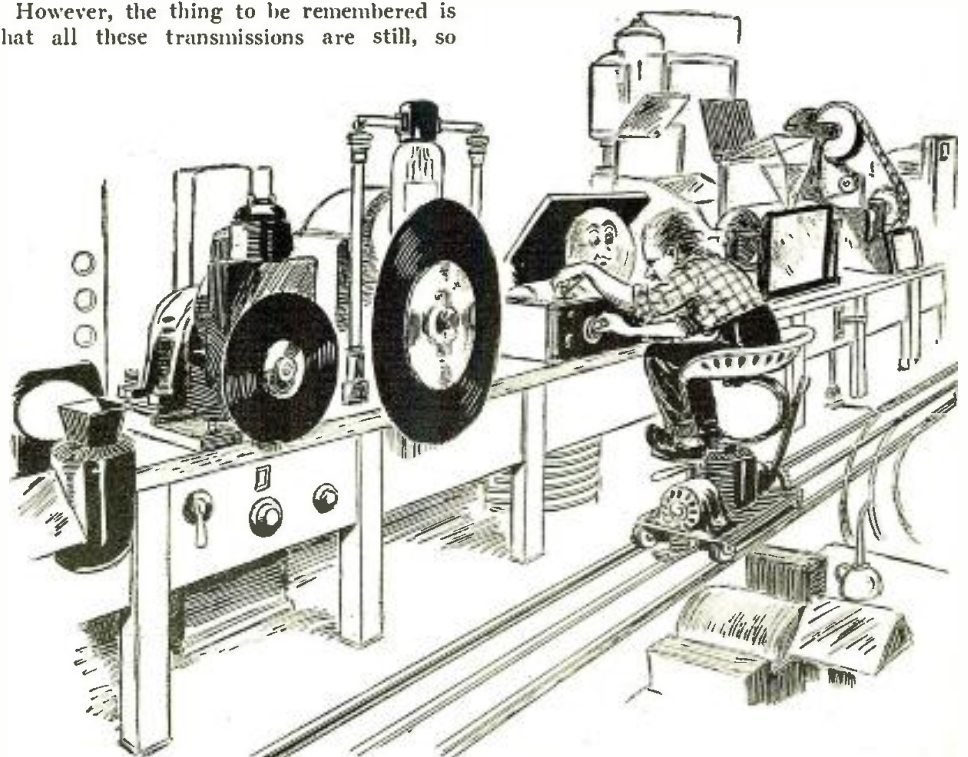

The paradise—or will it be purgatory?—of the radio experimenter who tries to keep up with everything new in radio imagery. (Drawn from imagination.)

# List of Broadcast Stations in the United States

Radio Call Letters	BROADCAST STA. Location	Wave (Meters)	Power (Watts)	Radio Call Letters	BROADCAST STA. Location	Wave (Meters)	Power (Watts)	Radio Call Letters	BROADCAST STA. Location	Wave (Meters)	Power (Watts)	Radio Call Letters	BROADCAST STA. Location	Wave (Meters)	Power (Watts)	
KDKA	East Pittsburgh, Pa.	316	5000	KGO	Oakland, Calif.	384	5000	WBAK	Harrisburg, Pa. (day)	300	500	WGN-WLIS	Chicago & Elgin, Ill.	416	15,000	
KDYL	Salt Lake City, Utah	234	15	KGRC	San Antonio, Texas	220	250	WBAL	Baltimore, Md.	256	500	WGR	Buffalo, N. Y.	500	750	
KEJK	Los Angeles, Calif.	252	250	KGRS	Amarillo, Texas	244	250	WBAP	Fort Worth, Texas	500	5000	WGST	Atlanta, Ga.	303	270	
KELW	Burbank, Calif.	229	500	KGTT	San Francisco, Calif.	220	50	WBAP	Nashville, Tenn.	240	5000	WHA	Madison, Wis.	333	750	
KEX	Portland, Ore.	278	2500	KGU	Honolulu, Hawaii	270	500	WBAX	Wilkes Barre, Pa.	250	100	WHAD	Milwaukee, Wis.	270	500	
KFAB	Lincoln, Neb.	319	5000	KGW	Portland, Ore.	492	1000	WBBC	Brooklyn, N. Y.	227	500	WHAM	Rochester, N. Y.	280	5000	
KFAD	Phoenix, Ariz.	322	500	KHY	Lacey, Wash.	246	50	WBBL	Richmond, Va.	234	100	WHAP	†Carlstadt, N. J.	236	1000	
KFAU	Boise, Idaho	286	2000	KHM	Los Angeles, Calif.	400	1000	WBBL	Louisville, Ky.	232	500	WHAS	†Louisville, Ky.	232	500	
KFBB	Hayre, Mont.	275	50	KHM	Harlingen, Tex.	236	100	WBBL	Troy, N. Y. (Monday)	306	500	WHAZ	Troy, N. Y. (Monday)	306	500	
KFBK	Sacramento, Calif.	275	100	KHS	Spokane, Wash.	370	1000	WBBS	Rossville, N. Y.	236	1000	WHB	Kansas City, Mo.	341	500	
KFBL	Everett, Wash.	224	50	KICK	Red Oak, Iowa (day)	322	100	WBBS	New York, N. Y.	236	100	WHBC	Waco, Tex.	236	100	
KFBU	Laramie, Wyo.	484	500	KJBS	San Francisco, Calif.	245	100	WBBS	Norfolk, Va.	236	100	WHBD	Bellefontaine, O.	222	100	
KFCB	Phoenix, Ariz.	244	123	KJR	Seattle, Wash.	349	2500	WBBS	Charleston, So. Car.	250	75	WHBF	Rock Island, Ill.	222	100	
KFCR	Santa Barbara, Calif.	211	100	KKP	Seattle, Wash.	203	15	WBBS	Chicago, Ill.	288	500	WHBL	Sheboygan, Wis.	204	250	
KFDM	Beaumont, Texas	484	500	KLCN	Blytheville, Ark. (day)	286	50	WBET	Salisbury, Md.	285	100	WHBP	Shenstown, Pa.	229	250	
KFDX	Shreveport, La.	236	250	KLDS	Independence, Mo.	270	1500	WBIS	Medford, Mass.	268	500	WHBQ	Memphis, Tenn.	232	100	
KFDF	Brookings, S. D.	545	500	KLRA	Little Rock, Ark.	204	50	WBIM	See WNAC			WHBU	Anderson, Ind.	220	15	
KFEL	Portland, Ore.	229	50	KLX	Oakland, Calif.	246	250	WBIM	Detroit, Mich.	211	100	WHBY	Philadelphia, Pa.	220	100	
KFEQ	St. Joseph, Mo.	231	1000	KLZ	Portland, Ore.	246	500	WBIM	Union City, N. J.	200	100	WHBY	West De Pere, Wis.	250	50	
KFEY	Kellogg, Idaho	232	10	KM	Idupont, Colo.	353	1000	WBIM	New York, N. Y.	236	500	WHBY	Minneapolis, Minn.	246	500	
KFGG	Boone, Iowa	210	10	KMA	Shenandoah, Iowa	395	1000	WBIM	Richmond Hill, N. Y.	309	500	WHBY	Chicago, Ill.	234	50	
KFH	Wichita, Kan.	246	500	KMCB	see KLDs			WBIM	Terre Haute, Ind.	208	100	WHBY	Cleveland, Ohio	265	500	
KFHA	Gunnison, Colo.	250	50	KMED	Medford, Oregon	270	50	WBIM	Birmingham, Ala.	303	250	WHBY	New York, N. Y.	395	500	
KFI	Los Angeles, Calif.	468	5000	KMIC	Ingleswood, Calif.	224	250	WBIM	Wilkes Barre, Pa.	250	100	WHBY	Des Moines, Iowa	535	6000	
KFIF	Portland, Ore.	229	50	KMJ	Fresno, Calif.	366	50	WBIM	Tilton, N. H.	232	500	WHBY	Englewood, N. J.	205	10	
KFIO	Spokane, Wash.	246	100	KMJ	Clay, Neb.	250	250	WBIM	Wellesley Hills, Mass.	384	100	WHBY	Chicago, Ill.	306	5000	
KFIU	Juneau, Alaska	225	10	KMMJ	Tacoma, Wash.	255	500	WBIM	Springfield, Mass.	333	500	WHBY	Philadelphia, Pa.	228	100	
KFIZ	Fond du Lac, Wis.	268	100	KMOX	†St. Louis, Mo.	300	5000	WBIM	Boston, Mass.	333	15,000	WHBY	Staubenville, Ohio	250	50	
KFJB	Marshalltown, Iowa	248	100	KMTR	Los Angeles, Calif.	516	500	WBIM	Mansfield, Conn.	535	500	WHBY	Elizabeth, N. J.	204	250	
KFJJ	Oklahoma City, Okla.	273	5000	KNCR	Santa Monica, Calif.	375	500	WBIM	Canton, N. Y.	244	500	WHBY	Elkins Pk., Pa. (Sunday)	441	50	
KFJF	Astoria, Ore.	250	50	KNX	Los Angeles, Calif.	337	500	WBIM	Pittsburgh, Pa.	461	500	WHBY	Chicago, Ill.	234	50	
KFJM	Grand Forks, N. D.	333	100	KOA	Denver, Colo.	326	5000	WBIM	Columbus, Ohio	234	250	WHBY	†Chicago, Ill.	306	5000	
KFJN	Portland, Ore.	240	100	KOAC	Corvallis Oregon (day)	370	7000	WBIM	Lincoln, Neb. (day)	380	500	WHBY	Staubenville, Ohio	250	50	
KFJO	Fort Dodge, Iowa	232	100	KOAG	State College, New Mex.	500	5000	WBIM	Northfield, Minn.	286	500	WHBY	Elizabeth, N. J.	204	250	
KFJZ	Fort Worth, Texas	250	50	KOCH	Omaha, Neb.	258	250	WBIM	Camden, N. J.	244	500	WHBY	Poynette, Wis.	217	20	
KFKA	Greeley, Colo.	250	500	KOCW	Chickasha, Okla.	252	250	WBIM	Baltimore, Md.	234	500	WHBY	Topeka, Kan.	204	250	
KFKB	Milford, Kansas	242	1500	KOIL	Council Bluffs, Iowa	319	5000	WBIM	Carlisle, Pa.	244	500	WHBY	Utica, N. Y.	238	150	
KFKU	Lawrence, Kansas	254	500	KOIN	†Portland, Oregon	319	1000	WBIM	Asbury Park, N. J.	240	500	WHBY	Montgomery, Ala.	231	15	
KFKZ	Kirksville, Missouri	225	100	KOMO	Seattle, Wash.	309	1000	WBIM	Rapid City, So. Dak.	248	100	WHBY	Easton, Conn.	231	15	
KFLV	Rockford, Ill.	268	100	KORE	Eugene, Ore.	200	50	WBIM	Burlington, Vermont	261	100	WHBY	St. Louis, Mo.	258	250	
KFLX	Galveston, Texas	270	100	KOW	Denver, Colo.	219	250	WBIM	Burlington, Vermont	261	100	WHBY	Bay Shore, N. Y.	211	500	
KFMX	Northfield, Minn.	236	500					WBIM	Carthage, Ill.	250	50	WHBY	Miami Beach, Fla.	248	1000	
KFNF	Shenandoah, Iowa (day)	461	2000					WBIM				WHBY	Philadelphia, Pa.	349	500	
KFOA	Seattle, Wash.	447	1000					WBIM				WHBY	Milwaukee, Wis.	270	250	
KFOB	Long Beach, Calif.	242	1000					WBIM				WHBY	Norfolk, Va.	210	100	
KFOR	Lincoln, Neb.	217	15					WBIM				WHBY	Norfolk, Va.	333	500	
KFPL	Dublin, Texas	275	15					WBIM				WHBY	Norfolk, Va.	286	250	
KFPM	Greenville, Texas	231	15					WBIM				WHBY	Kokomo, Ind.	236	250	
KFPW	Sulphur Springs, Ark.	233	50					WBIM				WHBY	Jedediah, Iowa	240	250	
KFPY	Spokane, Wash.	246	250					WBIM				WHBY	Providence, R. I.	484	500	
KFQB	Fort Worth, Texas	333	1000					WBIM				WHBY	Pittsburgh, Pa.	270	500	
KFQD	Anchorage, Alaska	345	100					WBIM				WHBY	Jacksonville, Fla.	341	1000	
KFQU	Holy City, Calif.	220	100					WBIM				WHBY	Cleveland, Ohio	227	500	
KFQW	Seattle, Wash.	217	100					WBIM				WHBY	†Mt. Prospect, Ill.	263	5000	
KFQZ	Hollywood, Calif.	232	250					WBIM				WHBY	Sarasota, Fla.	238	250	
KFRC	San Francisco, Calif.	450	1000					WBIM				WHBY	LaSalle, Ill.	230	100	
KFRD	Columbia, Missouri	450	500					WBIM				WHBY	Red Bank, N. J.	263	100	
KFSD	San Diego, Calif.	441	500					WBIM				WHBY	Ypellanti, Mich.	220	15	
KFSG	Los Angeles, Calif.	252	500					WBIM				WHBY	Decatur, Ill.	213	250	
KFUL	Galveston, Texas	258	500					WBIM				WHBY	New Orleans, La.	263	100	
KFUM	Colorado Spgs., Colo.	486	1000					WBIM				WHBY	Chicago, Ill.	389	500	
KFUO	†Clayton, Mo.	545	1000					WBIM				WHBY	Lewistown, Pa.	214	100	
KFUP	Denver, Colo.	227	100					WBIM				WHBY	New Orleans, La.	235	30	
KFUR	Ogden, Utah	225	50					WBIM				WHBY	Gadsden, Ala.	238	100	
KFVS	Culver City, Calif.	226	250					WBIM				WHBY	JJD	Mooseheart, Ill.	386	1000
KFVG	Independence, Kan.	225	50					WBIM				WHBY	Gary, Ind.	232	500	
KFVW	Cape Girardeau, Mo.	224	50					WBIM				WHBY	†New York, N. Y.	454	30,000	
KFWB	Los Angeles, Calif.	353	1000					WBIM				WHBY	San Juan, Porto Rico	322	500	
KFWC	Ontario, Calif.	248	100					WBIM				WHBY	East Lansing, Mich.	278	500	
KFWF	St. Louis, Mo.	214	100					WBIM				WHBY	Lacon, N. H.	224	50	
KFWI	San Francisco, Calif.	268	500					WBIM				WHBY	Joliet, Ill.	276	100	
KFWM	Oakland, Calif.	236	500					WBIM				WHBY	Webster, Mass.	229	100	
KFWO	Avon, Calif.	301	250					WBIM				WHBY	Indianapolis, Ind.	252	250	
KFXD	Jerome, Idaho	204	15					WBIM				WHBY	La Crosse, Wis.	231	500	
KFXF	Denver, Colo.	283	250					WBIM				WHBY	Chicago, Ill.	216	50	
KFXJ	†Edgewater, Colo. (night)	210	50					WBIM				WHBY	Youngstown, Ohio	214	50	
KFXR	Oklahoma City, Okla.	224	50					WBIM				WHBY	Jersey City, N. J.	219	250	
KFXZ	Flagstaff, Ariz.	205	25					WBIM				WHBY	Battle Creek, Mich.	213	50	
KFYO	Breckenridge, Tex.	211	100					WBIM				WHBY	New York, N. Y.	219	250	
KFYR	Bismarck, N. Dak.	250	250					WBIM				WHBY	Galesburg, Ill.	217	100	
KFA	Spokane, Wash.	261	2000					WBIM				WHBY	New Orleans, La.	252	50	
KGB	San Diego, Calif.	248	100					WBIM				WHBY	Brookville, Ind.	219	100	
KGBU	Tucson, Ariz.	234	100					WBIM				WHBY	Amherst, N. Y.	217	5000	
KGBV	Ketchikan, Alaska	400	500					WBIM				WHBY	Ludington, Mich.	200	15	
KGBW	St. Joseph, Mo.	288	100					WBIM				WHBY	†Buffalo, N. Y.	207	750	
KGBX	Columbus, Nebraska	222	50					WBIM				WHBY	Lancaster, Pa.	252	50	
KGBZ	York, Nebraska	213	100					WBIM				WHBY	Cincinnati, Ohio	248	500	
KGC	Decorah, Iowa	218	10					WBIM				WHBY	Wky	Oklahoma City, Okla.	288	150



Main broadcast station list with columns for Radio Call Letter, Broadcast Sta. Location, Wave (Meters), Power (Watts), and multiple columns for other stations.

\* Allowed higher daylight power. \*\* Standard of constant-frequency transmission. † Remote Control.

LIST OF CANADIAN BROADCAST CALLS

Table listing Canadian broadcast calls with columns for call letters, location, wave, and power.

LIST OF SHORT-WAVE STATIONS OF THE WORLD

U. S. Short-Wave Stations will prefix their experimental calls with W or K after October 1, 1928; and others with their allotted national letters on or before January 1, 1929.

Large table listing short-wave stations worldwide, organized by continent (Africa, Australia, Austria, Belgium, Canada, Dantzic, Denmark, England, France, Germany, Holland, Italy, Japan, Java, Mexico, Morocco, Norway, U.S.S.R. (Russia), Spain, Sweden, Switzerland, United States).

THIS list of the short-wave broadcast stations throughout the world is not complete, although we have endeavored to list every station of whom we have heard reports; since in many cases reliable information about the programs, wavelength and power of the stations cannot even be obtained from the stations themselves. (See page 456.)

# Rays of Justice

by C. Sterling Gleason



IT was a tense moment for the thousands gathered there in the great bowl of the Coliseum—those thousands of intrepid film fans who had risked crumpled fenders, crushed hats, comfort, and almost life itself, simply to gain a glimpse of that great man who is not only the chief idol of the film fans of the world, but a far-famed philanthropist as well. It was an equally interesting moment for millions of happy families everywhere, who, through the agency of television, were seeing with equal clearness from the privacy of their own homes every detail in the spectacle which was taking place in Los Angeles' great amphitheater. The palpitating hearts of countless devoted film fans throbbed in unison to realize that the deep, vibrant, resonant chest tones issuing from the loud speaker were the voice of him whom a whole world idolizes as one of supreme daring, of unsurpassed generosity, and of a breadth, depth, and thickness of character that mark him as the biggest and best film hero in the industry. The eyes and ears of the whole world were turned toward that little platform in the blaze of a hundred spotlights, where Harold Dare, Flicker Films' famous favorite, was concluding the few well-chosen remarks with which he was bestowing upon Southern California a boon for which generations to come would ever bless his name.

"To you, Mr. Mayor, as representing the people of the Southland, I present this key—the key to progress, the key to prosperity, the key to that great future which shall be Southern California's. May this be merely the beginning of a long advance, onward and upward, bigger and better, toward that world supremacy which is the goal of every true booster. Here is power, Mr. Mayor. May it ever be used for the greatest good to the greatest number."

Amid a thunder of applause, the Mayor took the little gold key and held it up before the eye of the television that all the millions in that vast outside audience might see. In a long eulogy of fulsome tribute, he traced for his audience the progress of Harold Dare's activities in this latest manifestation of the great screen star's boundless benevolence and whole-souled public spirit. He told how Harold Dare, ever watchful of the public welfare, ever lead-

ing in everything that was bigger and better, had realized that Southern California faced a future power famine if means of expansion were not provided; how he had initiated and backed the movement for a great public-owned power system; how at every step he had been hampered by the insidious machinations of a certain power corporation, which saw in this project dangerous competition; and how, even after an overwhelming majority at the polls had demonstrated the public's confidence in the project, material had mysteriously disappeared from the site, important shipments had been unaccountably delayed or sidetracked, and a host of sinister occurrences had demonstrated powerful influences at work to undermine the screen star's great work of public benefaction. But that same indomitable courage and unswerving devotion to the public weal that have made Harold Dare the outstanding world figure that he is, had ever sustained him through all these crises and carried him onward and upward to his goal. Success was his at last! This key, when turned in the little lock on the control panel before the speaker's table, would send out an electrical impulse over many miles of copper wire, through the city and across desert wastes, over plain and mountain, to a structure of concrete and steel located among the desolate, rugged fastnesses of the high Sierras. Here, at the head of a great blue lake fed from the melting snows, tons of water held chained by man's masterful mind would be released to do his bidding. Down from the great turbines whirled by the enslaved giant would course a cataract of power, of electrical energy which, guided by three tiny threads of copper flung across gorge and river, would speed the wheels of industry to an activity heretofore undreamed.

"To you, Mr. Dare," concluded the Mayor, in a final burst of eloquence, with a sweeping gesture which summed up all the admiration, respect, and gratitude due so great a public benefactor, "Southern California owes a debt it can never repay!"

"On behalf of the citizens of the City of Los Angeles and of all Southern California as well, I accept this key; to their benefit, and that of posterity, I hereby dedicate the new Wolf Creek power line."

He inserted the little gold key in the

lock switch. A buzzer sounded; all the lights winked out, except a single brilliant spotlight trained upon the speaker's platform; upon three monitoring television screens suddenly appeared a vista of huge dynamos against a background of switch-studded panels jewelled with control lights; and in the loud speakers rose an ascending whine as tons of water, surging through the great turbines, whirled the mighty generators faster and faster.

The radio audience now beheld a strange sight. Down the middle of the television screen ran a narrow line, separating two distinct pictures. On the left, the Mayor and Harold Dare were acknowledging the storm of applause which swept the Coliseum; on the right appeared a panorama of switchboards and controls, at which operators were bringing up the Wolf Creek line into phase; while from the loud speaker issued a hum of busy dynamos against a background of frantic applause. The Dare technicians had scored another success. By masking opposite halves of the fields of two television transmitters, one at Wolf Creek and another at the Coliseum, and by combining the currents as they were fed into the transmitter broadcasting the event, the two scenes were reproduced side by side upon the receiving screens, much as in the double exposures common in motion-picture photography. The sound currents were simply superimposed upon one another, the relative proportions being regulated by operators at the conventional gain controls. The television circuits had required many days of careful balancing and adjustment before the synchronization had been perfected; the ultimate success was indeed an engineering triumph.

Suddenly Harold Dare, bowing and acknowledging with matchless ease the tremendous clamor of applause of that enormous audience, sensed that something was wrong. He turned—and stood transfixed. The applause of thousands suddenly died; the smile of the Mayor faded from his face; for the silver screen of the televisior flickered and was dark.

For a few endless seconds, Harold Dare and the Mayor stared, amazed, aghast, incredulous. An operator hurried over from the control box and spoke a few words in a low voice. The Mayor gasped and paled; but dauntless Harold Dare stepped calmly to the front and addressed the puzzled audience.

"Friends, there is no use in keeping the truth from you. The Wolf Creek line is dead."

A murmur of amazement, mingled with indignation, swept the great gathering. Harold Dare raised his hand for silence.

"Friends, before you judge or blame, let me tell you a few facts about the construction of the Wolf Creek line. The wires are run in duplicate—two complete sets upon each tower. If an insulator should fail, or a wire break, the other circuit would still maintain service. There is not one chance in a million that both lines should fail at the same moment—and of all moments, the very moment when failure would mean the greatest personal blow possible, a spectacular debacle calculated to shake the confidence of the public in this project and turn the admiration of the world to ridicule. Let me remind you, ladies and gentlemen, that although this line, strung from sturdy towers founded upon eternal rock, is made to withstand the ravages of the centuries, a single blast of dynamite might easily send one massive tower toppling into a ravine, doing damage it would take days to repair. As you all know, there are forces bitterly opposing this great project; they could have chosen no better time to strike than now. No apology I could make would suffice; yet I promise you that I shall not sleep nor rest until the fendish perpetrator of this crime against humanity is brought to justice!"

The ovation these words received was tremendous. The thousands went forth with the warmest sympathy for the heroic stand of their great friend and protector. Not a woman but sighed a little in admiration for this fearless hero who thus smiled coolly in the very face of disaster; not a man but clenched his fist and protruded his jaw with just indignation toward the unprin-

ciple persecutors of the public's dauntless champion.

Who might be behind these dark and devious deeds? One name was whispered about with steadily growing persistency. Remembering the countless similar outrages perpetrated in the past by the monster, the public intuitively suspected Dandy Diavolo, that arch super-villain of the Flicker Films, who had ever pursued Dare with increasing relentlessness through the superlative Flicker Films, and in real life as well. Dare himself did not doubt that his arch-enemy was behind this plot, but his detectives were unable to find any trace of the villain, who had left for parts unknown to spend a short vacation between pictures.

At two o'clock the next afternoon came news that rocked all Southern California. The trouble in the Wolf Creek line had been located. Three insulators of the six on a single tower located on the edge of a cliff above a deep valley had shattered, allowing the wires to fall and short-circuit both lines. Working in continuous shifts, repairmen replaced the insulators in a few hours.

The new insulator had lasted barely ten minutes. The startled linemen had scarcely gathered up their tools when a terrific arc rent the air. One huge insulator, then a second, shattered into a thousand pieces, as if struck by a giant's hammer. Two long cables swung together and were welded into one; then as the intense heat melted the stranded copper, the severed wires traced tattered shreds of flame as they slipped along the steel tower to the ground.

New insulators were rushed from the nearest supply station. Engineers hastened to the spot to make observations. While it was ostensibly their opinion that both insulators had developed flaws, possibly through strain while being hoisted to their

position several hundred feet in the air, in their hearts was developing a fear that some error had been made in the design. The insulators used had been tested under conditions so much more severe than any met in practice that failure was unthinkable. Yet nothing seemed to stop the mad surge of half a million volts across this one apparent weak spot in the whole Wolf Creek line. Frankly, they were baffled.

The new insulator was hoisted to its place under the strict scrutiny of world-famous electrical engineers. It had been given a thorough test and was apparently electrically perfect. The voltage was applied gradually. At Wolf Creek station, a group of engineers watched tensely the meters registering line conditions, while at the tower itself, motion-picture cameras, equipped with telescopic lenses, made slow-motion pictures of the insulator from various angles. At length the line was carrying its full load. For moments the engineers watched, while reel after reel of film ran swiftly through the cameras.

Suddenly the meters at Wolf Creek quivered. As suddenly the needles shot across the scale; great circuit-breakers tripped; an arc flared and was quenched; and the generators whined at high speed as the load was removed from the line. The frightened engineers stared helplessly at one another. The Wolf Creek lines were dead!

It was an old story the engineers saw re-enacted before their eyes as a few hours later they sat in the projection room of the Dare laboratories at Hollywood. A tongue of flame suddenly bridged the gap between a cable and the tower. It grew to a broad ribbon, and slowly two great strings of bell-shaped insulators separated from their mountings amid a shower of large fragments of porcelain. As if in sympathy, another insulator on the other side of the tower also burst into splinters of porcelain and the three floated leisurely to ground, while the cables tangled, melted, and dropped out of sight in the canyon.

(Continued on page 479)

"A million people gazed horror-stricken for to the topmost cross-arm of the huge tower clung two living skeletons—skeletons whose hands clutched pliers, skeletons that shouted hoarsely for lights!"

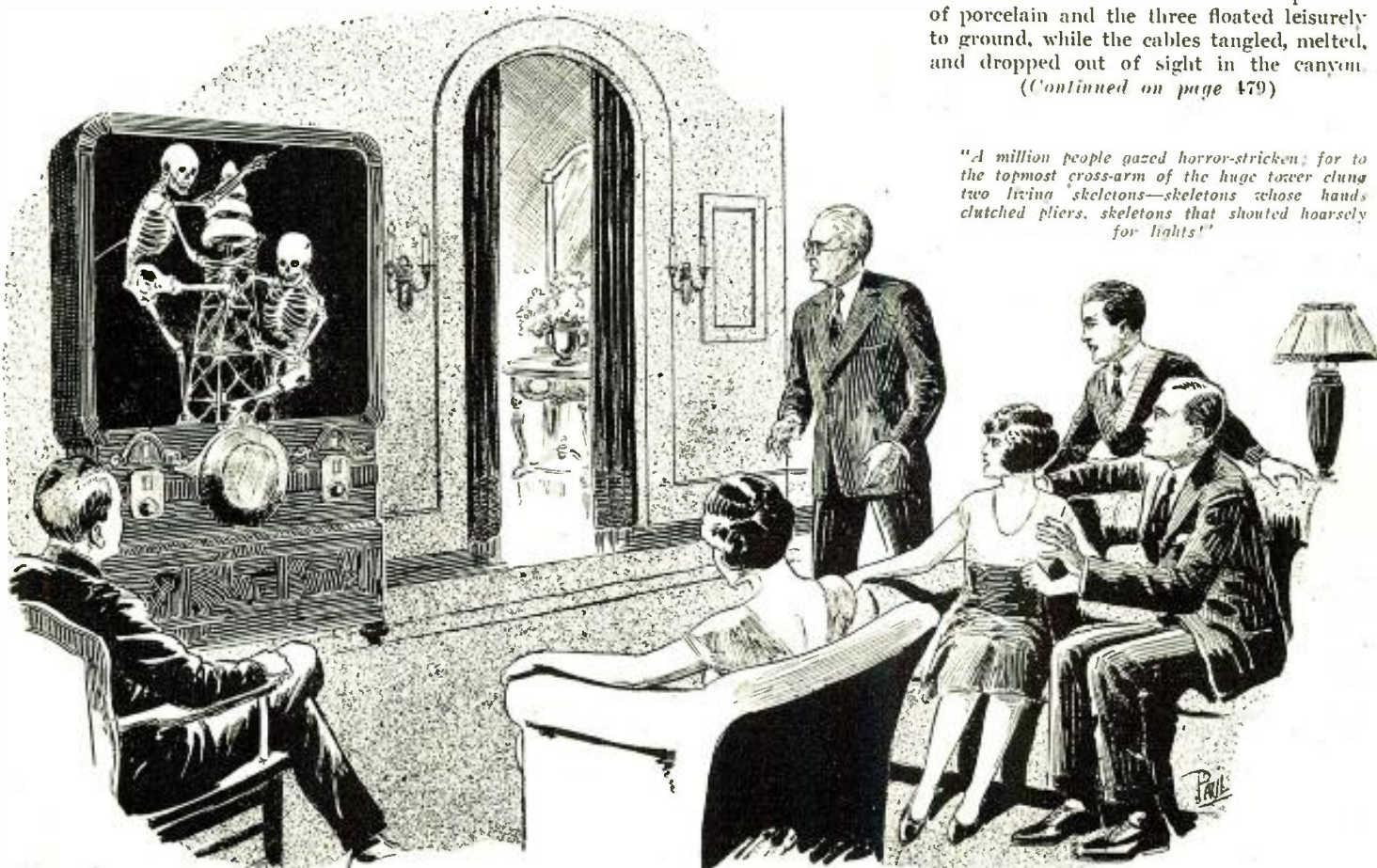

# What's New in Radio

## Two-Way Regulator Corrects Line-Voltage Variation

THE small box-shape device illustrated in this column is a voltage regulator for use in connection with radio receivers. It



To obtain 110-volt current from a variable or non-standard lighting supply, plug the receiver's power-unit lead in at B on this device, and insert C in a light-socket. Adjustment is made by knob A, as shown in the diagram at the right.

has been designed to correct the house-supply voltage to 110, the potential usually required by electric sets. It will operate in any A.C. circuit, provided the voltage is not greater than 130 nor less than 90, and it has an output of 60 watts, which is ample for the operation of the average set.

It is not difficult to appreciate the importance of an A.C. line-voltage regulator, for the chief cause of dissatisfaction with electric receivers has been due to the short life of the tubes. It was first thought by the experimenters that this condition resulted from poorly-designed tubes, but investigation has shown that variations in the 110-volt house-supply current usually are responsible for overloading the filaments and reducing tube life. A majority of the power transformers available for heating tube filaments are designed for 110-volt operation and an increase in the input voltage will cause a proportional increase in the output. Therefore, in cities where the house potential rises to 120 and 130 volts during the evening, the tube filaments operated with A.C. are dangerously overheated. On the other hand, insufficient power is frequently the cause of poor reception.

The voltage-regulating device illustrated on this page provides the broadcast listener with a very simple method of regulating the input voltage to a receiver. It is a simple auto-transformer, equipped with a special A.C. buzzer which vibrates when the potential applied to the receiver reaches 110 volts. The interesting feature of the regulator is that the voltage-indicating buzzer operates automatically during adjustment, but is turned off by the removal of the operator's hand from the adjustment knob.

Among other advantages it possesses, this regulator will correct the house-supply po-

tential to 110 volts for the operation of the radio receiver, regardless of whether the line-voltage is above or below this value; whereas resistors are capable only of reducing the voltage. Secondly, the unit has a sufficiently wide range to cover all conditions; it will increase the voltage to normal value from as low as 90 volts, or it will decrease the voltage to normal from as high as 130 volts. Thirdly, there are eight voltage taps, thus providing a very close adjustment. And fourthly, it is highly efficient, as it regulates the voltage by reactance, rather than resistance.

The appearance of the device is clearly shown in the accompanying picture; it is housed in a metal box  $4\frac{1}{4} \times 4\frac{1}{4} \times 3\frac{3}{4}$  inches and weighs 3 pounds. It is provided with a cord and plug for connection

to the lamp socket, and also with a 110-volt receptacle for the plug of the power transformer; the only adjustment is a knob which operates an eight-point switch.

The way in which the unit is connected is shown in the schematic wiring diagram. Another illustration shows the mechanical construction of the combination switch which automatically connects the voltage-indicating buzzer when the voltage regulator is being adjusted. It will be noticed that the shaft turned by the adjustment knob is connected to the contact arm of SW1 and that, as the shaft is turned to the right, the contact arm of SW1 is turned and the switch SW2 is closed. However, as soon as pressure is removed from the knob, a spring opens switch SW2, thus disconnecting the buzzer.

Manufacturer: R. B. M. Manufacturing Company, Logansport, Ind.

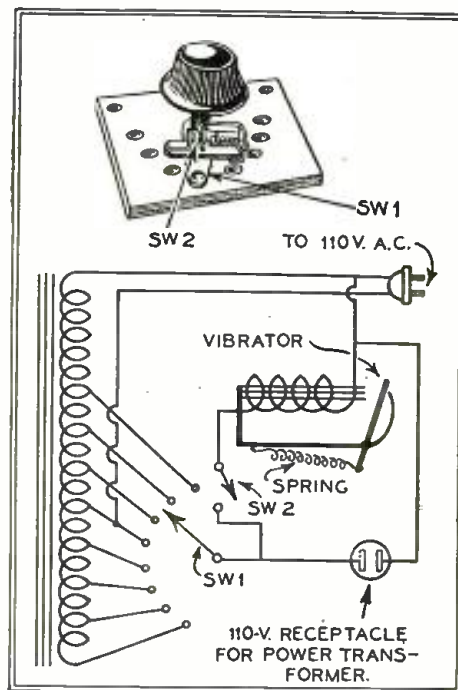

The auto-transformer steps the voltage either up or down, as required. The correct setting is indicated automatically by the buzzer; SW2 functions only during the operation of adjustment.

## New Short-Wave Plug-In Coils Small and Rugged

A well-known manufacturer of short-wave receiving equipment has developed some new plug-in coils which are small and of very rugged construction. The coils are sold in sets of three, as shown in the illustration. They provide a receiver with a wavelength range of 15 to 130 meters.

A complete set of these coils consists of three interchangeable coils, a suitable base and an adjustable primary, which is mounted on the base. In each case the interchangeable coils have two windings, a secondary and tickler. The coils may be used in the standard fixed-tickler, capacity-controlled regenerative circuit, with a 140-mmf. variable grid-tuning condenser and a 250-mmf. variable feed-back condenser. With this arrangement the smallest coil provides a wavelength range of 15 to 33.5 meters, the next largest coil has a range of 31.5 to 68 meters, and the largest coil has a range of 57 to 133 meters. Also, coils of the same design are available for higher and lower wavelengths.

The picture immediately below clearly shows the skeleton construction of the coils. The

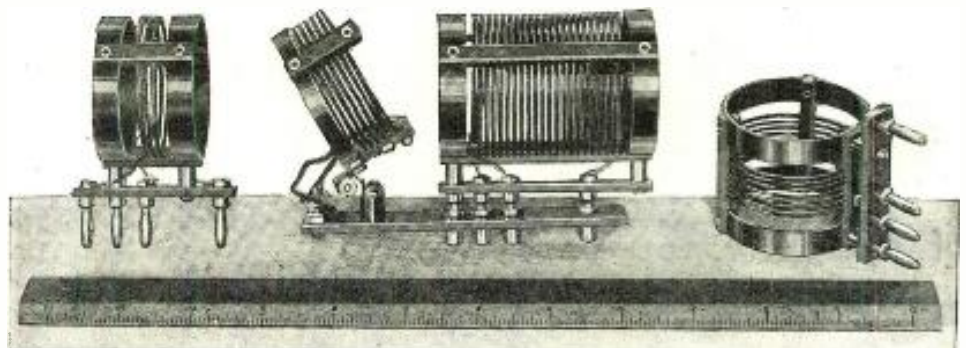

The compactness and convenience of these coils for the short-wave operator may be readily seen. The secondary-tickler coil at the left is for the 15-33.5-meter range, and that at the right for 31.5-68 meters. The 57-133-meter coil is shown plugged into the base; to which the primary is permanently attached, as it is the same in all combinations.

secondary winding consists of the necessary number of space-wound turns of enameled wire. The tickler winding is self-supporting and is wound with cotton-covered wire. The adjustable primary coil is also space-wound with enameled wire.

Manufacturer: Aero Products, Inc., Chicago, Ill.

### Sturdy New 110-volt Switches for Electric Receivers

SWITCHES of improved design have recently been placed on the market for use in connection with A.C.-operated receivers. Electrically, these switches are identical with those previously available, but their mechanical design has been changed to render them better suited for front-panel mounting. They are of the standard 110-volt type, and may be operated with knobs of the type used for other radio apparatus. Their electrical rating is 3 amperes at 250 volts.

There is a considerable difference in construction between switches which are used in battery sets and those which must be used for A.C. receivers. In battery sets any single-pole switch may be used, as the potential in the filament circuit is never greater than six volts. On the other hand, in A.C. receivers the switch is connected in a 110-volt circuit, and the only switches approved for this purpose are snap switches having a heavy spring which makes or breaks the circuit rapidly. Because of the high voltage in the circuit this type of construction is necessary in order to prevent arcing between the poles of the switch.

Of necessity snap switches are quick in action and, for this reason, the usual radio knobs have not been used for their operation. Most of the 110-volt switches which have been available are of the toggle type, and this has disappointed many set constructors who have attempted to balance the arrangement of apparatus on their front panel.

The switches illustrated on this page are of the usual toggle type, but there have been added to them ingenious mechanical devices which permit operation by either a knob or plunger or in connection with a rheostat knob. In the case of the rheostat combination, as the knob of the unit is turned to the "off" position the switch turns the set off, and *vice versa*. The drawing shows the switch turned on, and dotted lines indicate the "off" position. In the knob-operated switch a ball-and-socket connection joins the shaft with the switch and, in the center switch, a knee joint couples the plunger with the contact arm.

Manufacturer: The Hart and Hegeman Mfg. Co., Hartford, Conn.



The power switch shown above is controlled from the panel of a set by its knob; which is of conventional appearance, but whose action, however, is to flip the sturdy toggle which controls the input from the lighting mains.

The combination of rheostat and switch shown at the right differs from the usual one in that the switch is a heavy-duty one, built to make and break circuits carrying full house-lighting voltages, and therefore suitable for use in the power line feeding the unit.

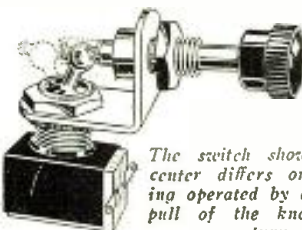

The switch shown in the center differs only in being operated by a shove or pull of the knob, not a turn.

### Radio Outlets Attractive For Home Wiring

THE convenient radio outlets pictured on this page will be appreciated by fans who are anxious to improve the appearance of their installations. One outlet is equipped with tip jacks for the aerial and ground connections and the other is provided with a seven-wire jack and plug for the battery cable. Both outlets are made of lacquered brass and are the same size as standard 110-volt power outlets.

With the battery-wire outlet the jack is mounted on the frame and the plug is free for connection with the battery cable. The plug is made in two parts and may be taken apart for convenience in soldering the seven wires of the battery cable to its terminals. Wires are soldered to the jack for connection to the batteries.

It is not necessary to elaborate extensively on the ways in which these outlets may be used, as they are very convenient for a number of purposes. Of course, the way in which they may be employed in the individual installation depends largely on the arrangement of the radio apparatus. A radio experimenter might mount them in the wall or on the top of a worktable to enable him to quickly connect batteries when testing receivers. They are just as valuable to the radio listener who may wish to wire his house so that the set may be moved from one room to another quickly and easily; and for many other purposes which will readily occur to the user. Such wiring is especially desirable during new construction of residences and apartments.

Manufacturer: Yazley Manufacturing Company, Chicago, Illinois.

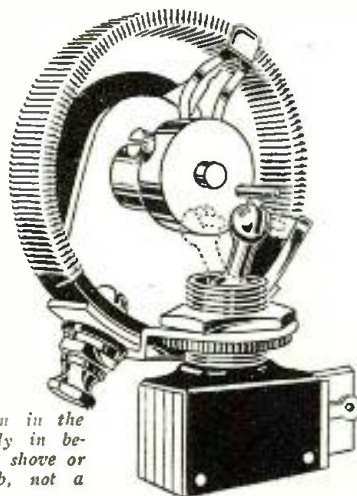

### Battery-Cable Connector Handy for Builder

IMPROVEMENTS and refinements are possible in all manufactured products, including such simple items as battery-cable plugs as well as more complicated radio parts. Although the usual cable connector

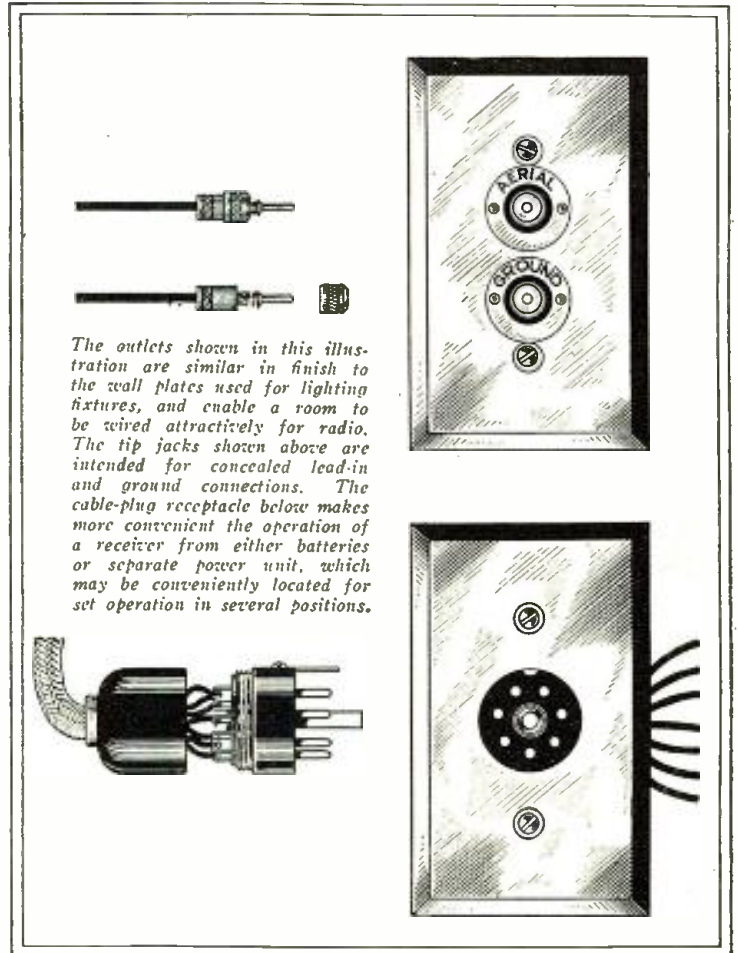

The outlets shown in this illustration are similar in finish to the wall plates used for lighting fixtures, and enable a room to be wired attractively for radio. The tip jacks shown above are intended for concealed lead-in and ground connections. The cable-plug receptacle below makes more convenient the operation of a receiver from either batteries or separate power unit, which may be conveniently located for set operation in several positions.

is quite satisfactory for the purpose for which it is intended, a device of improved design which possesses several new features has been recently developed and placed on the market; it is illustrated in the drawings on the following page.

In electrical design, the cable connector under discussion does not differ greatly from the usual product of this type. The cable consists of seven wires which are of different colors to permit identification; a seven-contact plug is soldered to the wires at one end of the cable and this plug fits into a receptacle which is mounted on the baseboard or panel of the receiver. The contact prongs of the plug are split so that they make good contacts in their respective sockets in the receptacle unit. Also, a lug and notch have been placed in the plug and the receptacle, respectively, to insure that the plug must always be inserted in the correct position.

An interesting feature of the cable connector is that it is available with either of two mounting receptacles, one of which is designed for baseboard mounting and the other for panel mounting; the construction of the two is shown in the drawings. Both types are made of molded bakelite, and the color of the wire to which each soldering lug connects is engraved on the back of the receptacle. The baseboard-type receptacle unit is fitted with a base and may be

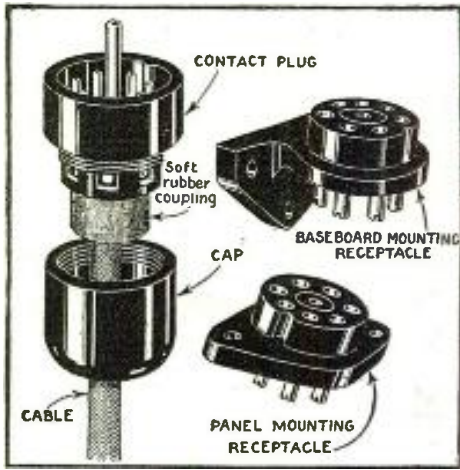

An attractively-designed battery cable and receptacles of two types designed for use in connecting its plug to a receiver.

mounted in a vertical position. A hole 1/4 inches in diameter is required to receive the panel-type receptacle unit; the unit is mounted on the rear of the panel and the plug is inserted in the hole. The design of both receptacle units is such that there is easy access to the lugs with a soldering iron, and the lugs have been tinned and slotted to facilitate the connection of wires.

The plug unit also of the cable connector is of molded bakelite, and is in three sections; the plug proper, an insulating separator, and a cap which protects the soldered connections. The connections of the plug are insulated carefully with bakelite partitions, so that a short-circuit of the wires is practically impossible, and a soft-rubber coupling prevents any abnormal strain on the wires. Also, if an open circuit should occur, the plug unit may be disassembled and a new battery cable soldered in place.

Manufacturer: Herbert H. Frost, Inc., Chicago, Ill.

### A Handy Time-Conversion Chart for the Short-Wave DXer

THE United States Department of Commerce recently has developed an international time chart which will prove to be a very useful article for radio listeners, particularly those who are interested in long-distance, short-wave reception. The chart is being printed by the Government and may be obtained at a cost of ten cents (coin, not stamps) by writing to the Superintendent of Documents, Government Printing Office, Washington, D. C. It is made of heavy cardboard and is reproduced in the next column.

Knowing the standard time and the longitude at any place on the earth, the corresponding standard time at any other place can be read directly from the chart. The inner circle is marked with the hours of the day, the white half for forenoon (a.m.) and black half for afternoon (p.m.); while the outer circle is marked off in degrees east and west of Greenwich. The inner circle may be revolved and by comparing the two scales, it will be seen that the time changes one hour for every 15 degrees change of longitude.

To obtain the time at any place in relation to the time at any other place, it is necessary only to set the time on the inner circle to the longitude of the place where the time is known and to read the time indicated at the longitude of other place.

It should be noted that the 180° meridian corresponds to the international date line. In going across this line from east longitude to west longitude, a day is lost; in the other direction, a day is gained. That is, a place just east of this date line is one day later than is a place just west of this line.

For an example of the use of the chart: it is desired to know the time in Alaska, in India, in Japan, and in New Zealand when it is 9.15 a.m., March 2, in Washington, D. C.

Washington, D. C., is in the eastern-time zone of the United States and takes the time of the 75th meridian west. Setting the 9 on the white half of the inner circle so that it coincides with 75° west longitude, we are ready to read off the time in the other countries. Following the outer circle until the longitude of Alaska is reached, it will be found the 4 on the white half of the inner circle coincides with this line, which indicates that it is 4.15 a.m., March 2. In the same way India is found half-way between 7 and 8 on the black half of the inner circle, which indicates 7.30+15 or 7.45 p.m., March 2, as the corresponding time for India. Likewise, the time indicated for Japan is 11.15 p. m., March 2.

New Zealand is found coincident with 130 on the white scale, which indicates forenoon, and since we have already passed the 180° meridian, the time indicated is that of the next day or 1.45 a.m., March 3.

### Map Makes Handy Record of Continental Reception

A CONVENIENT departure, from the usual wall-size map heretofore available to the radio fan for logging purposes, is to be found in a new copyrighted radio chart of the United States, Canada, Mexico and the West Indies. It is mounted on a substantial sheet of heavy drawing-board and measures only 18 x 12 inches; so that it may be laid on the table or held in the lap. This map is furnished with 100 colored markers to record stations heard; and near the names of each city the calls of the various broadcast stations located there are printed in such an arrangement that a separate marker may be used for each station without undue crowding.

Manufacturer: Radio Map Company, Los Angeles, Calif.

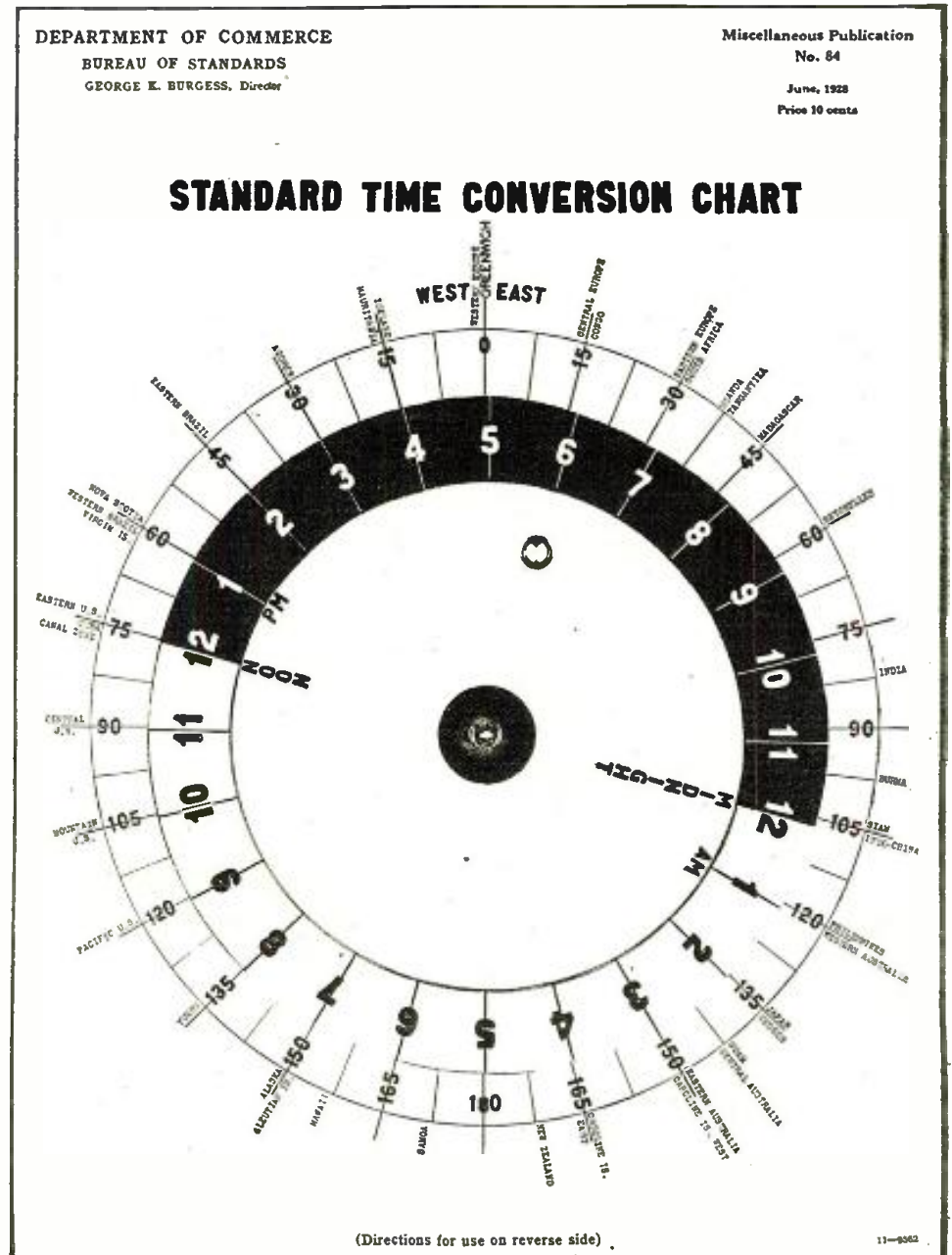

Uncle Sam's handy calculator, somewhat reduced. The circle of hours is pivoted in the center.

# PUTTING THE AERIAL IN SHAPE FOR WINTER

By I. B. Robbins

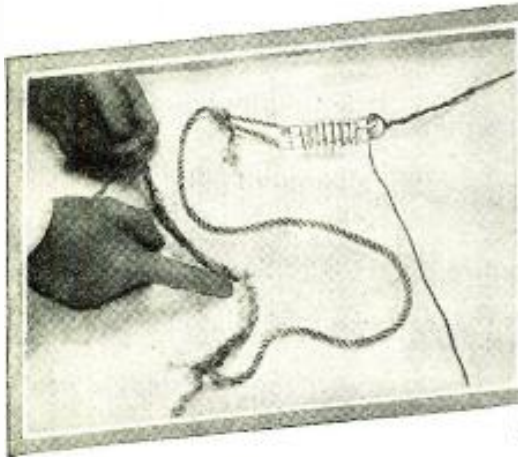

Fig. A. Lazy men should replace frayed halyards before they break. It's a good deal easier then.

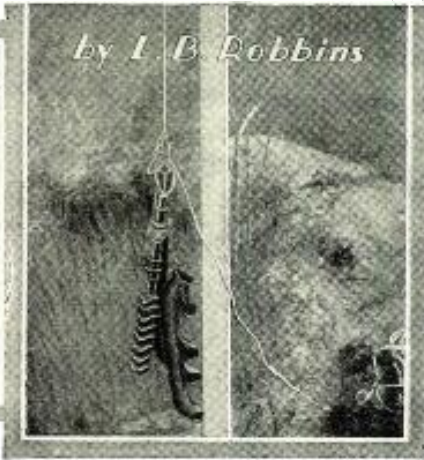

Fig. B. Only weight counts in this position.

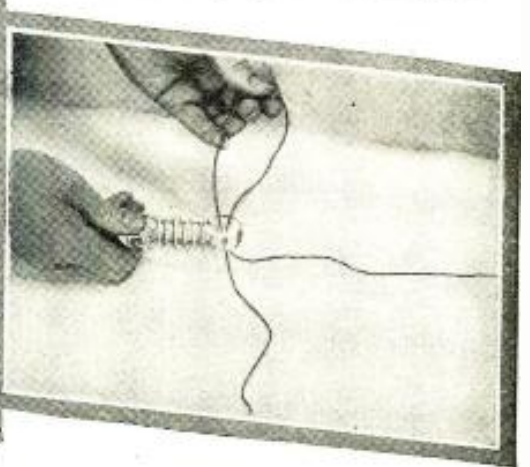

Fig. C. One piece of wire for aerial and lead-in may be fastened as shown here and in Fig. A.

NOTWITHSTANDING the number of indoor aerials and loops now used with ultra-sensitive radio receivers there are many more outdoor aerials, good, bad and indifferent. Almost anything will do in fair weather, so long as it hangs fairly steady and keeps dry; but winter weather, with its gales, snow, sleet and ice often wrecks even the best aerial systems and renders the receiver useless until the wires can be put back in order. Consequently, it behooves the radio owner to put up a good aerial and keep it in order so that wild winter weather will not ruin it in the first gale. To do this and to insure good reception throughout stormy periods, the following hints should be followed and every effort made to see that insulators are inserted properly and halyards are strong, and

chief trouble with the latter is that its effectiveness is limited by its elasticity while the counterweight will allow the halyards to contract or stretch as much as needed without disturbing the tension of the aerial. Either one or the other idea is practically necessary to overcome the tendency of the halyard to snap during extreme high winds, wet and dry weather and similar disturbing influences.

### ONE PIECE OR TWO

While it is always preferable to have the aerial and lead-in wire in one piece to do

Be sure to do a thorough job of soldering, however, and one that will not eventually allow the joint to corrode.

Avoid letting the lead-in hang over a flat roof or enter the room just above a window stool or ledge. (The diagrams in Fig. 3 illustrate why); this, of course, if the wire is bare. With insulated wire the chances for leaks are considerably less unless the insulation becomes broken.

No matter what the lead-in may be or how it enters the room, provide an insulator that will tip up through the wall and arrange a "drip-bend" at the entrance. With a tipped-up insulator the worst driving storm cannot blow up and under into the room; whereas one that tips down may lead to a stream of water eventually running over the wall or floor.

At (1) and (2) we have optional methods for a safe anchorage of the aerial; see Fig. B above. The wrong way to bring the lead-in down is shown at (3); obvious, why didn't we think of it before? The connection at (4) will avoid lots of trouble.

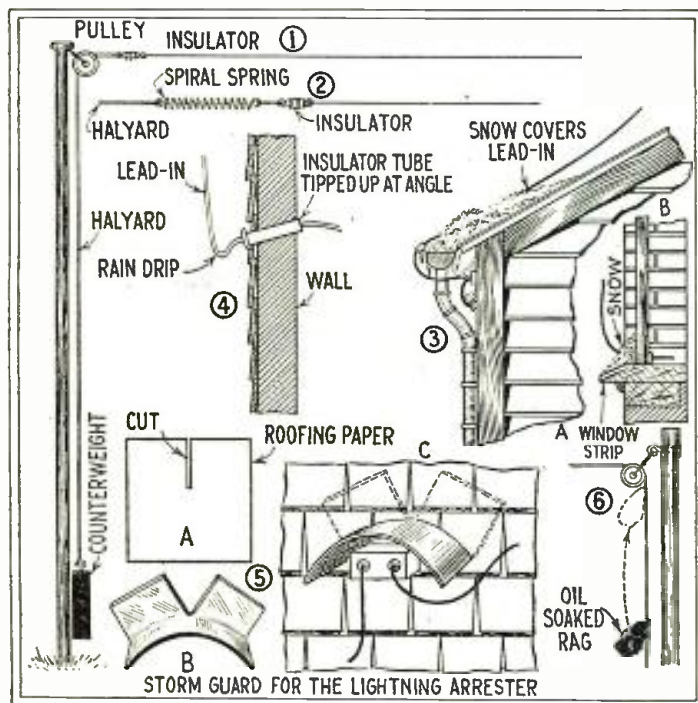

The diagrams at (5) show three stages of the manufacture of a serviceable storm-guard for the lightning arrester, which must be kept dry. The trick shown at (6) makes it possible to lubricate the aerial halyards conveniently. Prevention is always cheaper than repairs.

that all connections are clean and eliminate leaks and losses.

First of all, do not secure the outer end of the aerial to a tree if it can be helped. Trees naturally bend and lash in high wind and, unless some efficient compensating device is inserted, the aerial is sure to break. Of course, a big tree can be used with more or less success; but it is wise to have a stayed mast if possible. If a tree must be used, take up the backlash and the shrinkage with either a spiral spring in the halyard, between the pulley and the insulator, or a counterweight at the bottom of the halyard. Either is good but the writer prefers the counterweight; this can be composed of any old junk metal slightly heavier than the weight of the aerial, so that it keeps the latter taut, as shown in Fig. 1. Fig. 2 illustrates the spring method; the

away with splices, there are offsetting reasons why a splice may be the lesser of two evils. In winter a bare lead-in runs every chance of becoming imbedded in the snow or sleet deposited on a window-sill or in a crevice, and thus short-circuiting the signals to the ground. It happens many, many times that, when signals have died out during a snowstorm, it is later found that the lead-in has been grounded in some such way. Now, by having the lead-in of heavily insulated wire and soldered securely to the aerial, such grounding is made impossible.

The drip-bend in the lead also tends to allow all accumulated water on the lead to drop to the bottom of the loop and be blown off. This arrangement is shown in Fig. 4.

### SHORTS IN THE ARRESTOR

Watch your lightning arrester; it can cause much trouble-shooting because of a short between the contacts inside. This is especially true of arrestors with an open back or other way by which rain or melting snow can creep inside. If you hear a *click-click-click*—during the height of a rain, but no such sound during dry weather, you can make up your mind the lightning arrester is at fault. Even a sealed one can short with water across the terminals. A nice little hood is shown in Fig. 5 and can be quickly made from heavy roofing (Continued on page 490)

# Electrodynamic Speakers Become Popular



How This Reproducer Differs Electrically and Mechanically From Other Horns and Cones, and the Necessary Conditions of its Operation



By Fred H. Canfield

ANYONE who has made the slightest attempt to follow radio developments during the past year is aware of one outstanding trend which is the cause of considerable discussion at the present moment; namely, the greatly increased popularity of the electrodynamic speaker. Less than one year ago a majority of the broadcast listeners in the United States had never heard the term *electrodynamic* used in connection with a piece of radio apparatus, whereas today it is on the tip of every radio fan's tongue. Further evidence of the sudden change which has taken place in the loud-speaker field may be gained from the fact that last year at this time only three manufacturers were making electrodynamic reproducers, and today they are being sold by two-thirds (thirty-two) of the larger manufacturers of receivers and by twenty-one speaker manufacturers.

After giving the above statistics it is hardly necessary to explain that the electrodynamic loud speaker is a superior reproducer of radio music. It may be said that this loud speaker is capable of reproducing a radio program with less distortion than any other type available at the present time. Also, these speakers are able to handle great volume without overloading and without distortion. Those who are inclined to be skeptical of these claims are referred to accounts of the sound-transmission demonstrations conducted in New York City a few months ago under the auspices of the Bell

Telephone Laboratories (see RADIO NEWS for April, 1928). Electrodynamic speaker units were used for these transmissions, and listeners on the New Jersey shore of the Hudson River were able to hear clearly a voice which was projected from a giant horn installed atop a New York office building, three miles away. Of course, such performance cannot be expected from the usual speaker, but the experiment shows what may be accomplished with specially-built electrodynamic units. Also, it may be pointed out that such a feat has never been approached with electromagnetic speakers of the type usually used for radio reproduction.

### NOT A NEW INVENTION

The electrodynamic speaker is not a new invention, although the suddenness with which great numbers of these speakers have appeared on the market has caused many persons to consider it as such. The fact is that the electrodynamic principle has been known and thoroughly appreciated by engineers for a number of years, and at least one speaker of the type has been on the market since the early days of broadcasting. Also, it has been known that these speakers were capable of providing better results than the usual design of "electromagnetic" speakers. They have not been used generally because their construction is necessarily more elaborate and complicated than other types, and because the quality of reproduction obtainable from the average set in previous years did not warrant the



Fig. C

This picture shows an electrodynamic speaker cabinet of usual design. The grille, backed with a light cloth, conceals the opening for the cone, and the cabinet itself serves as a box-type baffle. The rear of the cabinet is open, but covered with a wire mesh.

use of a better speaker than those available.

Before continuing further with this article, the meaning of the term *electrodynamic*, when applied to a loud speaker, will be explained. In this connection it should be understood first that the word refers to the electrical principle upon which the speaker operates, and not to the construction. From this it may be seen that any of the popular types of speakers, such as the cones, horns, stretched-diaphragms, etc., may be electrodynamic or permanent-magnetic in principle; the only difference between the two being in the loud-speaker unit. It so happens that a large majority of the electrodynamic speakers on the market are of the free-edge cone type, because this is considered the most practical design for these speakers.

### WHAT THE DIFFERENCE IS

The chief difference between the permanent-magnet and electrodynamic speaker units is in the source of magnetic force. As the name indicates, the first type employs a permanent magnet to produce the necessary lines of magnetic force; but in the case of the electrodynamic speaker, an electromagnet is used for the same purpose. Electromagnets have many advantages over permanent magnets, but they require a source of direct current for their operation. These magnets consist of coils of many turns of wire wound over cores of soft iron. With magnets of this type it is possible to produce a field of great strength, such as is required for the reproduction of strong radio signals.

The second difference between the two types of speaker units is in the method of producing vibrations of the diaphragm. In

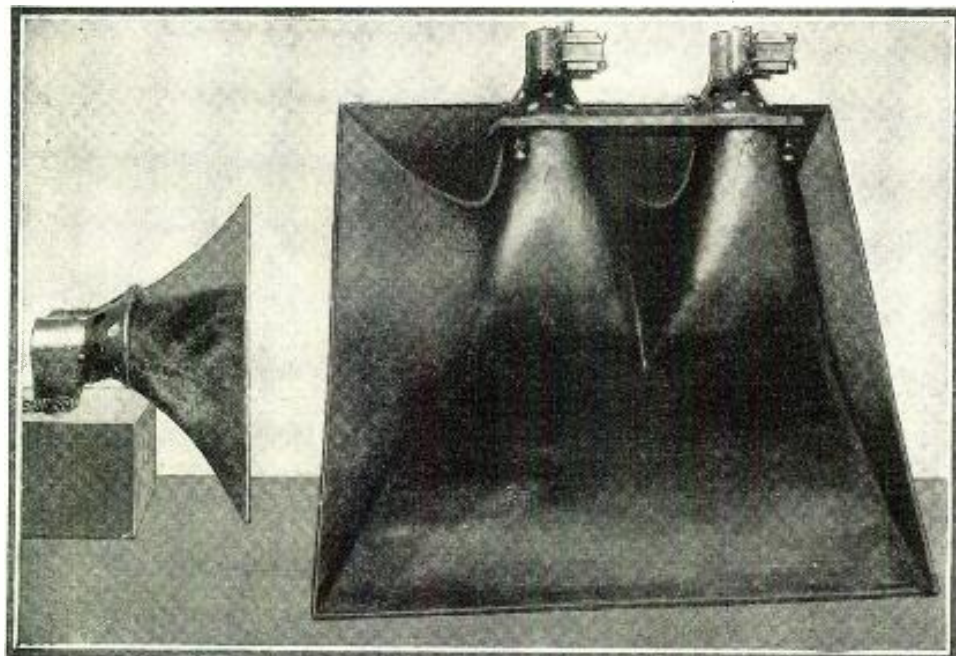

Fig. B

Two electrodynamic horn speakers are shown above; that to the left is a small cabinet-size exponential horn which has been designed for home use. The speaker at the right is a large double exponential horn intended for use in theaters, in connection with the presentation of talking moving-pictures. It is five by six feet in cross-section at the opening.



the permanent-magnet unit the modulated current from the radio receiver flows through coils wound over the magnet, and a diaphragm is located so that it is separated a fraction of an inch from the pole pieces of the magnet. The modulated current causes changes in the magnetic force and these cause the diaphragm to vibrate. On the other hand, in the electrodynamic speaker a moving coil is freely suspended in the field of the electromagnet, and this coil is fastened directly to a free-edge cone. The modulated current from the receiver

the small moving coil offers almost a pure resistance load to the tube. These three factors, combined, make it possible for the speaker to provide great volume without distortion, and allow the unit to provide uniform reproduction on all frequencies. In addition, the driving unit itself does not have a definite resonance frequency.

Another interesting feature of the electrodynamic speaker is that it will not weaken with use or ages; for there are no permanent magnets to become weak as they lose their magnetism.

APPLICATIONS OF THE UNIT

Early in this article it was stated that electrodynamic speaker units may be employed for the operation of any standard type of loud speaker, but that the free-edge cone speaker is now being used almost exclusively in connection with these units. The mechanical construction of a speaker of this type is shown in Fig. 6, and a picture of the unit is given in Fig. A.

In these illustrations it will be seen that the electrodynamic unit is much larger and heavier than the permanent-magnet type. The field winding consists of thousands of turns of wire wound over a solid-iron core; this coil is housed in a heavy cast-iron case at least four inches long and four inches in diameter. The frame for the cone is attached to one end of this case, at the end of which there is an opening for the moving coil. The paper cone is non-rigidly attached

Electrodynamic speaker units are made also for exponential horns. The electrical construction of these units is identical with that of the cone type, but the mechanical construction is changed somewhat. The frame for the cone and the cone itself are eliminated, and the moving coil is attached to a diaphragm. The picture, Fig. B, shows a large double exponential horn with two electrodynamic units attached. This horn has a bell five by six feet in cross section, and was designed for use in theaters in connection with talking moving pictures. However, electrodynamic units for use with smaller horn speakers are available.

A smaller speaker of this type, designed for use in a console cabinet, is also illustrated.

THREE TYPES OF SPEAKERS

Thus far in this article the various advantages of electrodynamic speakers have been considered. However, there are many interesting things regarding the operation of these speakers which must be explained. The first is supplying the current for the field winding, and the following paragraphs will describe the various systems which may be used.

The electrodynamic speakers on the market are of three general types, viz: those which require a high-potential supply for the field winding, those which require a low-potential supply, and those which obtain direct current for the field winding from an alternating-current supply. The latter type of speaker is merely plugged into a 110-volt A.C. light socket and a transformer and rectifier, built-in as part of the speaker, convert the A.C. into a low-voltage D.C. of the value required for the operation of the instrument. (See Fig. 3.) The first two types of speakers require an external source of direct current.

Speakers requiring a high-voltage supply may be operated with D.C. developed by a standard "B" power unit, and the field winding may be employed as an A.F. choke coil in the filter circuit at the same time, thus improving the operating characteristics of the power unit. There are several different ways of connecting the field winding in the power-supply circuit.

Practically all of the speakers having high-potential field windings require approximately 50 milliamperes at 110 volts. The selection of this value of current for

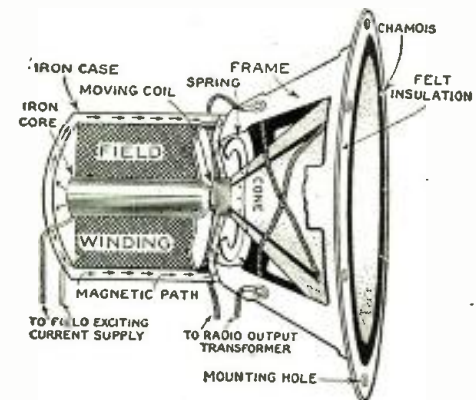

Fig. 6

The mechanical construction of an electrodynamic speaker unit for a free-edge cone is illustrated in this cut-away drawing. The paper cone, to which the moving coil is attached, is non-rigidly supported in position by a spring at the apex and a strip of chamois at the opening.

passes through this coil, causing it to move in its field with each pulsation; and as the free-edge cone is fastened directly to the coil, it vibrates and sets up the sound waves we hear as voice or music.

ADVANTAGES OF THE DYNAMIC

The outstanding electrical advantage of the electrodynamic speaker unit over other designs is found in the fact that the forces on the moving coil are dependent only upon the current in that coil. The magnetic field of the speaker is of great strength and the coil in the field has no effect upon the reproduction. Also, there is no iron armature to saturate. These facts result in complete freedom from distorting harmonies introduced by the speaker itself.

The mechanical construction of the electrodynamic speaker unit results in additional advantages. From the drawings it will be noticed that the motion of the moving coil is parallel to the pole pieces instead of between them; as a result, the danger of hitting the pole pieces is eliminated. Secondly, the usual driving rod, which is apt to bend and vibrate, has been eliminated by attaching the moving coil directly to the cone diaphragm; in this way another cause of distortion has been eliminated. Thirdly,

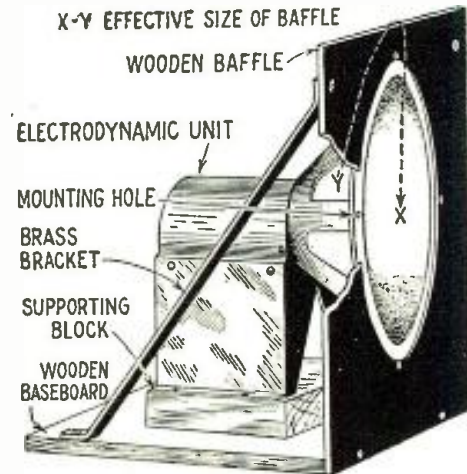

Fig. 4

This drawing shows the method usually employed in attaching an electrodynamic free-edge-cone speaker unit to a baffle of the flat type. The baffle board should be approximately three feet square, and the frame of the speaker should be securely fastened with wood screws to the baffle at the opening.

to the iron frame with a strip of chamois at the large end; at the apex a flexible spring holds it in position. Therefore, it may be seen that the cone is perfectly free to vibrate. The moving coil is attached to the apex of the cone, and this coil fits over the iron core of the magnet. Connection is made to the moving coil with flexible wires, as shown.

Two methods are provided for mounting the usual electrodynamic cone. A bracket is fastened to the case for mounting the unit on a baseboard; the input transformer of the speaker is usually mounted on this same bracket. Also, holes are drilled in the cone frame for fastening the baffle board rigidly in place. In addition, it will be noticed that the front of the frame is covered with a felt pad in order to insure an air-tight connection between the frame and the baffle.

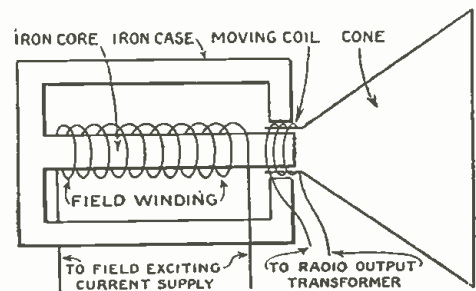

Fig. 5

This schematic diagram clearly illustrates the electrical design of an electrodynamic speaker.

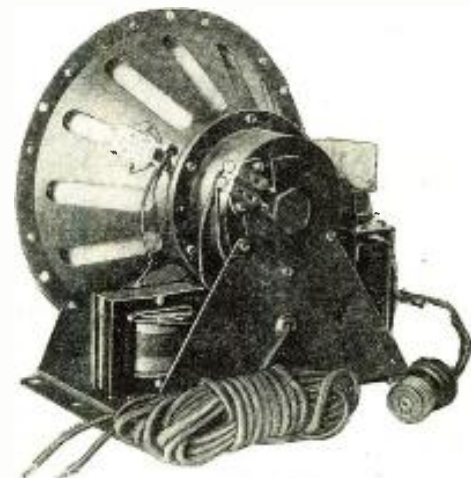

Fig. A

An A.C.-operated electrodynamic speaker unit of the free-edge-cone type is shown above. The instrument mounted on the left side of the base is the input transformer, and the parts at the right of the base are the step-down power transformer and the dry-electrolytic rectifier.

the field supply is very fortunate, as 110 volts corresponds to the usual drop in voltage across a choke coil in a "B" power unit, and the amount of current required by the average five- or six-tube receiver with a power tube in the last stage is about 50 milliamperes. Therefore, the field winding of the speaker may be substituted for one of the choke coils and no other adjustments are necessary. However, it is always wise to insert a milliammeter in series with the circuit to make sure that the speaker is receiving approximately the correct value of current.

In receivers which employ more than six tubes, and sets which have a push-pull power stage, the plate current is frequently greater than the current required by the loud-speaker field winding. When this is the case, the method described above cannot be used without danger of burning out the field coil. However, there is a very simple solution to the problem; the filter circuit of the power unit is not disturbed and the field winding of the loud speaker is connected after the two choke coils in series with the positive wire. The plate current of the power tubes does not pass through the field winding of the loud speaker, and also the plate current supplied to the low-potential tubes of the receiver receives additional filtering.

**COUPLING SPEAKER AND TUBE**

The second thing to consider in connection with operating electrodynamic speakers is the method of connecting the moving coil to the plate circuit of the last audio-amplifier tube. It should be explained that a step-down output transformer must be used, and the impedance of the secondary winding of this transformer must be matched to the impedance of the moving coil. The output transformer for these speakers is usually built into the speaker, but is sometimes supplied for external con-

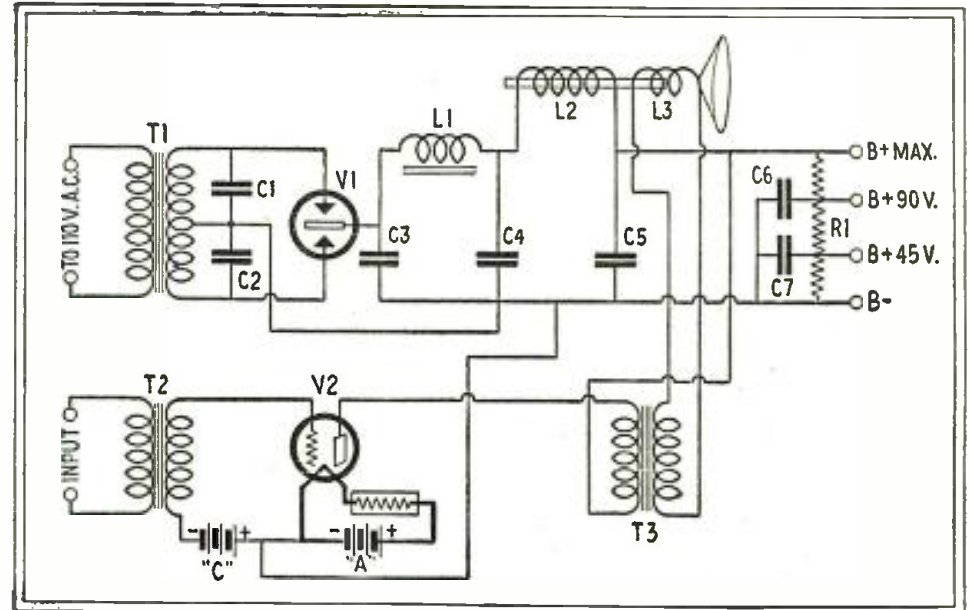

**Fig. 1**

*This diagram shows a combination "B" socket-power unit and last-stage A.F. amplifier, with the field winding of an electrodynamic speaker connected in place of one of the usual filter choke coils. When this arrangement is used the speaker receives field current, and the field winding acts also as a choke coil.*

nection. In either case this transformer must be used, and the regular output transformer or output filter in the receiver disconnected.

When it is desired to use an electrodynamic speaker in connection with a push-pull amplifier, another problem presents itself, as the output transformer supplied with the speaker is not of the push-pull type. The most satisfactory solution to this problem is to connect a center-tapped output impedance unit in shunt with the primary winding of the transformer, and to connect the two outside terminals of the impedance to the plates of the two tubes. Then, the high-voltage supply for the push-pull tubes is connected to the center-tap terminal of the output impedance. If desired, it is possible to insulate

the output transformer from the high-voltage supply by connecting a large by-pass condenser in each of the two wires from the primary of the transformer to the impedance unit. These condensers are not essential, but when the wires from the set to the speaker are exposed, they serve as a protection against accidental contact with the high voltage.

Fig. 1 shows the complete circuit of an electrodynamic speaker connected with a standard full-wave "B" power unit and a power amplifier using a single tube in the output circuit. T1 and V1 are the usual power transformer and the full-wave gaseous rectifier tube, with C1 and C2 buffer condensers having a capacity of 0.1-mf. L1 is a standard single filter choke; the field coil of the speaker (L2) replaces the second filter choke. The condensers, C3, C4 and C5, are the usual filter condensers, and C6 and C7 are 1-mf. by-pass condensers. In the amplifier circuit, T2 is a standard A.F. transformer, V1 is the power tube and T3 is the output transformer, which is supplied with the loud speaker. The output transformer, it will be noticed, is connected to L3, the moving coil of the loud speaker.

**OBTAINING PROPER FIELD CURRENT**

In arranging a circuit in this manner, it is important to make sure that the field winding of the speaker receives the proper current, and if the current in the circuit is insufficient, it will be necessary to change the characteristics of the voltage-dividing resistor, R1. For example, the instructions supplied with the speaker may state that a field current of from 40 to 70 milliamperes is required, and a milliammeter connected in series with the field winding may show that the current passing in the circuit is only 35 milliamperes. Under these conditions the speaker will not operate at maximum efficiency, and it will be necessary to use a voltage-dividing resistor of a lower total resistance. It is possible to correct this condition by connecting a resistor in shunt with the voltage divider or by redesigning the resistor, as described in an article entitled "Applying Ohm's Law to

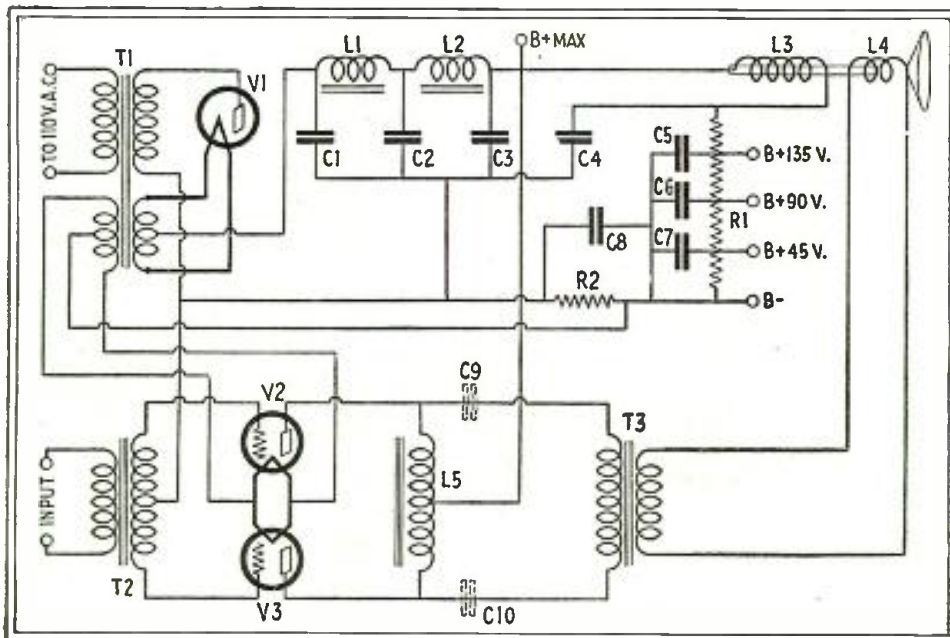

**Fig. 2**

*When the total plate current of a socket-power unit exceeds a certain value the circuit shown in Fig. 1 cannot be used for the operation of an electrodynamic speaker without danger of burning out the field winding. The above circuit provides a satisfactory solution to the problem, as the plate current for the power tube is tapped before it reaches the field winding.*

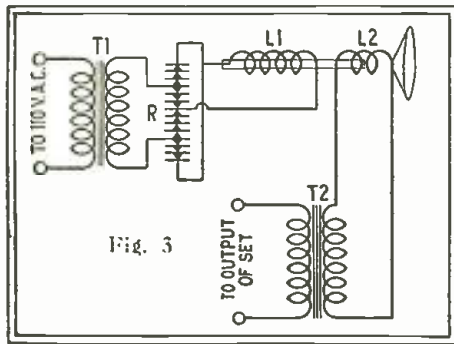

Fig. 3  
The socket-operated electrodynamic speaker uses a dry-electrolytic rectifier R to convert the stepped-down A.C. current into 6-volt direct current for the field winding L1. This arrangement may be used by the constructor with a speaker of the D.C. type, or a trickle charger may be employed.

Radio Apparatus," which was published on page 1348 of *RADIO NEWS* for June, 1928. However, in a great majority of cases it will be found that the current passing in the circuit will satisfy the requirements of the speaker.

Fig. 2 shows the method of connecting the speaker to a "B" power unit used in connection with a large set employing a push-pull amplifier. In this case the total current consumed by the set is so heavy that it would be apt to burn out the winding of the speaker, and, therefore, the plate current for power tubes is tapped before it reaches the speaker's field winding, which is connected as part of the voltage divider. In this circuit all the wiring and parts on the left side of the "B+Max." wire is standard, but on the right side of the line several changes have been made. Part of the voltage divider must be removed from the circuit to compensate for the drop in potential which takes place across the windings of the loud speaker, and probably the remainder of the voltage divider will have to be redesigned to permit a flow of current sufficient to operate the field winding of the speaker. For data on redesigning the voltage divider the reader is again referred to the article in the June number of *RADIO NEWS*. The circuit also shows the method of connecting the output circuit of the push-pull amplifier with the moving coil of the speaker. L5 is a standard center-tapped output impedance unit, and T3 is the output transformer of the speaker. The condensers C9 and C10 are not absolutely necessary, but, if used, should have a capacity of 2 to 4 mf.

With the low-potential electrodynamic speakers, the field coil is operated usually by a storage battery connected to the winding, but it is also possible to employ A.C. operation, as shown in Fig. 3. In this circuit T1 and R are a step-down transformer and a full-wave dry-electrolytic rectifier, respectively, which deliver direct current at 6 volts and  $\frac{1}{2}$  ampere. A standard trickle charger may be used to supply this current.

#### WHAT IS A BAFFLE?

The baffle is the next subject for consideration in connection with the operation of electrodynamic speakers. The baffle is a board on which the speaker is mounted; it is absolutely essential in order to obtain good reproduction from electrodynamic units of the free-edge cone type. In speakers of this type two distinct sets of sound waves are set up, one from the front and one from the rear of the cone. These sound waves will alternately neutralize and rein-

force each other if the proper precautions are not taken, and it is the baffle which prevents such interference. Also, the size of the baffle determines the lowest frequency which the speaker will reproduce with full volume.

Baffles are of two general types: the flat baffle and the box baffle. The two are equally effective, but the box-shaped baffle may be much smaller for equivalent results. The rule which applies in this case is that the lowest note which the speaker will reproduce at full volume is the one whose quarter wavelength is less than the distance from the front to the back of the cone around the edge of the baffle. Therefore, the baffle should be as large as conveniently possible, but considerable latitude is permissible.

To determine the wavelength of a note it is necessary to divide the speed of sound in air by the note's frequency. To find the wavelength of a 100-cycle note, for instance, it is necessary to divide 1120 feet (the speed of sound in air) by 100 cycles, and the result is 11.2 feet. As it is the quarter wave which is the important figure, it is next necessary to divide this figure by 4, and this gives us 2.8 feet, or 33.6 inches for the quarter wavelength of a 100-cycle note.

Provided a baffle is flat, there is no limit to its desirable size. Speakers have been inserted in the wall of a room, which is practically the equivalent of a baffle of infinite extent, with excellent results. However, under average conditions a 100-cycle baffle is entirely satisfactory, although better results could be obtained if it were still larger. A baffle of the flat type having a 100-cycle cut-off frequency will consist of a board approximately 35 inches square with a hole cut in the exact center for the cone.

#### BUILDING INTO A CABINET

In general, the box-type baffle is used more frequently than the flat type because it is more conservative in space requirements. As the effectiveness of a baffle is determined by the shortest air-wave distance between the front and back of the cone, it may be seen that a box baffle is the approximate equivalent of a flat baffle of much larger size. Therefore, the lower compartments of radio console cabinets often serve as very efficient baffles for electrodynamic speakers, as indicated in Fig. 7. One objection to the box baffle, however, is its tendency to resonate or "boom." If the box is shallow from front to back, though high and wide, this effect is not noticeable. If the box is deep from front to back, while small in its other dimensions, the effect will probably be objectionable. To overcome this trouble, holes should be bored in the sides, top or bottom; or the sides should be lined with felt, or other sound-absorbing material. In general, with a box less than 18 inches square and deeper than one foot from front to back, some precautions should be taken to prevent resonance. Any box, the back of which is not almost entirely open or which lacks some other outlet of equivalent size for the sound from the back surface of the cone, will resonate badly unless a great deal of felt is used. A grille, covered with a light cloth, is usually the equivalent of an opening for the purpose.

The remarks made above regarding the tendency of box baffles to resonate should not discourage the set builder from employing this type of construction. From a

practical viewpoint, the box baffle is much more satisfactory and, if it is properly designed, no trouble should be experienced. The size of the battery compartment of most radio cabinets is such that satisfactory results are assured. However, if it is desired to construct a 100-cycle box-type baffle, this should be approximately 16 inches square and 10 inches deep.

In constructing a baffle there are several things which should always be remembered. First, it should be made of heavy wood, so that it will not vibrate excessively on its own frequency. Secondly, the frame of the speaker should make an air-tight joint with the baffle at the opening which is cut for the cone. Thirdly, no holes should be cut in the front of the baffle other than the opening made for the cone. Lastly, the entire construction should be as rigid as possible.

When the speaker is located in the same cabinet as the receiving tubes, great care must be taken to prevent its vibrations from causing the microphonic sounds which so often ruin reproduction. For this reason, both the speaker and the receiver should be mounted on a sound-insulating material, such as soft rubber. Special brackets are sold for mounting speakers on a soft rubber cushion, and rubber pads may be placed under each corner of the sub-panel of the set to insulate it mechanically from the speaker. As an additional precaution, the sockets used in the set should be of the cushion type, and the tubes should be fitted with heavy ballast caps.

Very often, after unsuccessful attempts to eliminate microphonic noises, it is found that poorly-constructed apparatus used in the receiver is responsible. If it is suspected that the tubes are not the cause of the trouble the next parts to examine are the variable condensers. If condensers with unduly thin plates are used the vibrations set up in them may sound like tube noises in the speaker.



Fig. 7

A convenient method of mounting an electrodynamic speaker in a console cabinet is shown here. The lower part of the cabinet is thus converted into a baffle box, and the speaker should be so mounted that it comes in the exact center of its compartment. It should be provided with rubber feet to avoid vibration of the shelf on which the set rests.

# The Radio Beginner

## Some Facts About Transformers

By C. Walter Palmer

**A** TRANSFORMER is a device for transferring electrical energy from one alternating-current circuit to another, and for changing the voltage from one value to another. The usual transformer consists of two coils of wire wound on an iron or soft steel "core." The coil through which the current is supplied to the transformer is called the "primary," and the coil from which the electrical power is taken is called the "secondary." The alternating current traveling through the wire in the primary causes the iron core to become magnetized. This produces a varying magnetic field in the core, and because of the movement of this field, a corresponding voltage and electrical current is produced in the secondary by "electromagnetic induction."

It is necessary to use alternating or fluctuating current in a transformer. A steady direct current in the primary winding would magnetize the core and thus produce a magnetic field, but this field would be stationary and it is the movement of the field that induces the current in the secondary coil. Alternating current is continually changing, rising to a certain value, then falling to zero, rising in the opposite direction and reversing again. Because of this continually varying action, the magnetic field is also varying, and the form of the voltage induced in the secondary winding corresponds to that of the voltage in the primary. It is not absolutely necessary to have a primary current change its direction periodically, as alternating current does; it is only necessary to have its value change continually. A fluctuating direct current in the primary of a transformer will induce a fluctuating current in the secondary.

### URNS RATIO

The entire purpose of a transformer is to transfer energy from one circuit to another, and, if desired, to change the voltage of the secondary to a different value from that in the primary. The voltage across the secondary of a transformer is proportional to the ratio of the number of turns in the primary to the number in the secondary. If we have a transformer operating on a 100-volt supply and 500 turns of wire are used in the primary, a secondary containing 100 turns would have approximately 1/5 of the primary voltage, or 20 volts.

There are three general types of transformers. The first has equal primary and secondary windings, and the secondary voltage is the same as that impressed on the primary. The second type has a secondary smaller than the primary, and the secondary voltage is lower than that of the primary; this is a "step-down" transformer. The third type has a larger secondary than primary and the secondary voltage is higher than the primary; this is a "step-up" transformer. The exact value of the voltage in the secondary depends upon the turns ratio, as explained. See Fig. 1.

There is a slight loss of power in a transformer, for which there are a number of reasons. The windings present a certain resistance to the current, and some of the power is lost in overcoming this resistance. The core also presents a certain amount of heat loss, due to the currents which are set up in its laminations. The wire losses can be reduced by using heavy wire and the losses in the iron can be reduced by using a closed type of core.

### THREE TYPES OF CORES

As you will notice in the accompanying

illustration, Fig. 2, there are three general types of cores used for transformers. The first is the open-core type, which has the lowest efficiency of the three. The second is the closed-core type, which is used almost exclusively for small transformers. The windings on this type of transformer may be both on one arm of the core, as shown in Fig. 3; or the primary and secondary may be wound on opposite arms, as in Fig. 4. The third type of transformer is the shell type, with a completely closed core. This type of transformer is usually used when large currents are involved.

Fig. 2 also shows an auto-transformer. An auto-transformer contains a single winding, with a tap somewhere along it. In the step-up type, the total winding is used as the secondary and part of the same winding (from one end to the tap) is used for the primary. In a step-down auto-transformer, the tap is placed in such a position that the ratio of the total winding to the section supplies the correct ratio of primary and secondary turns, for the required secondary voltage. The entire winding is used as the primary, while the tapped section becomes the secondary. In a step-up auto-transformer, the tapped section is the primary and the entire winding the secondary.

### WHY THE LAMINATIONS?

In order to reduce the heat losses in the cores of transformers, they are almost invariably made of very thin sheets of iron, each one insulated electrically from the others. This arrangement prevents large induced currents from being set up in the core. In a closed-core transformer with a solid core, the core can be considered as a single turn secondary which would have a

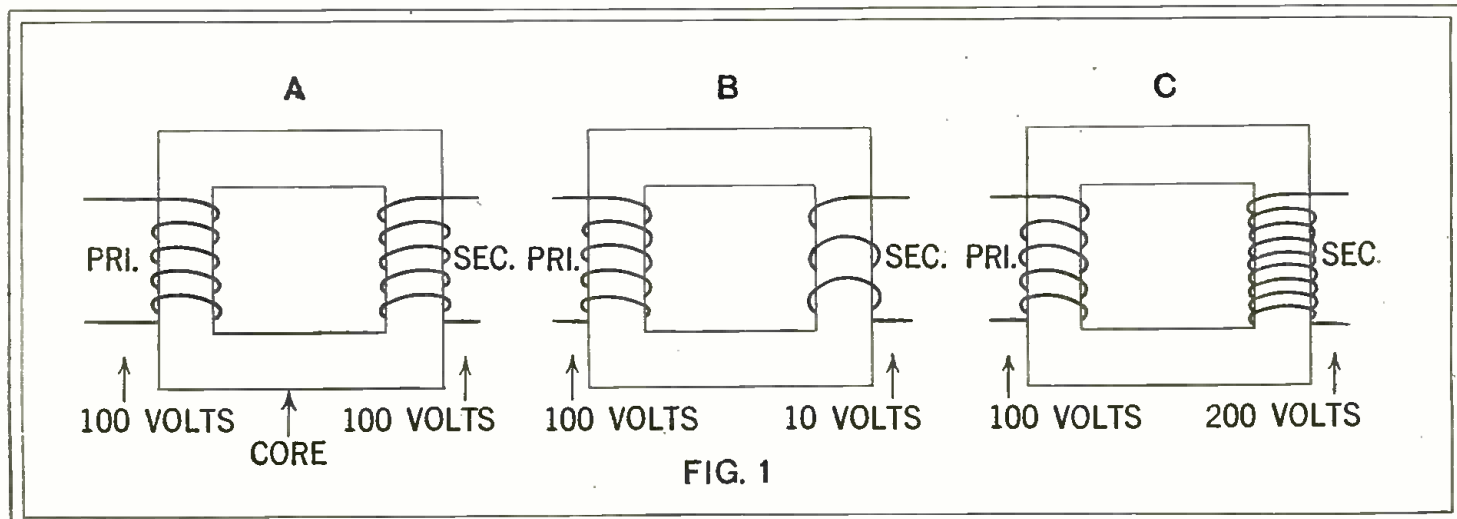
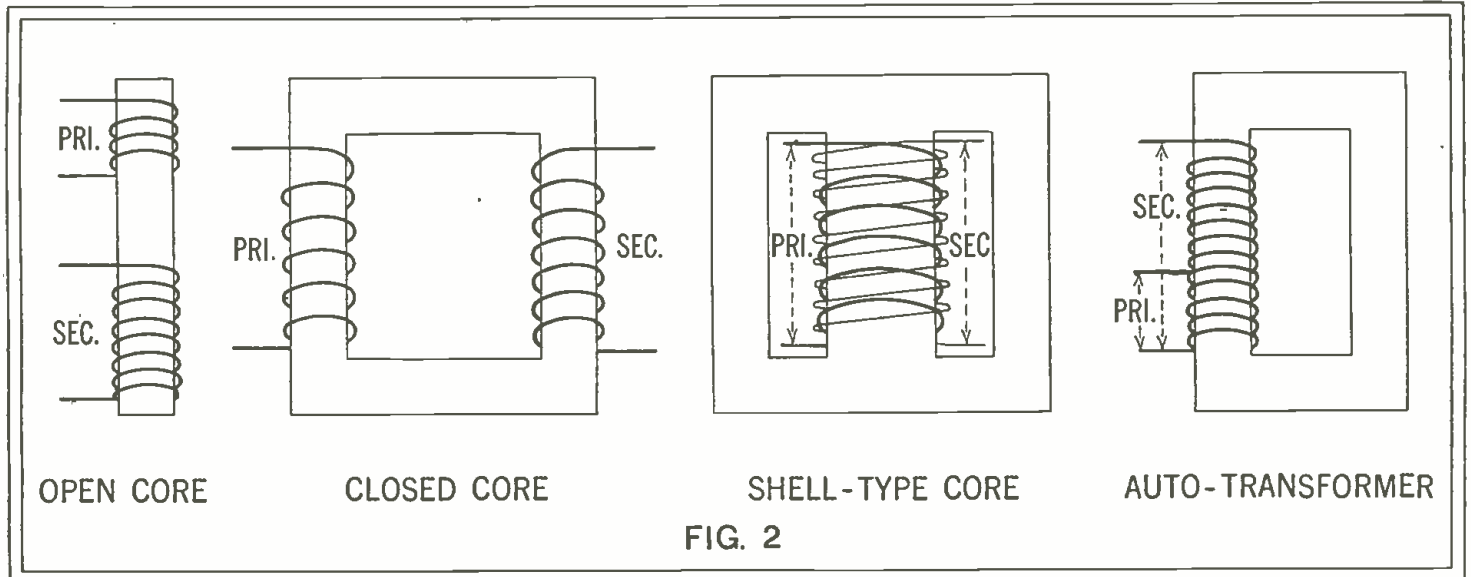

FIG. 1

Transformer A is of the 1:1 type; primary and secondary have an equal number of turns, and the secondary voltage is the same as the primary. Transformer B is of the "step-down" type; transformer C, of the "step-up" variety, depending on the "turns-ratio."



Above are shown the four general types of transformers. In the auto-transformer, if it is of the step-up kind, all of the single winding is the secondary and part of it the primary. If of the step-down

type, the whole winding is the primary and the tapped portion the secondary. In the shell-type transformer, both the primary and secondary are wound on the center section of the core.

very low voltage but high current-capacity characteristic. Naturally, the current flowing around the closed ring would cause a lot of heat and a corresponding loss of useful current. These currents are called "eddy" currents. In transformers using laminated cores, they are broken up into small sections in each lamination, and since the laminations are insulated, the heat losses are reduced considerably.

An interesting fact about transformers is that when the secondary circuit is opened, very little current flows in the primary. This is due to the fact that the value of the magnetic current set up in the core is gradually increased when no current is drawn from the secondary. This magnetic current reacts on the primary and produces another voltage in the latter which is just opposite to the original current impressed upon this winding. This additional voltage increases in value until it stops all of the current from the supply line, except just enough to produce a magnetic field sufficient to maintain the opposite voltage. Therefore, a transformer connected to a supply line and having its secondary open will draw an exceedingly small amount of current.

The transformers employed in radio can be divided into two general classes: those supplying filament current and plate voltage to the tubes, and those used in audio-frequency amplifiers for transferring the

radio signals from one stage to another.

POWER TRANSFORMERS

Power transformers are heavily constructed with large cores and heavy wire, since relatively large currents are passed through them. Most commercial transformers are placed in metal boxes and a number of models are sealed in wax or other compounds, to "damp" core vibration.

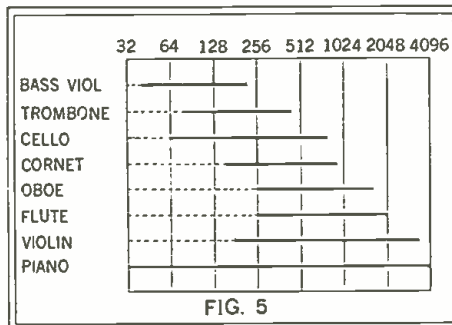

This chart shows the range of frequencies covered by the common musical instruments.

In very large power transformers, the windings and cores are exposed to a current of cold air or they are immersed in oil or water to keep them cool. However, in transformers designed for ordinary radio receiving work, this is not necessary, since the devices are small and excessive heating can be avoided by their natural exposure to the air.

There are two general types of radio power transformers. The first is of the step-down type, having a much smaller secondary winding than primary. These are used for lighting the filaments of alternating-current tubes and the tubes used in power amplifier circuits. They are constructed with large cores and heavy windings, so that a large current can be drawn from them. There are available a number of these transformers, which operate from the 110-volt, 60-cycle electric light line and produce the low voltages required for the filaments of the 226, 227, 171 or 112 and 210 tubes. The voltages required are 1.5, 2.5, 5 and 7.5, respectively. The 1.5- and 2.5-volt windings are usually designed to supply comparatively large currents—seven or eight amperes—since the A.C. tubes have

a high current drain. The last two windings are usually designed to supply 1 to 2 amperes, since they are used for one or two power tubes.

The second type of power transformer supplies the high voltage required for the plates of vacuum tubes in a radio set, and is used in "B" socket-power units. This type of transformer has a secondary winding with a large number of turns of rather thin wire, since only a small amount of current is required. These transformers are wound with either a single secondary winding for a single rectifying element, or with a center-tapped secondary for the full-wave type of rectifier. The difference between these two systems is that in the half-wave type, only half of the A.C. cycle is usefully employed. When the current is traveling in the opposite direction, it is not used, but is merely stopped by the rectifier. This type of transformer and rectifier supplies a fluctuating direct current, and a very efficient filter system must be used to smooth it out into the steady current required for the "B" supply. The other type of rectifier (full-wave) operates on both halves of the cycle, and produces a steadier current which requires less filtering or ironing out.

THE VOLTAGE VALUES

Transformers for "B" power units are arranged to supply different voltages for the different systems employed. The most common type has a full-wave secondary and supplies about 225 volts in each sec-

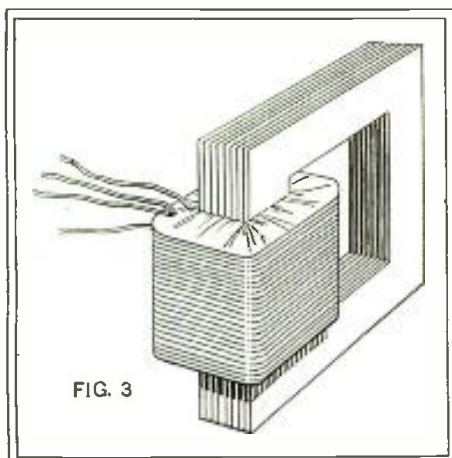

In this model of the closed-core transformer, primary and secondary are wound on one leg of the core.

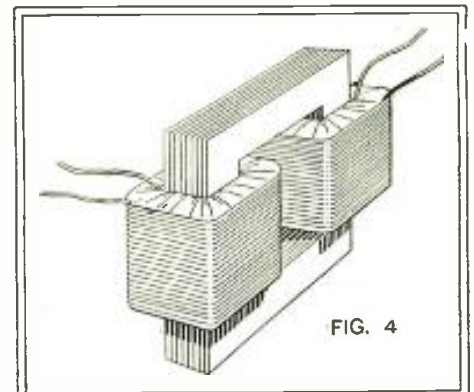

In this model the primary and secondary are wound on opposite legs of the core.

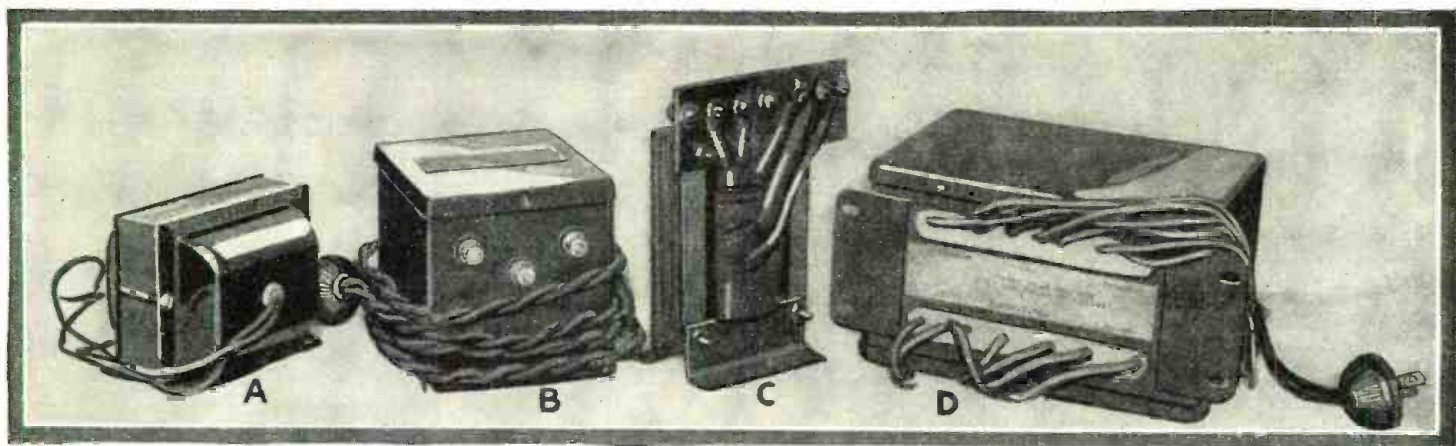

Four commercial transformers sold for radio use. A, B and C are filament-lighting transformers, which step down the 110-volt, 60-cycle alternating house current to values between 1 and 15 volts. D is a combination unit which furnishes "B" voltage as well as filament current. Transformers are also available, which supply both filament and plate current, with one core.

tion, or 450 volts maximum. This transformer is used with the filament type or gaseous-content type rectifying tubes to supply the plate current to the 171- and 112-types, as well as to the other tubes in the set.

The other common type supplies current at about 500 volts and is of either the half- or full-wave type. This transformer is used with the filament type of rectifier tubes to supply plate current to the 210 and 250 power tubes. The current required from the secondaries of these transformers depends upon the type of rectifier tube employed, and the amount of current necessary for the receiver. It usually varies between 60 and 150 milliamperes. This is a rather small current, since a milliamper is one-thousandth of an ampere.

Besides these two general types of transformers and the variations of each type, there are several combination transformers now being sold. These transformers have both large and small secondary windings, so that the filament and plate supply can be obtained from a single unit. A number of these transformers are wound with high-voltage, full-wave windings and either center-tapped or untapped windings to supply filament current.

**AUDIO-FREQUENCY TRANSFORMERS**

The problem of designing good audio-frequency amplifying transformers is very different from that of designing power transformers. In the latter, currents at only one frequency have to be considered, and the windings and core can easily be arranged to give the greatest efficiency at this figure. However, in amplifying transformers, a very wide band of frequencies must be covered with uniform efficiency, so that the signals and music will not be distorted.

By referring to the chart of frequencies covered by common musical instruments that will be found on the preceding page, it will be seen that an average broadcast transmission covers a band between 30 and 5,000 cycles. An ideal transformer should transfer currents of any frequency in this band equally well.

Transformers for audio-frequency amplifying circuits can be divided into four types; the ordinary

step-up, push-pull, auto-transformer and output. The problems involved in each of these types are approximately the same and a general discussion of these problems will be worth while.

The purpose of the transformer used as a coupling device between two vacuum tubes in an amplifier is to receive the current changes from the preceding tube and

deliver them to the following tube with an increase in voltage. However, the comparative voltage changes on the different signals must all be the same, so that natural reproduction will result.

If the primary of the transformer is too small (if it has too low an impedance), the lower frequencies will pass through without affecting the secondary. The low impedance does not allow the current to magnetize the core or transfer the energy to the secondary, and the low frequencies are by-passed through the primary winding. It has been found that the primary impedance should be two or three times the tube output resistance in order to fully amplify the lower notes.

**OBTAINING CORRECT IMPEDANCE**

In order to obtain the correct primary impedance, it is better to use a large core rather than increase the number of turns in the primary. If a small core is used, the primary must contain a great number of turns and naturally this also means an unusually large secondary coil in order to get the step-up ratio between the two coils. The use of a very large secondary will also have a bad effect, since it has a tendency to increase the capacity between the turns of wire in the secondary. This value is known as the distributed capacity, and when it is increased, the higher frequencies are by-passed by it and are not properly amplified.

It is generally considered that, the larger the core of a transformer, the more uniformly it will tend to amplify both the high and low frequencies. The core must be made of special magnetic material with a high magnetic value, or permeability.

There are two currents flowing through an audio-frequency transformer. The first is the alternating current which constitutes the signal and the other is the direct current of the "B" supply. In a transformer with a small core, these two currents together may be sufficient to saturate the iron. In other words, the core is not large enough to handle all of the magnetic field produced by the primary winding. This condition may cause the production of harmonics of frequencies which

(Continued on page 486)

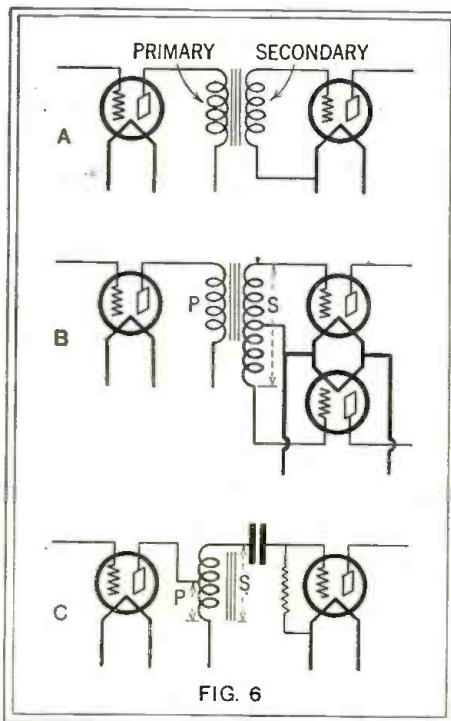
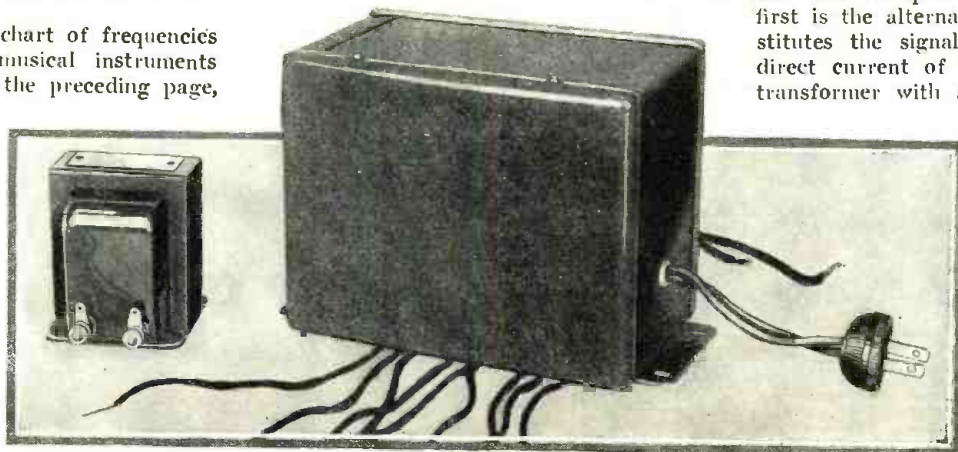

FIG. 6

Above: A, standard step-up transformer amplifier circuit. B, push-pull hook-up. C, auto-transformer arrangement.

Below: An amplifying transformer (left) compared in size with a "B" supply transformer.





**SHOULD BE GOOD**



**SERVICE MAN** (after listening to local interference in receiver): "I am afraid, madam, that it is your location which is to blame. The set is working all right."

**OWNER** (justly indignant): "I'll have you know, young man, I have as good a location as anyone in this town. I pay \$80 a month rent here!"—*S. O. Taylor.*

**LOOKED LIKE PHONES**

It was so cold that day that the traffic cop stationed at the school corner had to wear muffs over his ears. But he was slightly surprised when one little tad stopped to look at him carefully and then came up close and inquired, confidentially: "Say, mister, what station are you getting now?"—*Mollie Zacharias.*



**NEED ANY ASSISTANTS?**



**WIFE** (awakening her husband): "The early morning radio setting-up exercises are on! You left the radio turned on when you went to bed!"

**TIRED DX FAN** (after a hard night): "Please be quiet. I'm doing my daily dozin'."—*A. H. Rodiek.*

**HIS DX WAS NB (NEAR-BY)**

**FIRST RADIO FAN:** "What sort of a set has Joe got?"

**SECONN DITTO:** "Well, you don't need a radio log with his receiver. All you need is a splinter."—*A. H. Rodiek.*

**COUNT 'EM AND SEE**

**CITY BOARDER** (watching Farmer Timothy milk the cow): "Oh, yes, that set has four tubes, hasn't it?"



**RUNNING DOWN HIS BATTERIES**



**JUNIOR FAN** (entering hastily from outdoors at night): "O papa! The cat's tubes are lit! I saw his panel lights!"—*Philip Tracy.*

**EDISON'S GREAT RIVAL**

**CASEY:** "My static eliminator was invented by an Irishman!"

**JONES:** "What was his name?"

**CASEY:** "Pat Pending."

—*Billy R. Meredith.*

**NO KEYHOLE WORK**



**RADIO SALESMAN:** "Good morning, madam. With this fine six-tube radio you can listen in on what all the world is doing."

**COLORED PROSPECT:** "No, sah, ah believes in minding mah own business, sah!"

—*Wilfred Anderson (Bermuda).*

**CHEAP ENOUGH**

A resident of Melbourne recently had a radio set installed, and when his bill was presented this astonishing item was at the end of the account: "For hanging aerial and myself—22 shillings."—*Arthur Russell (Australia).*



**THIS** page is devoted to humor of purely radio interest; and our readers are invited to contribute pointed and snappy jokes—no long-winded compositions—of an original nature. For each one of this nature accepted and printed, \$1.00 will be paid. Each must deal with radio in some of its phases. Actual humorous occurrences, preferably in broadcasting, will be preferred. Address Broadcastatics, care RADIO NEWS, 230 Fifth Avenue, New York City.

**PUSHING THE SCOTCH TOO FAR**

What is the difference between a storage battery and a native of Aberdeen?

The storage battery can be overcharged! —From *The Savoley* (house organ of the British Broadcasting Co.)

**SHADOWED TO HIS DOOM**

**FAN No. 1:** "Say, why are you so interested in getting a television set working?"

**FAN No. 2:** "I want to see what Old Man Static looks like, so I'll know him. Then I'll get him and get him good, too!"

—*George Jess.*

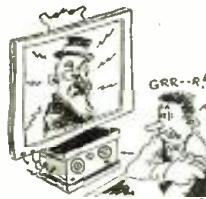

**THE LOST ART**

A local (Providence) station ended a morning talk for housewives with the promise of a free cook-book to those listeners who would call at certain chain stores. One young housewife who had purchased baked beans, salmon, condensed milk, canned tomatoes, etc., inquired as an afterthought for the cook-book offered by radio. "Lady," said the clerk, thoughtfully, "you don't want a cook-book; just a can-opener."—*Theodore A. Monahan.*



**RADIO RHYMES**



THERE'S JUST ONE THING I'D LIKE TO KNOW THAT'S QUEER TO ME IN RADIO—



I WONDER WHY EACH TUNEFUL STRAIN LIKE ANESTHETIC DRUGS THE BRAIN!—



THEN O'ER YOU DROWSY FEELINGS CREEP, AND LULL YOU TO PROFOUNDEST SLEEP.



NO DOUBT THE SCIENTISTS WILL CLAIM THOSE **ETHER WAVES** MUST BE TO BLAME!

# How to Construct the "Pre-Selector"★

A Receiver Accessory Which Provides Extreme Selectivity Without Loss of Sensitivity or Additional Controls

By S. Gordon Taylor

**T**HERE has always been a strong demand for an accessory that could be connected to any standard radio receiver to improve its selectivity. In general, such devices have fallen into one of two classes. The first is the well-known wavetrap, by means of which a single interfering station may be trapped out, either partially or completely; the second class includes what amounts to an additional stage of radio-frequency amplification built as a separate unit and connected ahead of the receiver.

Both of these accessories have the disadvantage of adding one or more tuning controls and both, therefore, tend to complicate the operation of a receiver. They have also individual faults. The wavetrap, for instance, is not always capable of entirely cutting out even the single interfering station for which it is adjusted and, furthermore, it frequently reduces the intensity or volume of the desired signals. The added stage of R.F. amplification almost always tends to make the receiver unstable by increasing undesirable feedback. To prevent oscillation in such a combination it is usually necessary to turn back the volume control, or the sensitivity control of the receiver, with the result that the over-all sensitivity of the combination is often actually less than that of the receiver alone. Most radio experimenters have tried devices of both kinds and have recollections of these facts.

**SOLVING THE PROBLEM**

In spite of these faults, there are thousands upon thousands of these two classes of accessories in use today. Such being the case, it seemed well worth while to devote some attention to the development of a unit that would really provide the maximum practical degree of selectivity but which—

- (1) Would not decrease volume or signal strength;
- (2) Would not complicate tuning or operation;
- (3) Would not tend to make the receiver unstable, and,

**Fig. C**  
The "Pre-Selector" has an attractive appearance; its controls supersede entirely those of the receiving set, which may be placed elsewhere.

- (4) Would be applicable to the general run of receivers in use today.

It was decided that these conditions could not be met without providing some degree

of amplification in the accessory unit to make up for the losses which are bound to result from any method that might be used to increase selectivity; this meant that at least one tube would have to be included in the unit. Furthermore, either the receiver or the unit would have to be untuned if we were to avoid adding tuning controls. Finally, the tube circuit or circuits in the unit could not be tuned to the same frequency as those in the receiver because the

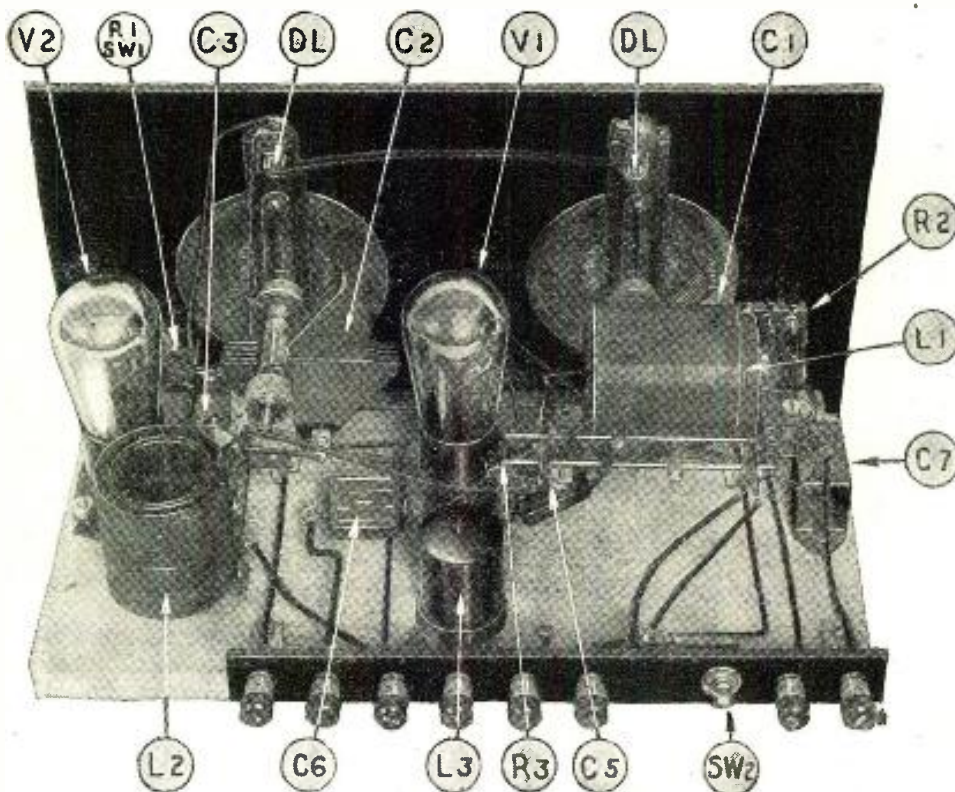
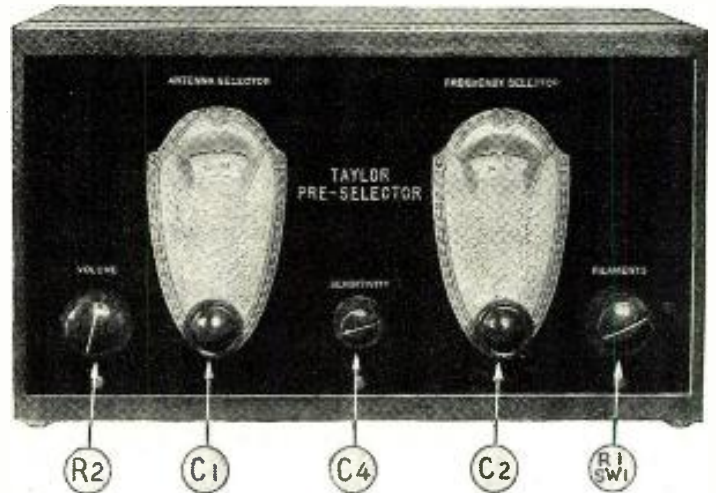

**Fig. B**

The aerial coupling of L1 is automatically varied with the wavelength by the movement of C1, which tunes the first-detector input. L2 comprises the oscillator coils and coupler.

addition of a resonant tube circuit would upset the stability of the receiver.

In the face of all these requirements, it became obvious that the only possible method of securing the desired results would be through the use of a heterodyne system. An experimental unit which included a "first detector" and oscillator was, therefore, built up. With this arrangement, the tuning controls of the receiver proper could be set at one wavelength and left there at all times, and the new unit would act as a frequency-converter to alter the frequency of any incoming signal to the frequency (wavelength) to which the receiver was tuned. The wavelength selected for the receiver was one just above the broadcast band, 560 meters to be exact. This scheme worked out admirably as far as selectivity is concerned. It also simplified operation, because all tuning is accomplished with the two controls of the unit instead of the three controls of the receiver proper. The combined outfit is also stable—even more stable than the receiver alone, because the receiver is now permanently tuned to such a high wavelength.

**IMPROVING THE DESIGN**

The only drawback found in this experimental unit was that it did not provide quite as great over-all sensitivity as with the receiver alone. Further experimental work was carried on, therefore, to overcome this objection. First, by increasing the antenna coupling in the unit, greater input-signal voltage was obtained and this has the same

\* RADIO NEWS Free Blueprint Article, No. 68.



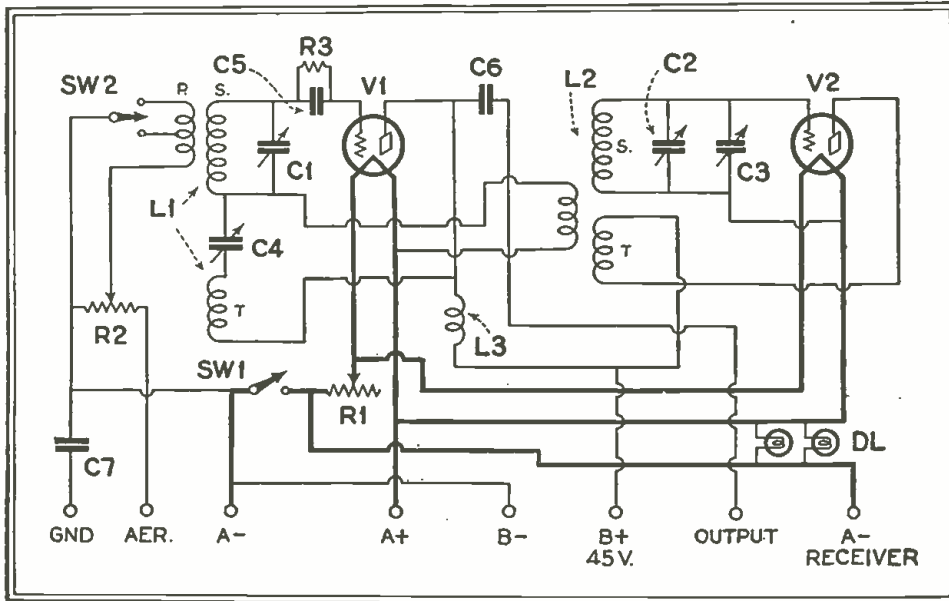

**Fig. 1**

The schematic diagram of the "Pre-Selector," above, shows it to be actually the frequency-changing end of a superheterodyne, for whose amplifier any tuned-R.F. set may be used. The first detector is regenerative.

effect as would increased amplification. Then regeneration was added to the circuit of the "first detector." These two changes both increased the pickup, and increased amplification was obtained. Thus the last requirement was more than satisfied.

Next, a good deal of time and effort was spent in further refining the device. It was found, for instance, that when the input circuit of the unit was tuned to certain wavelengths the unit did not function as efficiently as at others. Also, under certain conditions, the tuning of one dial tended to alter the setting of the other. It was decided, therefore, that variable coupling between the antenna and the unit is necessary and the coupling coil was redesigned to provide automatically variable coupling. This arrangement consists of gearing the primary of the antenna coil to the shaft of the tuning condenser; so that the antenna coupling increases and decreases as the condenser is tuned for high and low waves, respectively. Careful design of the oscillator pick-up coil also helped to improve the results.

The next refinement consists of a switch which is incorporated in the unit for the purpose of turning a receiver's filaments off and on, together with the filaments of the two tubes in the unit itself. For this purpose a combination rheostat and switch is included in the unit. The former controls the filaments of the two tubes and, when it is turned off, opens the switch which controls the receiver filaments.

**REMOTE-CONTROL APPLICATION**

A very important possibility, and one which had not been thought of in the beginning, was that of employing this unit as a remote-control device. Inasmuch as the input frequency is changed during its progress through the unit, there should be little chance for feedback from the output to the input (aerial) lead. Therefore, there is no good reason why the unit cannot be placed some distance from the receiver. Experiment proved this theory to be correct and no difficulty was encountered in operating a receiver in the next room, approximately 20 feet away from the aerial lead and the new unit. This experiment brought up another requirement--that of controlling the

volume at the unit rather than at the receiver; a special high-resistance potentiometer was therefore included in the antenna circuit. Thus, not only the tuning and all filaments, but also the volume, were entirely controlled without going near the receiver proper.

Finally, the unit was considered deserving of a name and it was informally christened the "Pre-Selector."

The Pre-Selector has been tried out with a great many receivers, both commercial and home built. Of all which were tried, the only sets with which it did not perform in the usual manner were certain superheterodynes and some receivers which employ only a regenerative detector and audio amplification. In every case where the receiver employed one or more stages of tuned R.F. amplification, the results were excellent.

With receivers which employ a regenerative detector without R.F. amplification preceding, the Pre-Selector changes the input characteristics of the regenerative circuit sufficiently to prevent proper regeneration. In some superheterodyne receivers the double-heterodyne action will result in harmonics and "birdie" whistles. This is not true of all superheterodynes; because in some cases the Pre-Selector has been found just as satisfactory with receivers of this type as with tuned R.F. outfits.

**HOW THE PRE-SELECTOR FUNCTIONS**

The Pre-Selector is connected between the aerial and the "Acr." binding post of the receiver with which it is to be used, and the tuning controls of the receiver are adjusted to resonance at any wavelength above the broadcast band; usually around 560 meters, for this is as high as most standard receivers will tune. The Pre-Selector may be connected to the batteries employed by the receiver or may have its own set of batteries, whichever is more convenient; more will be said about this later.

The left dial of the Pre-Selector is the wavelength or tuning adjustment; it controls the variable condenser C1 which tunes the secondary of the antenna coupler L1 in the input circuit of the first tube V1. This coupler includes a center-tapped primary winding mounted on a movable carriage which, in turn, is geared to the rear end of the shaft of condenser C1 by means of the cam-and-pin arrangement, supplied with the coupler. Thus, the primary coil is moved in and out of the secondary coil to vary the coupling according to the wavelength to which the circuit is tuned.

In series with this secondary winding of the antenna coupler is the small pick-up coil which constitutes part P of the oscillator coil, L2. By means of this pick-up coil part of the oscillator energy is impressed upon the detector grid circuit along with the incoming signal from the broadcast station that has been tuned in.

The detector combines these two frequencies to form a third, which is equal to

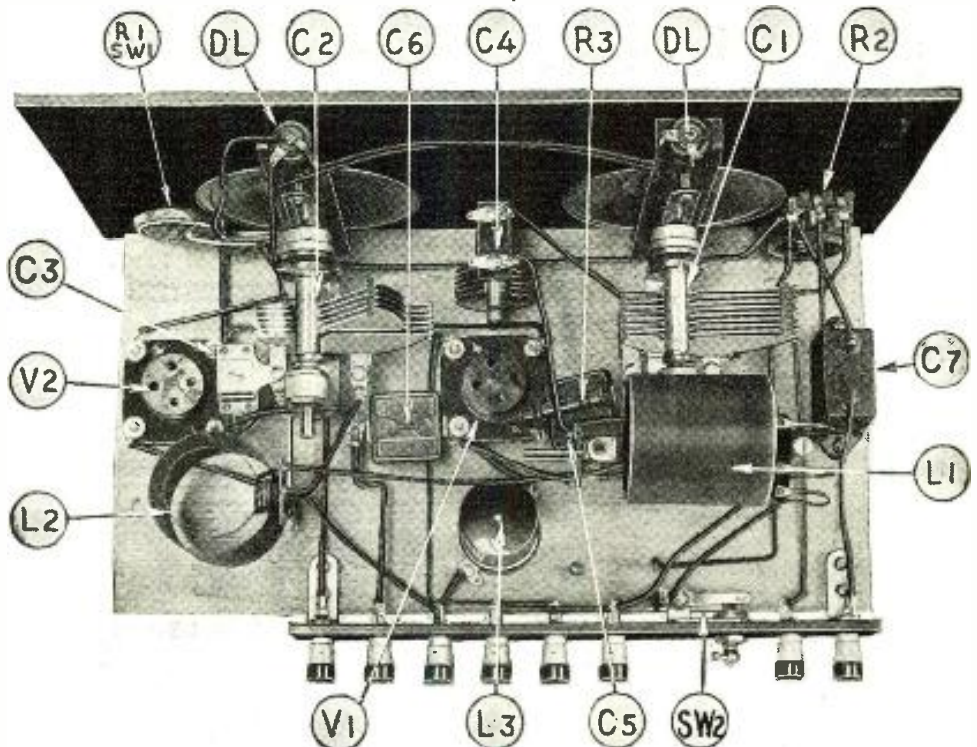

**Fig. A**

This view from above shows how direct are the leads employed in wiring the Pre-Selector. All wires are run above the wooden baseboard. Two methods of connecting to batteries appear in Figs. 2 and 3.

the difference between the two frequencies present in the grid circuit. By tuning the oscillator circuit this third frequency may be made equal to that, say 535 kilocycles (560 meters), to which the receiver proper has been tuned previously and the signal from the broadcast station will be amplified in the receiver and heard in the loud speaker.

From the foregoing explanation it is apparent that an installation, which includes a tuned-R.F. receiver and the Pre-Selector, really amounts to a superheterodyne receiver; in which the Pre-Selector functions as the so-called "first detector" and oscillator, while the R.F. amplifier of the receiver proper serves as the intermediate amplifier of the combination.

**FEATURES OF THE CIRCUIT**

The tremendous selectivity afforded by the Pre-Selector is due largely to the frequency-changing process involved. In addition, the Pre-Selector combination provides better selectivity than the average superheterodyne receiver; because the R.F. amplifier of even a very broad-tuning broadcast receiver is tuned much more sharply than are the coupling transformers ordinarily employed in the intermediate stages of a regular superheterodyne receiver.

Regeneration in the detector circuit of the Pre-Selector is not required for the sake of selectivity, but is used solely for

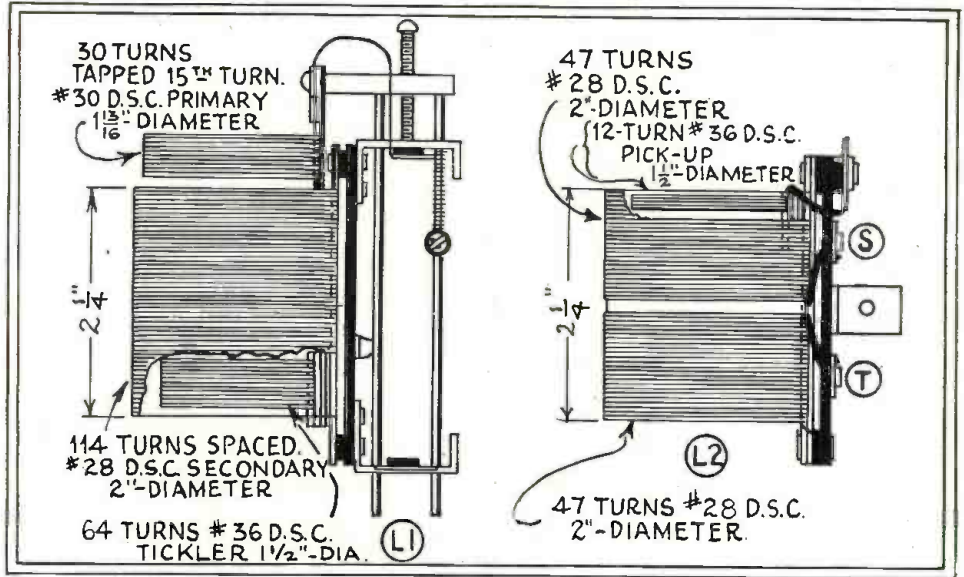
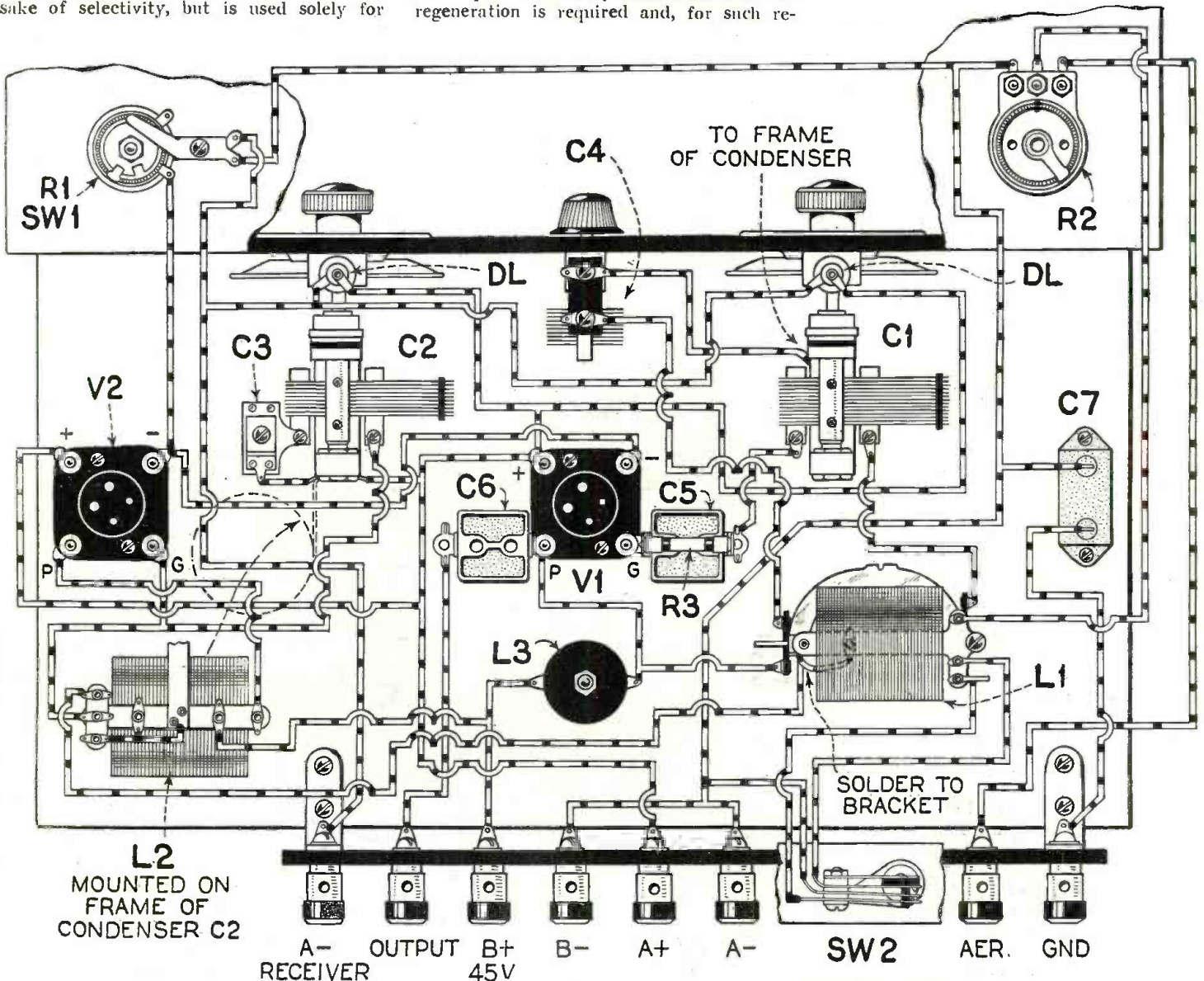

**Fig. 4**

Details of the coils; the primary of L1 is mounted on a slide, which is moved out of the secondary by a cam on the tuning condenser C1 as the rotor plates rise.

the amplification it provides. Ordinarily the regeneration control, C4, is left with its knob set at zero. It is only in the case of reception from very distant stations that regeneration is required and, for such re-

ception, the knob is turned up to a point just below that at which the detector goes into oscillation. The regeneration is ob-



**Fig. 5**

Complete wiring layout of the "Pre-Selector," the apparatus is slightly spread apart in the picture to show the connections.

COIL L1 MOUNTED ON FRAME OF CONDENSER C1

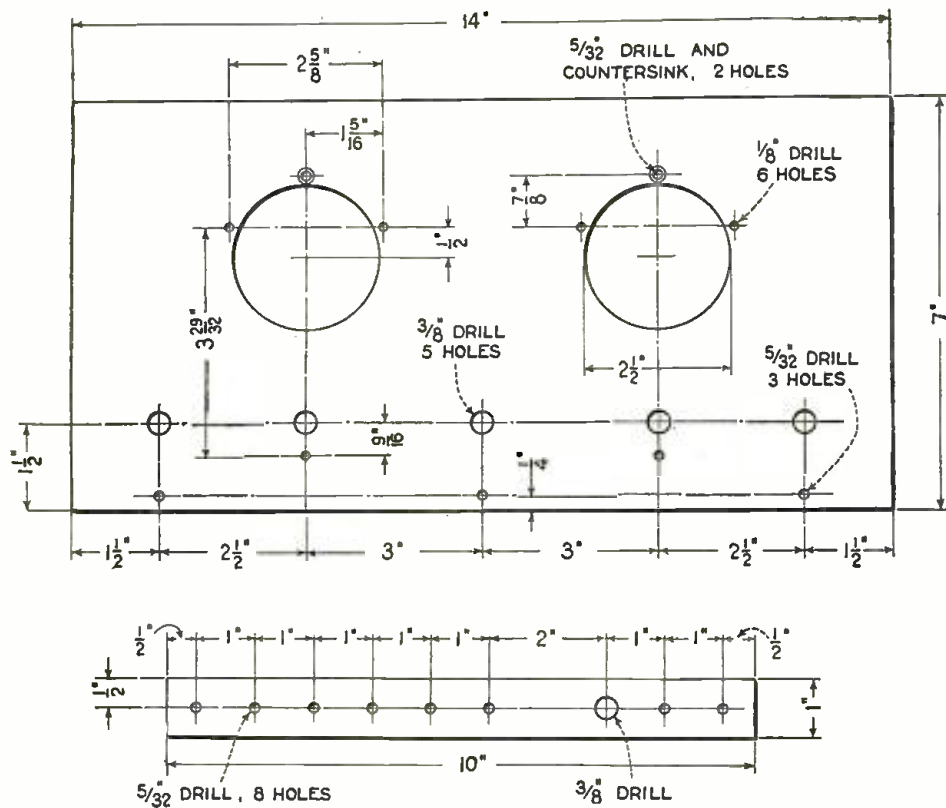

Fig. 6

Drilling details of the "Pre-Selector" panel and binding-post strip.

tained through the use of a feed-back coil mounted in a fixed position inside of the secondary of the input coupler, L1.

It will be noted from the diagram, Fig. 1, that a switch, SW2, has been included in the ground side of the antenna circuit. This switch is required, not for its effect on selectivity but rather to permit the smooth and consistent control of regeneration. Where a very large antenna is employed, with the full primary winding in the circuit, the absorption effect is so great as to make regeneration ineffective. In such a case the switch is set so that only half of the winding is in the antenna circuit, thus reducing the absorption effect to overcome this difficulty.

The by-pass condenser C7 has been included in the ground circuit of the Pre-Selector, simply as a safety measure, to prevent any possibility of short-circuiting the "A" current in cases where the same device is used to provide the filament current for both the Pre-Selector and the receiver.

The only other circuit feature not covered is that which employs the small adjustable condenser, C3. The purpose of this condenser is to permit enough capacity to be

**No. 68**

A set of large blueprints and a list of parts used in the construction of the "Pre-Selector" shown here will be sent postpaid to any applicant. Write to the Blueprint Department; write your name and address and "No. 68" legibly on a sheet of paper separate from letters to other departments. We regret to inform our correspondents, especially abroad, that U. S. postal regulations do not permit sending blueprints with magazines; nor can we undertake to accept blanket requests for "all blueprints."

added to the tuned oscillator circuit to cause the two tuning-condenser dials to read alike. When it has been adjusted so that the two tuning controls read alike for a given wavelength, their readings will remain alike throughout almost the entire

waveband. This a decided convenience, particularly when tuning for weak, distant stations.

**CONSTRUCTION AND WIRING**

The diagrams and photographic reproductions provide practically all the data required for the construction of the Pre-Selector; the only point that needs be touched upon is the mounting of the coils. Both L1 and L2 are mounted directly on the frames of their respective tuning condensers. L2 should be mounted in a vertical position with the small pick-up coil at the top. A tapped hole will be found in the rear of the frame of condenser C2, and a 6/32 screw passed through the hole in the brass mounting bracket of the coil and screwed into that in the condenser provides a convenient and substantial means for mounting.

The curved brass bracket which comes with L1 should be mounted on the frame of the coil by means of the two small screws provided. Its position should be that, when the coil is mounted in the position shown in the top view (Fig. A), the slotted lug on the bracket should be toward the panel and pointing down. Next, mount this coupler on the rear of condenser C1 by means of the screw provided. When in proper position, the notch in the lug of the mounting bracket should be astride the rib on the back of the condenser frame.

**SUPPLY AND INSTALLATION**

If it is used with a battery-operated receiver the same set of batteries may be used for the Pre-Selector. Or, if the receiver uses a "B" socket-power unit, that may also be used to provide the plate current for the Pre-Selector. If the receiver employs A.C. tubes, it will then be necessary to provide a set of three standard dry cells to supply the Pre-Selector's filament: one set of batteries will provide approximately 200 hours of actual service. The rheostat (R1) included in the filament circuit of the Pre-Selector is of resistance sufficiently high to permit these tubes to be operated safely from a six-volt source. With the supply voltage the rheostat should be turned on half-way to provide proper operating voltage for these tubes; if the supply source is 4 1/2 volts the rheostat should be turned on three-quarters. When dry cells are used the three-quarters position is correct while the cells are new; but the rheostat must be advanced as the cell voltage drops.

In some cases as, for instance, where the "B" socket-power unit is built permanently

(Continued on page 483)

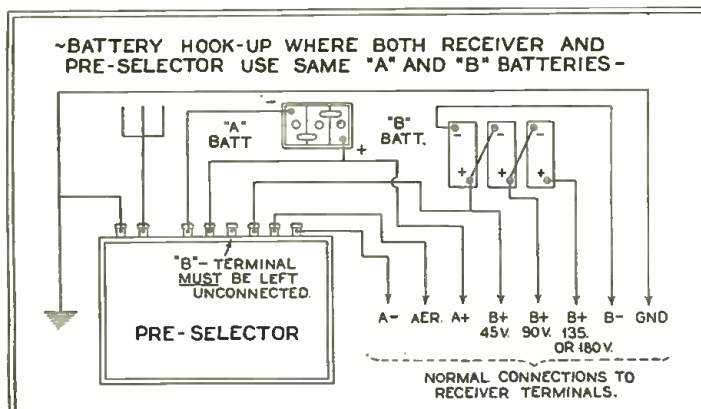

Fig. 2. Here the "B" connection is left unused, to avoid a short across the filaments of the 199-type tubes.

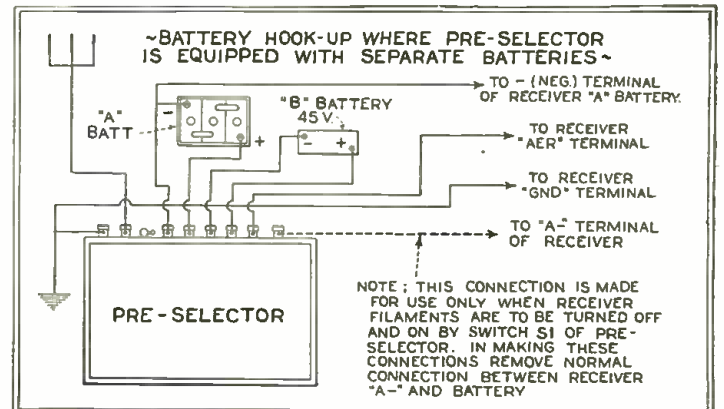

Fig. 3. Even though separate batteries are used, the connection shown makes remote control of the receiver easy.

# Magneto-Striction

An Interesting Field for the Radio Experimenter; How to Build a Magneto-Striction Oscillator

By M. J. Cuttler  
Radio News Laboratories

**F**ERROMAGNETIC substances (such as iron, cobalt, nickel and alloys into which those metals enter in considerable proportion) possess "magneto-strictive" properties; which means that they undergo slight mechanical alterations of shape, and some of their physical properties change when they are subjected to the influence of a magnetic field. This action of the magnetic field on such substances is manifested in a series of effects discovered at different epochs and known under various names.

The oldest among these is the "Joule effect," discovered by Joule about 1847; this is the variation of the length of a ferromagnetic rod exposed to a magnetic field. Let us consider an iron rod freely suspended inside of a long solenoid; an electric current of constant intensity flowing through a solenoid creates a magnetic field which is practically uniform within the solenoid over a great part of its length; provided that the ratio between the length and diameter is sufficiently high. This is illustrated in Fig. 1. The field strength within the coil is proportional to the intensity of the current, and the variation of the field may be governed through the regulation of the magnetizing current.

## AN ALTERNATING ACTION

Let us now examine what happens to the iron rod if the field inside the solenoid is varied from zero upwards. First, an elongation will take place. This will continue until the field's strength reaches a certain value, after which any further increase of the field will cause a contraction; the rod then becomes shorter, will again reach its

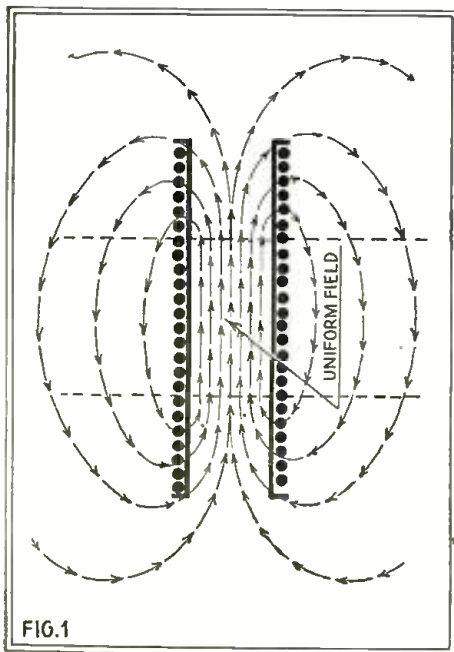

The magnetic field within a solenoid is practically uniform in distribution, as illustrated herewith.

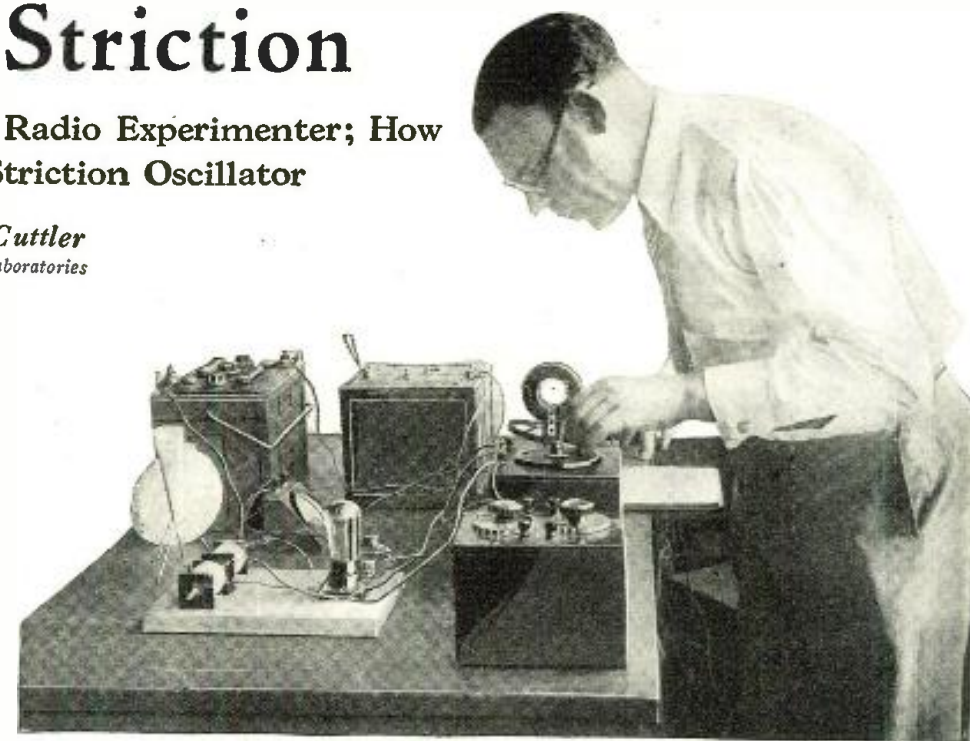

Mr. Cuttler is shown here testing the magneto-strictive oscillator described in the accompany article.

original value, and will then continue to contract until a saturation point is reached. Any further increase of the field strength will have no more effect on the length of the rod.

The behavior of other ferromagnetic substances under the same conditions will be different. Nickel, for instance, continuously *decreases* in its length; while cast cobalt, in contrast to iron, first contracts and then expands, reaches its original length and continues to elongate until saturation occurs. The relation between the strength of the magnetic field and the variation of the length is shown clearly in Fig. 2. (Both figures are taken from an article on magneto-striction by S. R. Williams, published in the *Bulletin of the National Research Council*, August, 1922.

Other ferromagnetic substances may respond differently, but one thing is common to them all; they vary in length (whether positively or negatively) with a rising field strength, and reach a point where saturation occurs, after which a further increase of the field has practically no effect on their length.

An important remark is to be made here; the Joule effect is dependent on the direction of the field. As the extent of the variations in the length of such rods is extremely minute, their measurement is a matter of great difficulty; the utmost care must be taken to avoid temperature variations and changes in other physical conditions, which may conceal the real values.

Various ingenious arrangements have been used for such measurements; Fig. 3 gives a schematic layout of the method used by Professor Williams. The method of operation is self-explanatory; the expansion or contraction of the rod under test is converted into angular rotation of the mirror by means of the lever.

## CORRESPONDING PHENOMENA

To the Joule effect corresponds another phenomenon which is its opposite; the "Villari effect." The forcible lengthening of a

ferromagnetic rod located in a magnetic field is accompanied by a variation in its magnetization or its permeability. As we have seen in the Joule effect, various substances behave differently under the same conditions; but there is a relation, for each metal, between its Villari effect and its Joule effect. An investigator (Nagaoka) who followed Joule, has confirmed his supposition that a magnetic field has an influence on the *volume* of a ferromagnetic substance.

Another very interesting phenomenon which belongs to the same group is the "Wiedemann effect" and its two inverse effects. The Wiedemann effect is the twisting of a rod under the influence of a combination of two fields, one longitudinal and one circular. Suppose a magnetic rod is clamped at one end inside of a long solenoid; then a current passing through the solenoid produces a uniform longitudinal field inside of it. If, at the same time, another current flows *through the rod*, a circular field will be created around it. If one of these currents is kept constant while the other is varied, or if both currents are varied, a rotation of the further end will be observed.

The two corresponding inverse effects are: first, a circular field is created when a rod which is located in a magnetic field is sut-

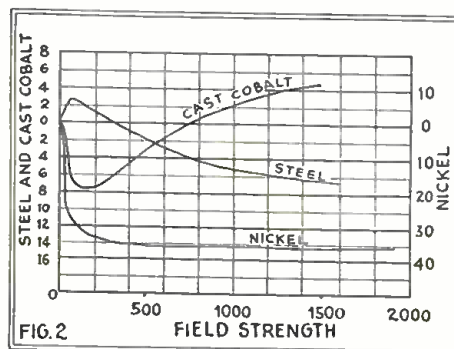

These curves show how various metals change in length under the influence of a magnetic field.

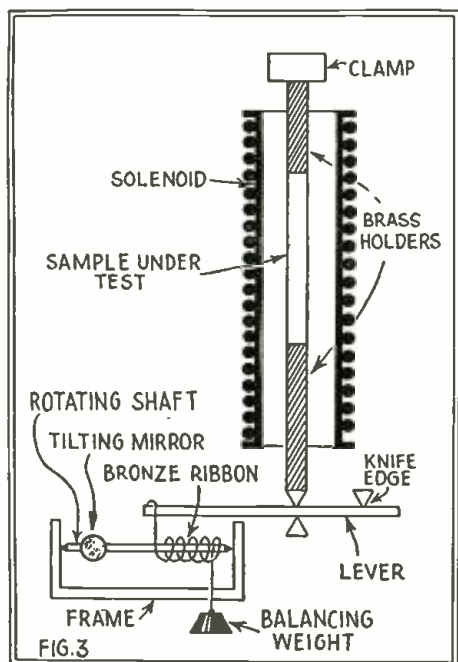

How the change in length of a rod is observed. As the rod varies, it unbalances the lever, which tightens or loosens the bronze ribbon. This causes the shaft to turn the mirror, the movement of which is readily observed.

denly twisted. A sensitive galvanometer connected across the rod will indicate a flow of current. Second, a longitudinal field is created along a rod to which a sudden twist is given, if an electric current is passing through it. A galvanometer connected to the terminals of the solenoid will show the existence of a current.

The schematic layout of the method used to measure the Wiedemann effect is shown in Fig. 4. Here, again, the rod is clamped at one end inside the solenoid. To the free end is attached a protruding brass extension which carries a small mirror. If the magnetizing current of the solenoid is constant, a rotation of the mirror will be observed when the electric current passing through the rod is varied.

There are many other phenomena belonging to the same group. Those of our readers who are more interested in this subject, we refer to the excellent and very clearly-written article on magnetostriction by Professor Williams, in the May, 1927, issue of the *Journal of the Optical Society of America*. Besides the general theoretical considerations and methods of measurement, the

reader will find there a most complete bibliographical notice on this subject.

DESIGN OF THE OSCILLATOR

The Joule effect has been very ingeniously applied by G. W. Pierce, director of the Croft Laboratory at Harvard University, in a series of electrical devices for which a British patent has been recently granted. Among them, the single-tube magnetostriction oscillator deserves the most attention. (By the way, Professor Pierce is the inventor of the single-tube piezo-electric oscillator, a device which is of almost universal use in broadcast stations, and of growing popularity among radio amateurs.)

The fundamental circuit of the nickel oscillator is shown in heavy lines in Fig. 5. The dotted part of the drawing represents an amplifying stage, which is not essential for the operation of the oscillator. As may be seen from the sketch, the essential element of the circuit is the ferromagnetic rod, which is clamped at its middle point. The two coils L1 and L2, of equal inductance value, are connected, respectively, to the grid and plate circuit, and surround the rod without touching it. The variable condenser C is connected to the grid and plate, and completes an oscillatory circuit. Disregarding the presence of the rod, the circuit is identical to the Hartley oscillator, with the exception that the coils are connected in the opposite direction.

When the oscillatory circuit is tuned by the variable condenser to a frequency which is close to the natural longitudinal frequency of the rod, a sudden rise in the plate current is observed in the milliammeter, and the rod begins to vibrate. If the frequency falls within the audible range, this vibration of the rod may be heard very distinctly. *The frequency of the current generated by the tube is now the same as the natural frequency of the rod.*

A CONSTANT-FREQUENCY CIRCUIT

If all elements are properly selected, the capacity of the tuning condenser may be considerably varied without having any disturbing effect on the frequency of the tube, which is now controlled exclusively by the vibrating rod. Similarly, it is not influenced by either a variation of the filament current or any reasonable change in the plate voltages. If the ferromagnetic substance used is of such a nature that the natural frequency of the rod is not affected by small

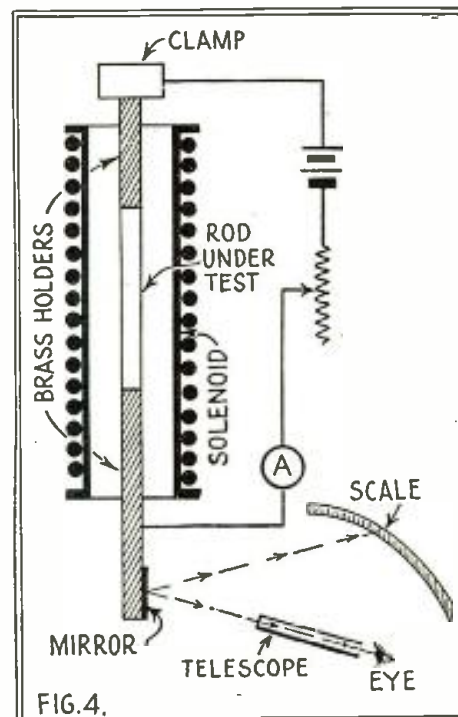

How the twisting of a rod under the influence of two magnetic fields is observed. One field is created by the solenoid; the other by the current passing through the rod and indicated by the ammeter A.

temperature fluctuations, the generated frequency is of remarkable constancy, and may be used as a standard for calibrating purposes.

This type of oscillator will cover a relatively wide range of frequencies, from a few hundred cycles up to 300,000 cycles per second and, as a standardizing device, fills in a gap between the range of the vacuum-tube-driven tuning fork and that of the piezo-electric oscillator. On the other hand, it may find a very wide field of application, in connection with synchronizing devices used in television and transmission of pictures over wires or radio.

THEORY OF OPERATION

We will now try to explain briefly the operation of a magnetostriction oscillator. Let us consider a ferromagnetic rod clamped at its middle point and surrounded by a coil through which an alternating current is passing (we assume that the coil does not touch the rod). During a complete cycle, the field strength inside of the coil varies from zero to maximum, from maximum to zero, again to maximum (in opposite direction) and comes back to zero again. As the Joule effect is independent of the direction of the field, the variation of the length of the rod during the same period will pass through zero to maximum, zero, maximum, and zero again. In other words, to each cycle of the magnetizing current will correspond two cycles of the variation of the length of the rod; that is to say, the rod will vibrate with a frequency which is twice that of the magnetizing current.

Suppose now that, simultaneously with the alternating current, a direct current flows through the coil. If the intensity of this direct current is higher than the amplitude of the alternating current, the resulting current will vary, but will never become zero. During one cycle, it will pass from minimum to maximum and come back to minimum once; and so will the magnetizing field. Accordingly, the length of the rod will vary in the same way and, to each cycle of the alternating current, will correspond one cycle

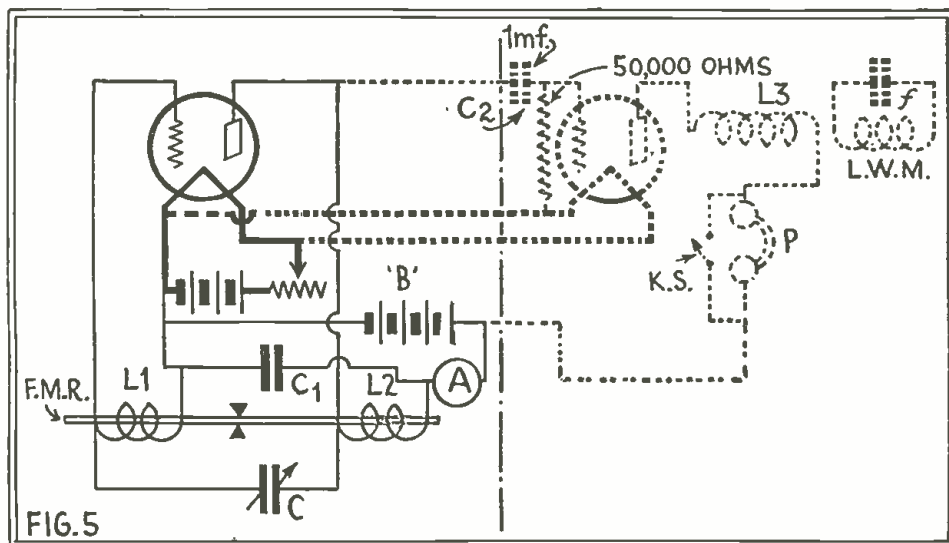

The circuit of the magnetostriction oscillator. The dotted portion indicates an additional amplifying stage. F.M.R., ferromagnetic rod; C1, 1-mf.; C, tuning condenser; L1, L2, inductors; A, plate milliammeter; P, telephone receivers; K.S., knife switch; L3, 800-turn honeycomb coil; L.W.M., long-wave wavemeter.

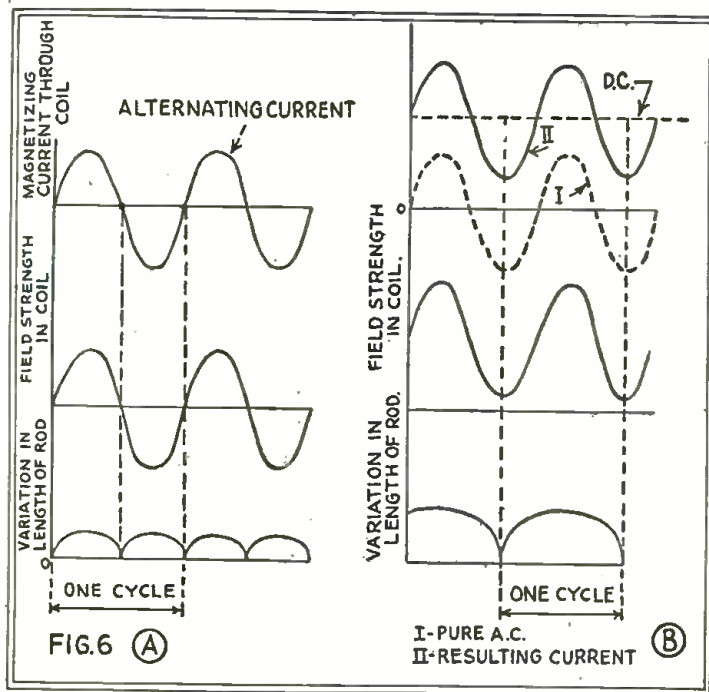

Fig. 6A illustrates the Joule effect. For each complete cycle of the magnetizing current, the rod within the magnetic field of that current vibrates twice; that is, the frequency of vibration of the rod is equal to twice the frequency of the alternating current. If, as in Fig. 6B, a direct current is added to the alternating one, the rod will vibrate at the frequency of the alternating current.

of the variation of the length of the rod. The rod will vibrate now with the same frequency as the alternating current. Those two cases are illustrated in Figs. 6A and 6B.

We will now return to the oscillator. To simplify the case, we will assume that there is no tuning condenser across the coils. (Such an oscillator may operate provided the amplifying power of the tube is high enough. A single tube may be replaced by an amplifier having several resistance-coupled stages.) One coil is then inserted into the grid circuit of the first stage, while the other is connected to the plate of the last stage. (One form of Professor Pierce's patent application.)

Suppose, now, that the rod is at rest and that the plate current has a constant intensity, which is determined by the characteristics of the tube and the applied voltages. The rod becomes magnetized under the influence of the field created by the second coil. This magnetization is not uniform, as the field strength along the rod is not uniform.

Should there happen a sudden variation of the plate current (due, for instance, to an exterior cause) a tendency in the rod to expand or contract, due to the Joule effect, will be caused instantly. The situation is somewhat similar to the case in which a shock is given to the rod in the line of its length. The particles of the metal are thrown out of balance, and longitudinal oscillation will take place in the rod under the action of the two forces of *elasticity* and *inertia*.

#### FREQUENCY OF THE ROD

The fundamental frequency of the rod may be found by dividing the *velocity of sound in the substance* of which the rod is composed, by twice its length. During the longitudinal oscillation of the rod, variation in its magnetization will occur (Villard effect). An oscillatory electromotive force will be created in each of the two coils; those electromotive forces will have the same fundamental frequency although, as a general rule, they will differ in their other elements.

A variation of the plate circuit then will cause the appearance of two electromotive forces in the grid coil; one due to the mutual

inductance between the two coils, and the other as a result of the Joule effect and its opposite. The resulting *emf.* will cause the plate current to fluctuate with the natural frequency of the rod. Ordinarily, the vibrations of the rod produced by a shock, or any other momentary disturbance in the internal balancing forces, would not continue indefinitely; as they are damped by the losses of energy and would die out very quickly. But here the conditions are different; if the elements are properly selected and the circuit is connected in the right way, the decrease in the amplitude after each oscillation may be compensated by the current in the tube, and a sustained longitudinal oscillation will take place in the rod. *The rod will be driven by the tube.* (Something similar we find in the oscillation of a pendulum maintained by

the driving force of a weight or a spring, as in a clock; the energy of the pendulum after each complete cycle is restored to its original value by a release of corresponding amount from the driving mechanism.) Simultaneously with the vibration of the rod, an oscillatory current, the frequency of which is controlled by the rod, will flow through the plate coil.

Tuning one of the coils with a condenser or both together (Hartley circuit) does not alter the fundamental principle of operation in this type of oscillator.

#### SELECTION OF APPARATUS

The above simplified theory gives us some ideas about the elements to be used and their constants and characteristics.

(1) The tube should be of the "high- $\mu$ " type, although satisfactory results may be obtained with other types.

(2) The substance of the rod is of the highest importance. It must have sharply-pronounced magneto-strictive properties and, preferably, should not reverse the direction of the change in its length during a single half-cycle of the magnetizing force. Comparing with Fig. 2, the characteristics of iron, cast cobalt and nickel, we find that the latter is the most suitable material of the three.

Some of the nickel alloys, such as invar (30% nickel, 63.8% iron and 0.2% carbon), nichrome (60% nickel, 12% chromium, 26% iron), or monel metal (66% nickel, 33.5% copper and 0.5% iron), have been found to require excessively long rods. For the purpose of obtaining low frequencies, the ends of a shorter rod may be loaded with weights. Also, we may use a tube made of a magneto-strictive substance which is filled out with a metal having a low sound-velocity; for instance, lead (4,025 feet per second, as compared to 16,315 for nickel).

(3) As to the shape and the inductance values of the coils, more complicated and, to a certain extent, contradictory, considerations enter. The plate coil has to be designed in accordance with the direct-current component of the peak current and the mag-

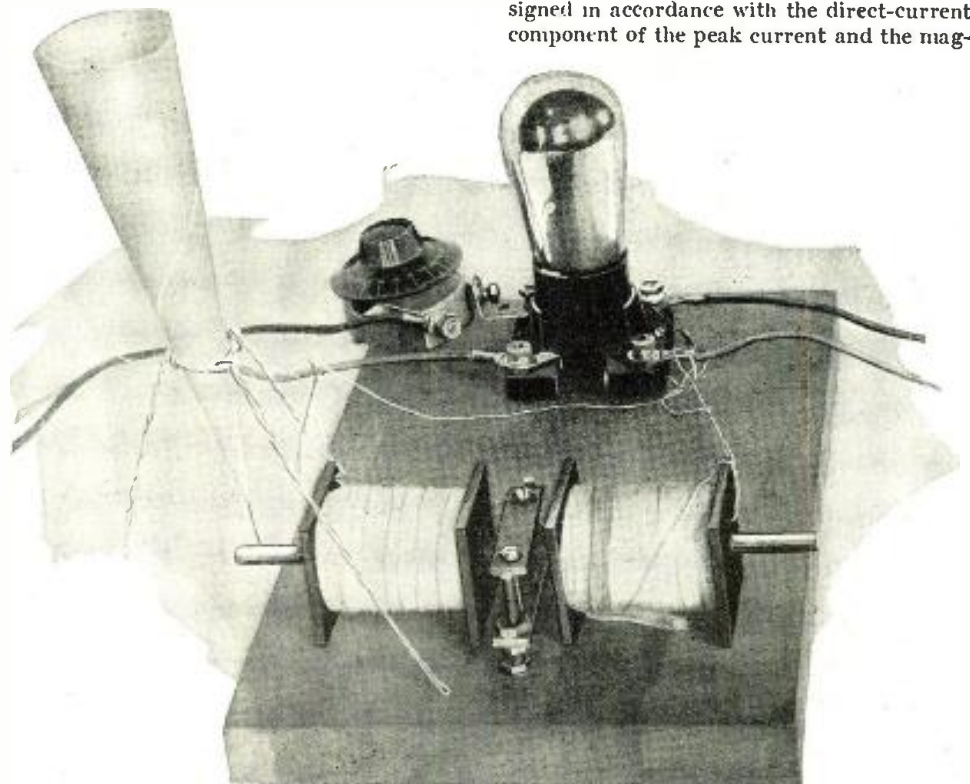

The complete magnetostriction oscillator as constructed in the RADIO NEWS Laboratory. The "loud speaker" resting on the vibrating rod is merely a rolled sheet of writing paper. Note the simplicity of the whole oscillator.

neto-strictive characteristics of the substance employed in the rod. A field so strong as to cause saturation (with regard to the Joule effect) must be avoided. On the other hand, an equal variation of the plate current will cause a larger Joule effect in the rod when a coil of larger inductance value is used. A similar consideration may be applied to the grid coil.

The dimensions of those coils lie within relatively large limits and the most desirable values may be obtained only through a complicated mathematical analysis, connected with a considerable amount of experimental work.

CONSTANTS OF A SET-UP

The photographs reproduced here show a magneto-strictive oscillator built in the RADIO NEWS Laboratories. The designers had no particular frequency in mind and no

special parts were constructed; they used parts under hand, from which it was expected to obtain some results.

The monel-metal rod is 1/4-inch in diameter and 7-13/64 inches long. The tube is of the standard 201A type, and has 90 volts on the plate. The method of clamping the rod between two knife-edges is clearly shown in Fig. 7. Three sets of different coils were used, with no very appreciable difference in the results. The coils shown in the pictures are wound on hard-rubber tubing, 1/2-inch in diameter and 2-3/16 inches long. There are 26 layers of approximately 60 turns each of No. 30 S.C.C. copper wire. Each coil has an inductance of approximately 25 millihenries. The secondaries of an intermediate-frequency iron-core transformer formed another set which was tried.

This oscillator is not powerful; neverthe-

less its operation could easily be detected, either by the milliammeter in the plate circuit, or by sound of a very high pitch. The acoustical effect can be amplified by the use of a small paper cone with a pin glued to its apex, as shown. Still better results were obtained with a paper drinking cup playing the role of a loud speaker.

A 13,000-CYCLE NOTE

The dotted part of Fig. 5 shows the method used to measure the frequency of current. A 1,000-turn honeycomb coil was inserted in the plate circuit of the amplifying stage, and the frequency was measured by a General Radio No. 224 wavemeter. This was in close accordance with the computed natural frequency of the rod. By Newton's formula, we calculate the velocity of sound in monel metal to be approximately 4,760 meters per second. Having divided this value by 0.366 (which is twice the length of the rod, expressed in meters), we found the same number, 13,000.

The phones in series with the honeycomb coil were short-circuited during the frequency measurements.

The tremendous penetrating power of such a high note is surprising. Although the intensity of the sound in the neighborhood of the rod was not very great, it could be heard distinctly in the adjoining rooms, separated by wood and glass partitions. Some of the members of the editorial staff, without suspecting the source, had complained of being annoyed by a hissing, "drilling" sound.

The construction of such an oscillator involves no great difficulties nor expense. The essential elements of success in experimenting are thoughtfulness, care and a knowledge of what is going on; and those of our readers who will build such an apparatus will certainly discover a large field for interesting experimental work, and perhaps valuable practical applications.

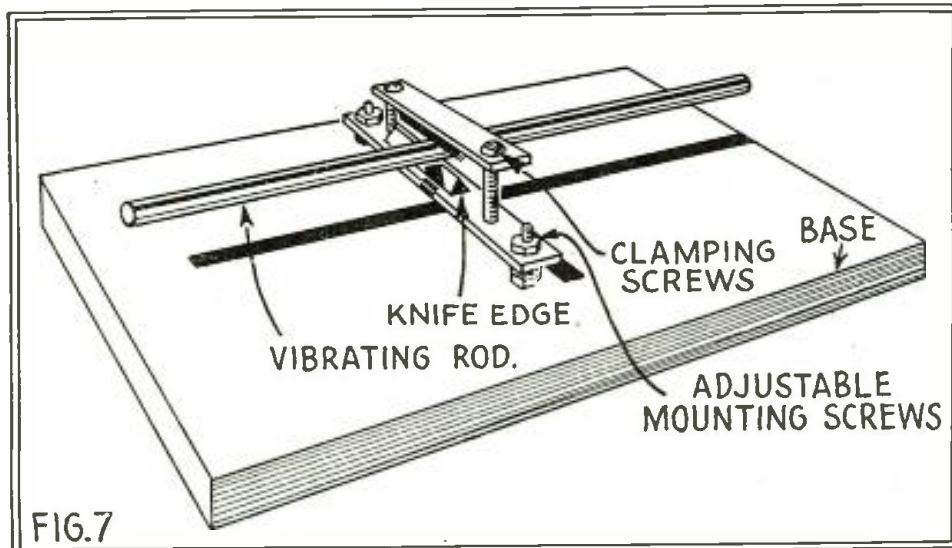

The illustration above shows just how the ferro-magnetic rod of monel or other suitable metal is clamped in place, without damping its vibrations. Any similar arrangement will be suitable; the base may be of wood half an inch thick, or more.

## Ways of Sensitizing the R. F. Amplifier with Stability

THE popular tuned-radio-frequency circuit of late has been improved by the widespread introduction of two methods of stabilization: namely, plate-voltage control and grid suppression. In fact, these methods have come to replace in large measure the previous potentiometer stabilizer which figured in early R.F. circuits, and, to a lesser extent, the neutralization method which played an important role a few years ago.

Few radio enthusiasts, even at this late date, seem to appreciate the significance of plate-voltage control. They take it for granted that 90 volts is approximately the correct voltage, and let it go at that. Of course, 90 volts will give results in R.F. amplification, but so will 67 1/2 and 135, if necessary. The radio-frequency tubes may be operated at maximum efficiency if provided with the proper plate voltage to meet existing conditions in the individual receiver. Thus the old-time potentiometer stabilizer, which serves to make the grid positive, may be dispensed with if the R.F. tubes have the precise plate voltage to keep them just a shade under oscillation. In the neutrodyne circuit the neutralizing condensers may be removed and the R.F. amplifier controlled by precise plate voltage, with a marked gain in sensitivity.

The potentiometer-stabilized set today is no longer efficient with the closely-packed wavelengths. It tunes too broadly, due to

making the grid positive. It draws too heavily on the plate supply. It even intro-  
(Continued on page 482)

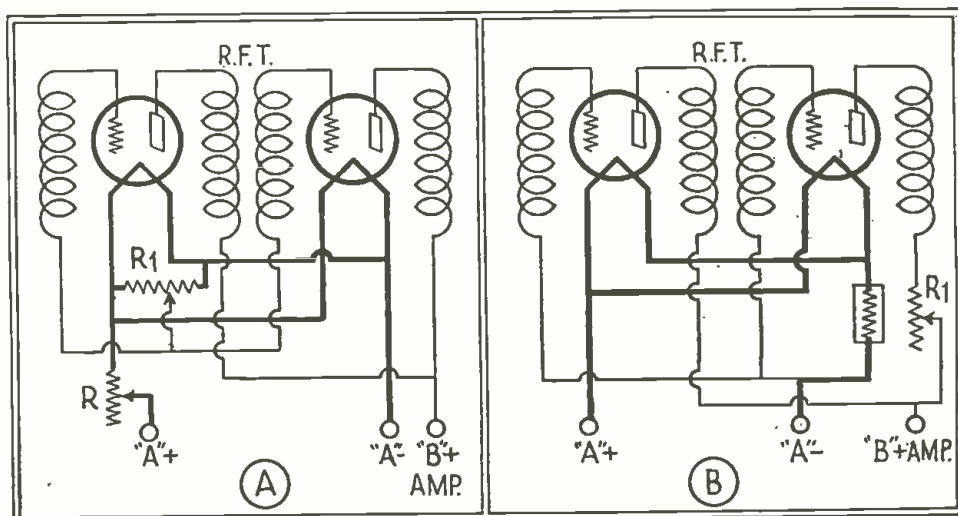

At A we have an "old-fashioned" 400-ohm-potentiometer arrangement, which regulates the action of the tube by varying its grid bias ("Eg" in the characteristic curve). The circuit shown at B is a modification which varies the plate voltage ("Ep") and thereby produces the desired regulation more satisfactorily. In this case the resistor R1 should have a range up to 500,000 ohms. Condensers and chokes are omitted for simplicity.

# Radio Wrinkles

## A Way to Mount a Home-Made Scanning Disc

FANS experimenting with television, who are making their equipment, find it quite difficult to mount the scanning disc on the shaft of the motor; particularly in view of the fact that the disc must run perfectly true in order to give good results. If the disc is home-made, the job is much harder than when a manufactured disc is used; but, in either case, the bushing must be quite large in order to prevent the disc from wobbling.

A satisfactory bushing for a television disc may be made from an old radio dial as illustrated in Fig. 1. First the hole in the center of the dial is drilled all the way through and, if necessary, it is enlarged to fit the shaft of the motor. Next, from two to four holes are drilled at equal distances around the rim of the dial. The dial is now placed in the exact center of the scanning disc, and used as a template for drilling holes in the scanning disc, which correspond with those drilled in the rim of the dial. After this has been accomplished it is necessary only to mount the dial on the scanning disc, with from two to four machine-

screws. When selecting a dial for this purpose, it is important to make sure that it is made of good bakelite. Many of the inexpensive dials are made of other compounds which do not have sufficient mechanical strength. —Contributed by Albert Baez, Jr., East Orange, N. J.

## Handy Current-Supply for The Experimenter

EXPERIMENTERS who desire to build and test all kinds of radio apparatus, yet at all times have one receiver which may be operated, are always faced with the question of power supply. Many have found it necessary to maintain two complete sets of batteries or power units, one for the household music maker and the other for experiments; while others have tried various

methods of using the same batteries for both purposes. However, in a large percentage of the cases where a single set of batteries is to be used for more than one purpose, the frequent reconnections are considered more of a nuisance than the saving is worth.

Many systems for rapid change-over of batteries from one set to another have been suggested and many of these are very satisfactory. In most cases, the instructions call for batteries to be mounted permanently under the work-table or in some other convenient location, and the binding posts of the batteries are connected to a terminal strip mounted on the work-table. With this system, any receiver may be connected easily with the binding posts on the terminal strip and there is very little danger of short-circuiting the cells. However, the task of fastening wires to the posts of the terminal strip requires considerable time, each time a set is connected.

A system which the writer has found very satisfactory for this purpose is illustrated in Fig. 2, below. It will be noticed that the

are prepared; each with a tip plug on one end and a connecting lug or spring clip on the other end.

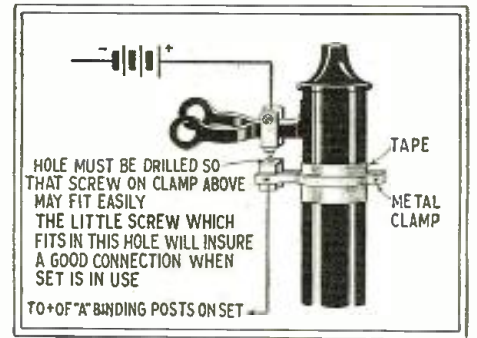

FIG. 3. The movement of the phone's automatic-switch hook can be used to cut off the loud speaker during conversation.

To facilitate connecting the receiver to the terminal strip, a strip of paper may be pasted in front of the tip jacks and the color of each wire of the battery cable may be marked in front of the particular jack with which it connects, as indicated. When connecting other apparatus to the batteries the separate connecting wires are used for the purpose. The connecting lug of each wire may be fastened to any binding post, and the tip plug may be inserted in the proper jack on the terminal strip.

Only seven tip jacks are shown on the terminal strip illustrated, but there is no reason why a greater number of plugs could not be used. For a complete work-table, the experimenter might include also jacks for the aerial, ground, loud speaker, and 110-volt A.C., as well as lower A.C. voltages for filament supply. —Contributed by E. L. Gibson, Atlanta, Ga.

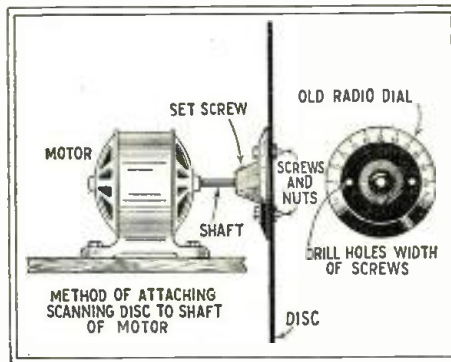

FIG. 1. Plain bakelite dials make strong bushings to attach a disc centrally to a motor shaft.

batteries are connected to a terminal strip in the usual manner, but the terminal strip is equipped with tip plugs instead of the usual binding posts. When this arrangement is followed, a tip plug is fastened to each wire of the battery cable leading from the set, and a number of connecting wires

## Telephone Automatically Cuts Off Radio Set

IN radio-equipped homes the loud speaker usually is considered a nuisance when trying to talk on the telephone. If loud signals are being received, it is necessary either to turn off the radio set or ask the person at the other end of the wire to repeat almost everything he says. Both of these things are annoying, but they may be eliminated easily with the simple device illustrated in Fig. 3. This device is a home-made switch which automatically disconnects the radio receiver when the telephone receiver is removed from the hook.

The construction of the switch is illustrated clearly in the drawing; it consists of two contacts, one of which is fastened to the receiver hook and the other to the vertical support of the telephone just below the hook. The contacts are placed so that they touch each other when the telephone receiver is on the hook; but so that the circuit is opened when the telephone re-

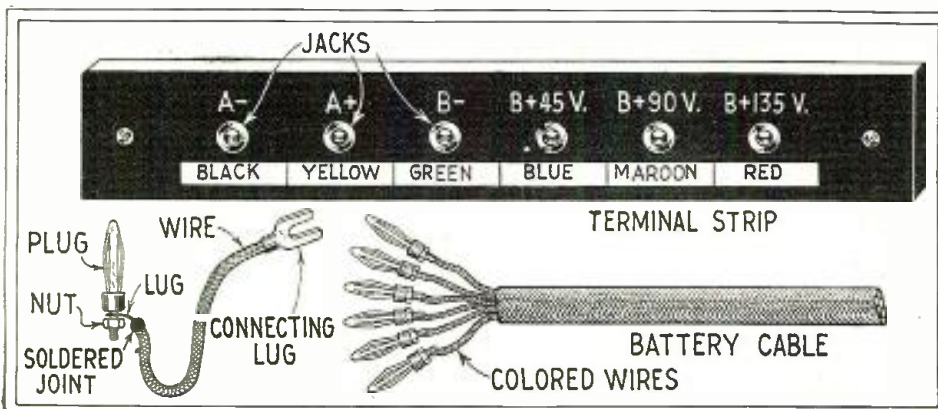

FIG. 2. This handy system makes it easy to plug in the battery cable of any one of several sets, or to connect an experimental hook-up to the proper voltages.



ceiver is removed. Both contacts should be carefully insulated from the telephone itself.

As suggested in the illustrations, the switch may be disconnected in the filament circuit of the set, thus turning off the tubes when the telephone receiver is picked up. However, this system is not very satisfactory unless the telephone is near the radio set; for long wires in the filament circuits tend to decrease the efficiency of the set. But the switch will give equally good results when connected in series with a loud-speaker wire.—Contributed by Francis Piscitelli, New York City.

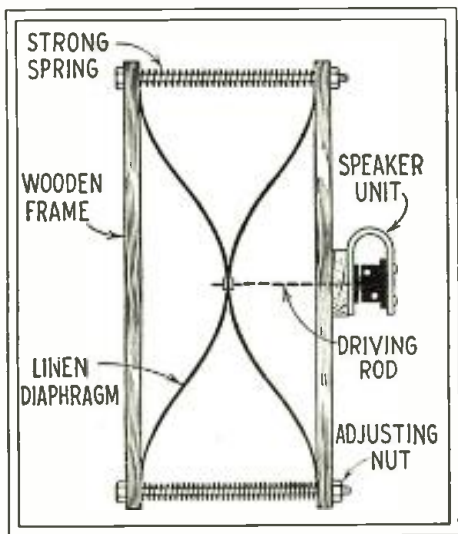

FIG. 4. By taking up the springs, it is made easier to join the two diaphragms; and they are easily balanced with the aid of the nuts at the corners.

### Spring Mounting Adjusts a Linen Speaker Easily

DURING the past year the linen-diaphragm speaker has become one of the most popular types in use. This speaker is rather bulky, in comparison with other types, but it provides very uniform reproduction over the entire frequency-range when properly adjusted, and is particularly satisfactory for low notes. There is another advantage which also must be considered in connection with these speakers; and that is, their design is such that they may be constructed at home.

Fans who have built linen-diaphragm speakers have found that satisfactory reproduction is obtained only when the proper tension is applied to the diaphragms. Also, for best results this tension must be very great; thus, as the quality is improved, the construction becomes increasingly difficult. This is because of the fact that in building the speaker the diaphragms must first be separated to the proper distance, and then the centers of the diaphragms must be brought together.

In a linen-diaphragm speaker of the type illustrated in Fig. 4, many of the difficulties experienced with the usual device of this type have been eliminated. In this speaker the usual wooden frames for the diaphragms are used, but the two frames are separated by springs instead of wooden spacers. The springs, which must be unusually strong, may be purchased at large hardware stores. They are placed over bolts which join the two frames.

In building the speaker, when the diaphragms are to be drawn together, the nuts on the bolts may be tightened in order to

compress the springs and reduce the distance between the two diaphragms. This makes it very much easier to join the diaphragms, and after this has been done the nuts may be loosened as much as needed. It will be seen that, as the nuts are loosened, the springs will expand and the tension on the diaphragm will increase. The use of the springs also greatly facilitates the adjustment of the receiver after it has been placed in operation.—Contributed by J. A. Johnson, Knapp, Wisconsin.

### Plug-in Tips Facilitate Condenser Trials

DURING experiments with new circuits, it is often necessary to change a fixed condenser frequently until the proper value is found. In most cases, changing a fixed condenser means disconnecting two soldered joints and making two new soldered connections. This operation requires a considerable amount of time, thus making it difficult to compare the results obtained with the two condensers. However, the problem would be simplified greatly if plug-in fixed condensers were used; as with this system it would be possible to make a change almost instantly.

Fig. 5 shows how a standard, molded fixed condenser may be converted easily into a plug-in condenser. The two terminal screws of the condenser should be removed and two standard tip plugs may be screwed into the threaded holes of the condenser. The plugs which are on the market have mounting screws which will fit into the threaded terminal holes of most of the

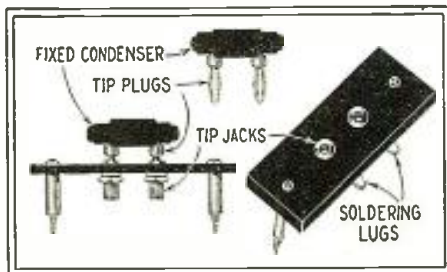

FIG. 5. Condensers of different values are readily tested at any place in a circuit with this arrangement.

molded condensers but, if the thread of the condenser is too large, the plug may be soldered in place.

After the condenser has been prepared as described above, it is necessary to make

RADIO NEWS has received from readers so many letters and ballots requesting more "Wrinkles" that it has been decided to re-establish the department. A year's subscription to RADIO NEWS will be given in compensation for each accepted item. If the author of the wrinkle is already a subscriber, his subscription will be extended one year or he may accept a one year's subscription to Science and Invention or Amazing Stories, both published by the Experimenter Publishing Co.

a receptacle. For this purpose a small bakelite panel 1x2x3/16 inches is used and two tip jacks are mounted on it, at the proper distance apart. Also, two extra holes are drilled at the ends for mounting screws. For experiments, the receptacle is connected in the circuit and various sizes of plug-in condensers are inserted until the proper value is found.—Contributed by Morris Dorsey, Atlanta, Ga.

### Home-Made Gauge Saves Time in Construction

WHEN you are drilling the front panel of a radio receiver, it is important to know the exact size of each hole required before starting to drill. If the set builder guesses at the size of the drill needed, the hole is apt to be too large or too small. If the hole is too large the mounting screws are apt to loosen up after the set has been in use for a short time; and, so far as small holes are concerned, it is always more trouble to enlarge them than it is to drill them to the correct size in the first place.

The amateur who has only a few drills available will find the device shown in Fig. 6 a great aid when drilling a front panel. A small piece of bakelite or hard wood, about 3x7x3/16 inches, is selected and in this one hole is drilled with each drill in the tool box. The various holes in the order of their size should be drilled in straight lines, about 1 inch apart. Next, the number on the shank of the drill should be marked in front of the corresponding hole for identification.

When making a set, it will be convenient to use the device described above to select (Continued on page 489)

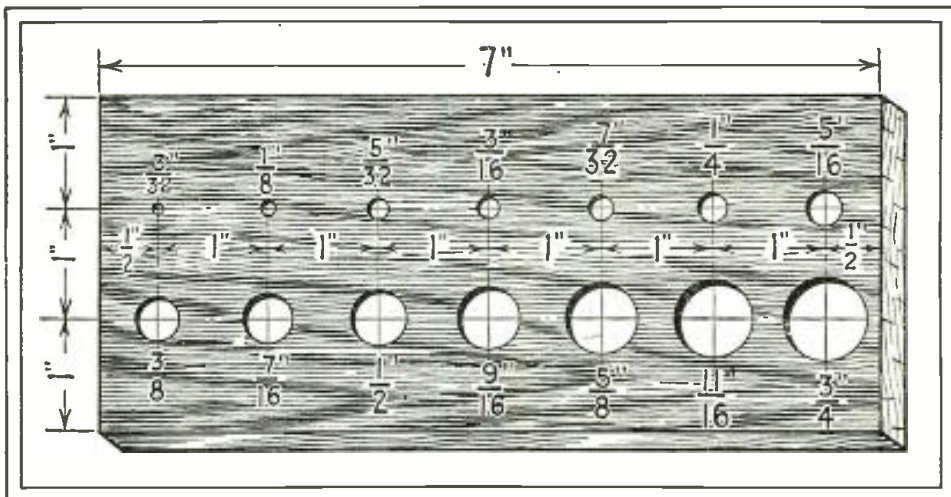

FIG. 6. A gauge prepared in this way will prevent many mistakes in drilling.



# On the Short Waves



**R**ADIO NEWS will welcome any definite information from our readers about unlisted stations which you may hear putting on programs, only if you hear the call or the announcement of location. Please give the wavelength as closely as you can estimate it. Because of the number of experimental transmissions by amateurs and others, we cannot undertake to list such stations in the short-wave broadcast list on another page, unless confirmation is received of their having a regular schedule; but all definite information received will be published here. Please consult data we have published before writing for information; we have no way to identify a station by its program or language, since many foreign stations transmit in several languages; nor even by its approximate wavelength, unless it is one of the larger and best-known transmitters.

## WHO IS THIS ARGENTINO?

Editor, RADIO NEWS:

On April 20th I heard a station on about 30 or 32 meters, from 6.25 to 9:15 p. m., E. S. T. There were selections in German, Spanish and English. At 8:25 the announcer said (in Spanish) it was Buenos Aires, Argentina. I held on until 11:20, but they had probably signed off. I will appreciate any information your readers can give me.

JOHN J. HANNIGAN, JR.,  
35 Maple St., Norwood, Mass.

## NEW WINNIPEG STATION

Editor, RADIO NEWS:

The Winnipeg station, operating on 27 meters and heard by your correspondent, Norman Wiswell, was not CKY, but HC, owned by James Richardson and Sons, Limited. Tests were broadcast for several days by the Marconi engineer who installed the equipment. The regular wavelength will be 25.6 meters and the call letters CJRX have been applied for, to take effect at the end of the present year.

The tests were very successful. Reports of loud-speaker reception have been received from the Yukon, from all corners of the North American

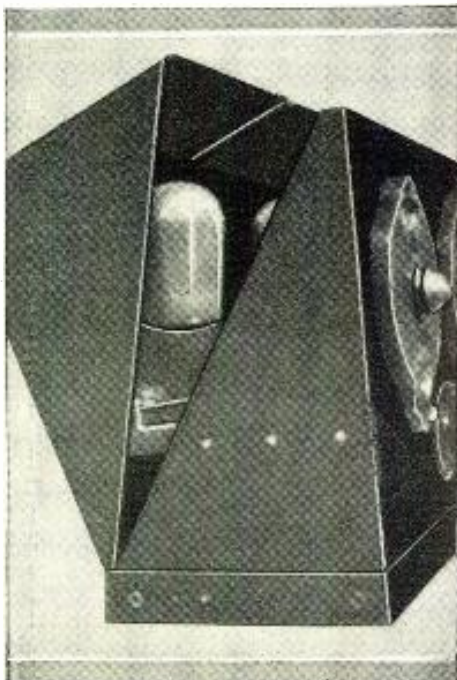

Mr. Tompkins' short-wave set in its old-style, but attractive, cabinet.

continent and from Australia, New Zealand and British New Guinea.

If this should catch the eye of your contributor, Mr. E. Blake, whom I had the pleasure of meeting in London some years ago, I hope he will listen in and try to hear us. We shall tie CJRX in with our regular broadcast station CJRM at Fleming, Sask., each afternoon, from 4:30 p. m. to 7:00 p. m., Central Standard Time. This schedule will be extended in the near future.

D. R. P. COATS,  
Radio Station CJRM, 1018 Grain  
Exchange Building, Winnipeg, Can.

## COSTA RICA STEPS OUT

Editor, RADIO NEWS:

I have been getting a strange station in Costa Rica (Central America). He is generally on Saturdays, Sundays and Wednesdays, sometimes other nights, from 10 to 11 p. m. Central Standard Time. He was first on about 38 meters, but of late is using 30. He announces in English and Spanish; just what city and who owns the station, I do not know, but would like to find out. I would like to thank RADIO NEWS for introducing me to short waves; it is a great pleasure to listen in at the bottom of radio.

CHARLES J. SCHROEDER,  
3125 No. Spangler St., Philadelphia, Pa.  
(Mr. Schroeder writes later: "I know for a fact it is not the Costa Rican government at San Jose, because the announcer says that he is an amateur station. I received him again Sunday night at 10:15 E. S. T. At 11 he said, I believe, '9:00 C. S. T., at Heredia, Costa Rica.' The next night he mentioned that his wavelength is 30.5 meters. I can't seem to get his call or name. I would like to get his address, as I get him at times R5 to R6 with two tubes.")

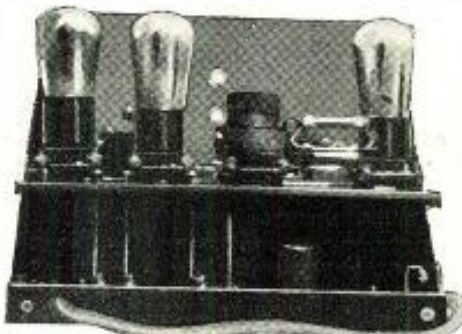

Mr. Tompkins' short-wave receiver, described below, compactly built and including two extra stages of transformer-coupled audio.

## A NEAT RECEIVER

Editor, RADIO NEWS:

The photographs show a short-wave set that I have been using for about three months. It is of the same style as the "Junk-Box," but I have put in an aerial coil and find that it cuts out dead spots. The housing is an R.C.A. No. 5 cabinet, made of solid brass, into which I have built a sub-panel to mount my four sockets; under them are my two audio transformers and the choke coil. You can see that this little outfit is very compact. It works wonderfully well on a "B" power unit, with 200 volts on a 171. I can get enough volume to hear a block away on KDKA, WABC, etc.

CHARLES B. TOMPKINS,  
220 Broad St., Waverley, N. Y.

## JAVA FOR BREAKFAST

Editor, RADIO NEWS:

I have heard Bandoeng, Java, on my RADIO NEWS Short-Wave receiver, from my previous location at St. Johns, Michigan, and have just received a confirmation. (The letter says, "You heard us testing on duplex telephony with Kootwijk—PCLL—on 18 meters. We are broadcasting Wednesdays from 1240 to 1440 G. M. T. Would you report us?—Studio Radiodienst, Bandoeng.")

FERRIS W. FITZPATRICK,  
Hq. Sect., Chanute Field, Rantoul, Illinois.

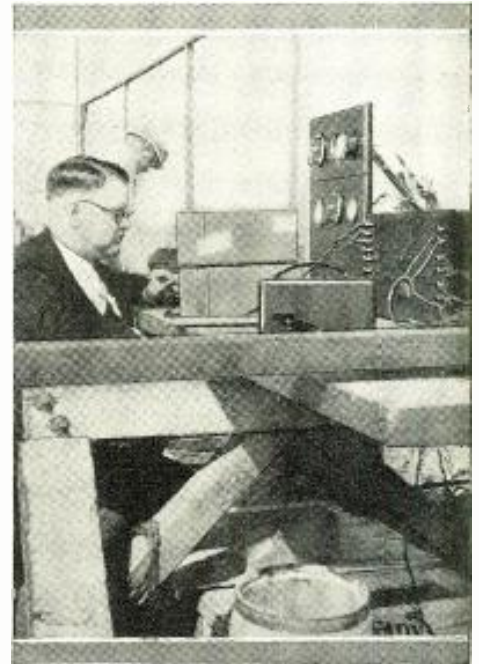

Mr. Dobyns at the microphone (shielded from the wind by boxes) of his short-wave station 6XBV, announcing the progress of the regatta from the official barge.

## SHORT-WAVE SPORTING ANNOUNCEMENTS

Station KGER, owned by C. Merwin Dobyns, of Long Beach, Calif., has also a short-wave phone transmitter 6XBV. During the recent Pacific Southwest Exposition regatta held in Long Beach harbor, this was used to transmit a description of the races to the main transmitter working on 215.7 meters. Owing to the carrying power of the short waves on 48.86 meters, it is quite possible they were heard much further than the higher-power transmissions of the broadcast station.

## RIGHT IN THE MADDING CROWD

Editor, RADIO NEWS:

I have received a letter from PCJJ dated July 25th, stating they are now on the air from 1600 to 2000 and 2300 to 0200 G. M. T., Tuesdays (11 to 3 and 6 to 9 E. S. T.); 1600 to 2000 Thursdays; and 0400 to 0700 and 1400 to 1700 Saturdays (from 11 p. m. Fridays to 2 a. m. and from 9 a. m. to noon E. S. T.) on 31.40 meters. I am situated at Third Avenue and 52nd Street, New York City; there is a power house around the corner which always causes noise on the short waves, and the "L" causes interference. I am using a 50-foot aerial of No. 12, and when reception is bad, I use an R.C.A. AG814 loop. I can receive PCJJ on Tuesdays and Saturdays. I would like to hear from other fans located in the middle of large cities how they get distance.

WILLIAM MORITZ,  
843 Third Ave., New York, N. Y.

## SHORT-WAVE ON SUPERHETS

Editor, RADIO NEWS:

In commenting on the communication from Baron von Hoenningen-Huene, you ask if other owners of standard superheterodynes have received short-wave signals.

When the L-2 Ultradyne was announced, I assembled the set with considerable success but did not receive any short-wave signals. However, that was before broadcasting on short waves was as commonplace as it is now.

Last winter I assembled the Magnaformer 9-8 to operate with A.C. tubes, at our winter home in south-eastern Florida. As an A.C. set it was a failure (as I anticipated it would be if built in accordance with the published instructions) so I rebuilt it to work on D.C. battery.

I tried it only one day working on A.C. and

the last program received was a musical number. I do not remember the call letters, but the announcer was very distinct in saying "located at Round Brook, New Jersey and broadcasting on a frequency of 5,000 kilocycles." This was the only time I ever had this experience but it shows that it is possible for some supers at least to pick up and reproduce short waves with good volume.

A. B. GARDNER,  
511 Green St., Dowagiac, Michigan.

Editor, RADIO NEWS:

Re Baron v. Hoyningen-Heune's letter, are either or both of his tuning coils reversed in the Ultradyne? Reversing the primary coil lessens the effectiveness of the set, of course, but makes it very interesting to handle.

HOWARD T. BEATON,  
Iroquois Falls, Ontario, Canada.

Editor, RADIO NEWS:

During the winter of 1926, I picked up one of KDKA's short-wave broadcasts, on an ordinary Pressley superhet. This was one of their Far North programs, broadcast for Alaska and Northern Canada, and came in on a dial setting that would correspond to a wavelength of about 260 meters. There was present the usual rapid fading, and the announcement stated that the broadcast was from KDKA's short-wave station, but I did not get any statement as to which wavelength was being used. I never did pick them up in this manner again, and I think possibly the reason they came in so strongly on this occasion was perhaps due to their using the limit of their power. There was nothing faint about their signals in this case; they came in on the speaker with plenty of volume.

At present I am using a super built up from the Silver-Marshall Lab. circuit, using their coils, but having Scott World's Record intermediates. Using the plug-in coils, I can get down to about 26 meters. I think I must have been one of the first to pick up RFM in this country. I got them sometime last December, and played them regularly for several weeks before I found out who they were.

I have been able to get KDKA on two wavelengths, WGY the same, but not a thing from WRNY or WLW, though I am always trying. Short waves may carry well with low power, but

there is no doubt that plenty of power helps a lot.

W. WALLACE CLENDENIN,  
Culver City, Calif.

Editor, RADIO NEWS:

I have built several Ultradyne circuits. I found, a few months ago, that by turning the condenser tuning the antenna coil completely out, I could tune in KDKA on their 62-meter wave during the afternoon with the oscillator condenser alone. The tuning was very sharp, and there was rapid fading, but it could be done day after day. Our reception of KDKA is very uncertain on their broadcast wavelength: I don't believe we average anything like good reception on two nights a week, in summer. But as long as I used an Ultradyne, I could get their short-wave broadcasts in the afternoon.

B. J. SANFORD, M.D.,  
Clare, Michigan.

FOR SCOUTMASTERS AND SCOUTS

Editor, RADIO NEWS:

Now that good radio weather is about to open up, maybe some scoutmaster might start a radio club that could work with the one I have started here, and also have the real "kick" of talking to some American Scout who is in a foreign country. Personally, I think it would be about as fine a training as any Scout could receive, and I would be very glad to send my ideas or rather suggestions to any scoutmaster who is willing to work. I have had some wonderful results from the different radio manufacturers, and they have all expressed a desire to help the good work along. Also, a lot of other letters have been received; but I have been too busy to take much time away from business to answer any but the ones from Scouts. Will you return the enclosed letter (printed below) to me, as I want to use it as an incentive for my boys to keep on trying.

GEORGE O. HOWARD,  
109 Tulsa Bldg., Tulsa, Oklahoma.

Dear Mr. Howard:

Having seen your letter in RADIO NEWS, I would like to write in commendation of your idea in teaching radio to the Scouts and getting them interested. I am a "ham" of three years experience

and certainly did not have the ease in starting that the fellows in the States enjoy. At present, after trying, and tedious, unsuccessful times with long-wave sets, I have reverted to short waves and can get plenty of good musical programs (barring the fading) as well as code.

I also am a Scout, 16 years of age, and would be glad if you could put me in touch with two or three Scouts also interested in radio. It has been pretty hard here to keep pounding the old brass when nobody else is interested in that line; but once in a while a brother "ham" has come along, and we have a pretty good time. Don't get the idea that I'm lonely, though; the fellows all have a respect for the work I've done, and I have plenty of pals. The only thing that I sure would like is to have someone in the old country to talk things over with—chew the rag, so to speak.

Well, GB till the next mag comes in. I would be glad to tell the fellows anything they want to know. 73 to you.

EARL A. HOOSE, JR., AC 2 AJ,  
American Bible Society, Peking, China.

USE OF SHORT-WAVE ADAPTER

Editor, RADIO NEWS:

On June 19 I received a Submariner and attached same to my Norden-Hauck Super 10, which has four audio stages, with a power tube in the last. The results were very gratifying. Each night I get the programs of 8NK wonderfully and on Sundays also, from 10:00 a. m. to 9:00 p. m., Central standard time. 2 NAF comes in one week daily and the next on Tuesday, Thursday and Saturday.

Your program from 2NAL on July 31, from 7:30 to 7:50 p. m., containing your talk about flying rockets and the orchestra numbers was heard but with severe fading.

PCJJ, Holland, broadcasts every Tuesday from 7:00 to 8:15 p. m. and on Fridays I enjoy the Spanish program from 7:45 to 9:00 p. m. It comes in exactly between 2NAL and 2NAF; the readings on the Submariner are 19, 19½ and 20.

ORESTES CENA,  
Tuxpam, Vera Cruz, Mexico.  
(Continued on page 493)

Station PCJJ, that of the Philips company at Eindhoven, Holland (transmitter at Hilversum), which so many of our readers have heard, is probably the most powerful transmitter in the world putting out short-wave broadcasts. Its total power is about 15 kilowatts in the aerial, and it works now on 31.40 meters. The illustrations which we reproduce show the compactness of this installation; at such high frequencies, care must be taken that leads do not introduce oscillatory circuits, as regeneration of 1/20,000th of the power would cause difficulty. This is minimized by changes of the fre-

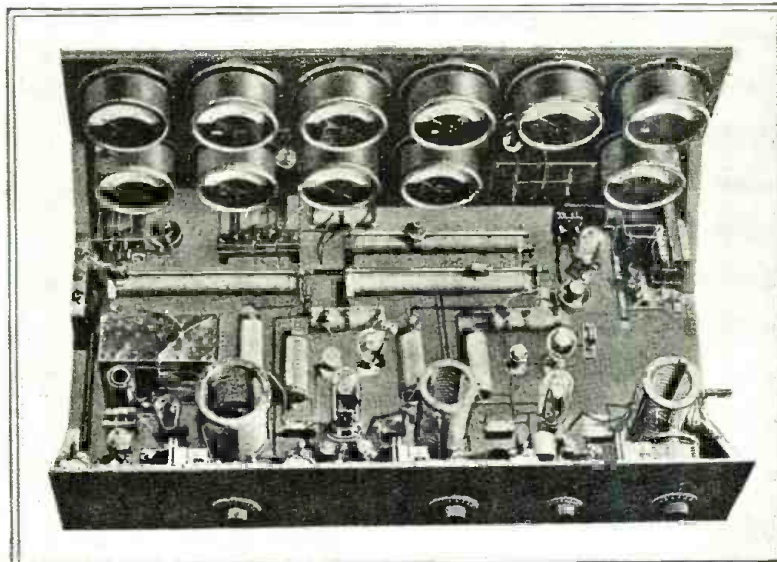

quency. The piezo-electric control crystal is contained in the box at the left in the center (uppermost) picture. It is ground to a frequency corresponding to a wavelength over 180 meters, and the unit puts out 50 watts on the second harmonic of this. In the middle section of the transmitter, shown at the lower left, the frequency is tripled and the output raised to 3 kilowatts. At the right of this picture, and the left of the third, is shown the 25-kv. tube which feeds the aerial—a single bronze wire. The remaining apparatus at the lower right comprises the modulators and their cooling system.

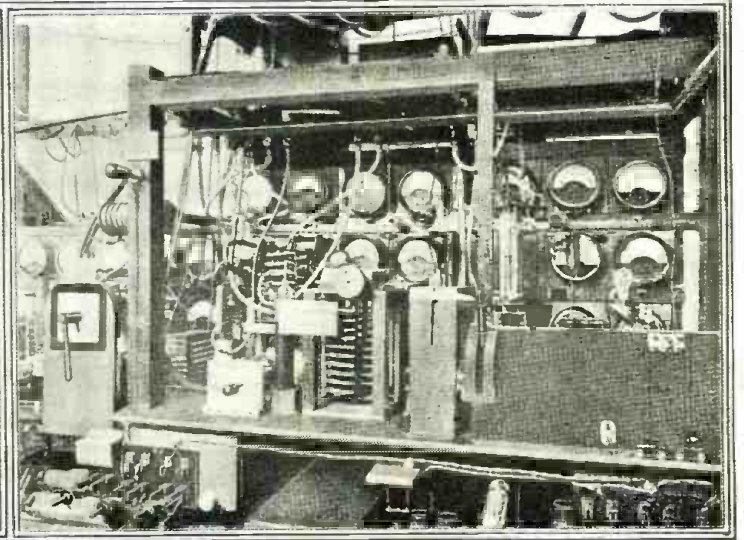
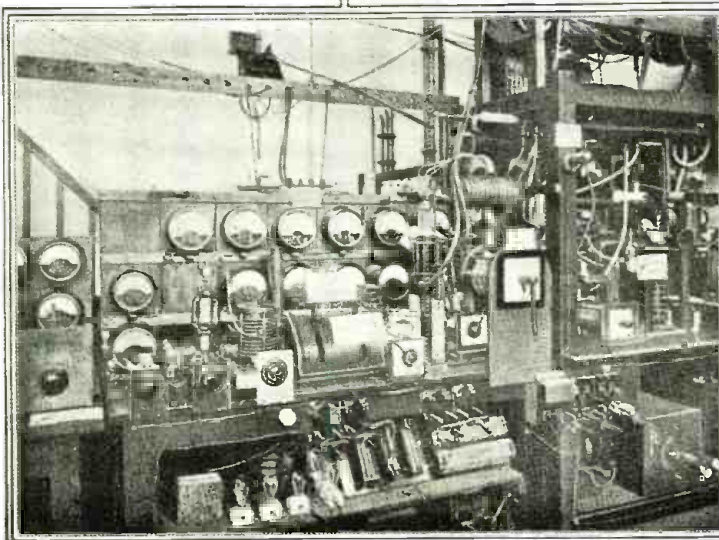

# The Radio Constructor's Own Pages



Wherein Custom and Home Set Builders and Experimenters  
All Over the World Swap Experiences and Suggestions About  
Hookups and Accessories



## REJUVENATING AN OLD-TIMER

Editor, RADIO NEWS:

A short time ago, I got hold of one of the old Westinghouse receivers consisting of a type RA tuner and a type DA detector-amplifier. This set, as you may know, uses three tubes of the WD-12 type, which I decided to replace with the present UX type. I replaced the three sockets with UX-type sockets and used a UX-200 in the detector socket and UX-201A tubes in the two audio stages. The second audio transformer was burned out, so I replaced it with a Thordarson with a turn ratio of 6:1. The grid leak and condenser I replaced with a .00025 Sangamo condenser and a 4-megohm grid leak. I used 45 volts on the detector plate and 90 volts on the plates of the audio tubes. For a loud speaker I used the Saal eccentric cone which, in my opinion, is about the best speaker I have yet heard for tone quality and its ability to handle great volume without blasting.

My aerial is about 150 feet long and 40 feet high and is of the single-strand type. My ground system is somewhat out of the ordinary, in that one connection is made to a water pipe while two other connections are made to two groups of three 1-inch pipes driven into the ground; the groups are spaced about 25 feet apart at right angles to each other. With this layout I have been able to get what I consider surprising results, considering the fact that we in the Hawaiian Islands are located over 2,000 miles from the mainland.

I have only been using this set for the last three days, but I am convinced that it outperforms a certain well-known 6-tube set which I happened to be using on trial; it outperforms it, not only in range, but in volume as well. The volume put out by this set is truly amazing; it not only fills my room but can be heard distinctly all over the house. In the short time I have been using it I have already logged the following stations: KGU, KGO, KFC, KPO, KHJ, KFSD, KOIN, KFI, KPLA, KOIL, KFVB, KNRC, KYA, KXX, KMTR, KOMO, 4QG, 2BL, besides some others which I could not make out because of fading. I am looking forward to enlarging this list considerably in the very near future, even though this is claimed to be the worst season of the year for radio reception.

Since this set employs the regenerative circuit, tuning must be carefully done to prevent marring the neighbors' reception; but my experience has been that it is very simple to tune if one keeps in mind the simple rudiments of tuning. I have noticed, however, that correct manipulation of the detector rheostat gives great flexibility. The amplifier rheostat, however, need not be touched in tuning; the best position is so that it is just turned on. In this position it gives maximum volume with a minimum consumption of current and a consequent lengthening of the life of the audio tubes.

It is very likely that there are others who have one of these sets and would like to remodel it. It is for these that I decided to write you and tell of my experiences, and for that reason I hope that you will find it possible to publish this letter.

O. F. STERNEMANN,  
Box 9, Hawi, Hawaii.

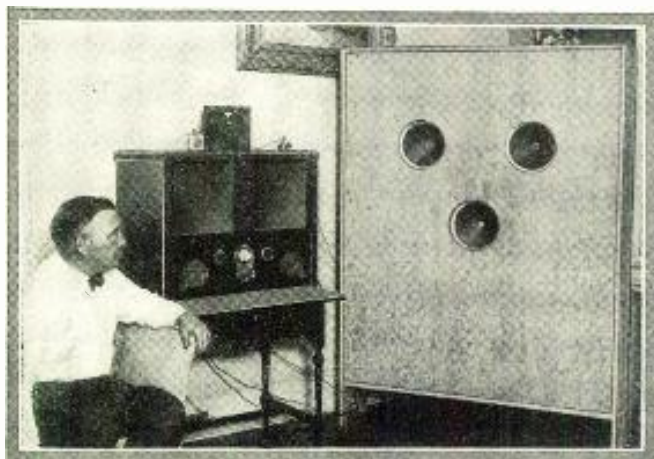

Mr. Mampe's triple speaker, viewed from the front of the baffle.

## FIRST X-RAY PHOTOGRAPHS OF RADIO SETS

Editor, RADIO NEWS:

Under the heading "X-Raying the Radio Set to Show Its Insides," on page 206 of RADIO NEWS for September, Baron Manfred von Ardenne is credited with the introduction of X-ray photography of wireless sets.

Unless he did this before 1919, I believe I was the first to employ X-rays for this purpose. I showed an X-ray photograph (which I took in 1919) of a wireless set to illustrate a lecture on wireless telephony to the Royal Society of Arts in London in 1920. (See *Wireless World*, for July 24, 1920). This radiograph, together with an ordinary photograph of the same set, is reproduced in my book, *History of Radio Telegraphy and Telephony*, published by Chapman & Hall, Ltd., London, 1926.

I shall be obliged if you will publish this letter in your excellent journal, to which I have been a regular subscriber for many years.

G. G. BLAKE,

8-10 Onslow Road, Richmond, Surrey, England.

## MULTIPLE GROUND MAKES A FRIEND

Editor, RADIO NEWS:

I always read your magazine with the deepest interest and get lots of good out of it. For example, "Encircling the World with a Two-Tube Set," in the March issue, made mention of using several grounds. This was tried by a friend of mine in Ottawa to whom I passed the magazine. The results were beyond expectation, and have made him a regular reader of your magazine. Others are to try the idea. With sincere thanks for the information contained in your recent letter.

J. PRUDHOMME,

139 Boteher Street, Ottawa, Canada.

## THANKING THE WRITER

Editor, RADIO NEWS:

In keeping with your policy of giving us the latest and best, you have again conferred a great treat on the Browning-Drake fans. In the August issue of RADIO NEWS, you published an article by Mr. C. A. Oldroyd, of Barrow-on-Furness (England), "A Booster Unit for the Browning-Drake."

I built one of the "Boosters" and it has done wonders for that selective and wonderful DX-getter. The results are almost beyond belief. During this excessive heat and fearful static condition of the atmosphere, I have been able to bring in the Gulf State stations and the Atlantic coast, with greater volume than is ordinarily obtained during the fall and winter months. Also, I have been able to get a great many of the low-powered stations (some at quite a distance) which, under the best of conditions, are hard to bring in, and all of these on the loud speaker.

It is true that we have one more tuning control, but the results more than compensate, and, as the dials "track" pretty closely, it is very little trouble.

J. N. BACON,  
Oshkosh, Wisconsin.

O. Mampe of Patience, N. J., opposite New York City, is a radio constructor who goes in for elaborate effects. He has built a speaker, with three electrodynamic-cone units, whose appearance is shown here; the baffle board is 4½ feet wide and 5½ feet high, and made of ¾-inch wood. The three speaker units are supported on shelves at the rear, as will be seen from the view in the third column; and other shelves are provided for the power supply and amplifier. The reproducer assembly is admirably adapted for high quality under control; though it is hardly suitable to be turned loose under full power indoors. Constructors who desire to build a speaker with even one dynamic unit of this type are referred to pages 438-441 of this issue for information.

## MR. PORTER WILL BILL YOU

Editor, RADIO NEWS:

I will send you and Mr. Porter my heartfelt thanks for the permanent hook-up of a phonograph pick-up to a receiver (page 53, July, 1928 RADIO NEWS). I have a very expensive phonograph, and by a little expenditure and some of my own time, I have a neat job at a saving of about \$500 compared with buying one of the new combinations. This is a feature which, I suppose, appeals to the majority of home constructors. I am using a SCIENCE AND INVENTION circuit of 1925, but it works fine.

A. CARL CUTSINGER,

960 East Orange Grove Ave., Pasadena, Calif.



A rear view of Mr. Mampe's speaker, showing the three electrodynamic cones.

## LUCKY YOU WERE NOT FLYING

Editor, RADIO NEWS:

Today I bought the June issue of RADIO NEWS and read "The Port of Missing Airplanes." The story is indeed a good one, and I believe it is quite possible for a person to be overcome with dizziness by listening to a shrill note sent through a pair of headphones, as in the story. While listening to my set, I decided to change the grid leak, still wearing the phones. The set started to oscillate and the whistling made me dizzy. I am not telling you of this as a scientific experiment, but an actual happening. In closing, I wish to say that I greatly enjoy the stories printed in your magazine.

NILS GJERDE,  
5612 Sixth Ave., Brooklyn, N. Y.

(Some of our readers are not in entire agreement as to the fiction which RADIO NEWS carries. However, the series of stories referred to is, in our opinion and that of many others, worth reading purely for the scientific considerations which it presents.)

## OUT IN THE WOODS

Editor, RADIO NEWS:

I feel a great deal of credit is due the World's Record Economy Eight, as I built one of these sets. I am spending the summer here and our camp is in the heart of a large forest, and located in such a way that I cannot put the aerial above the trees. I am using 125 feet of aerial, including lead-in, and have received forty DX stations in one week's time with no overlaps or interference by other stations. Two of them are real DX at this time of year, I feel; they are KJF and WKAQ. I would appreciate your publishing this.

CHESTER L. PRICE,  
Wanakena, New York.

**SET BUILDING IN FRANCE**

Editor, RADIO NEWS:

Just a few lines of appreciation to yourself and RADIO NEWS, the current copy of which was a boon companion to me during an exceedingly violent electrical storm up here (at Hohnneck, in the Vosges Mountains). I was far too deeply engrossed in your description of the Screen-Grid Stroboddyne to notice such trifles as storms. I have taken RADIO NEWS since its first edition but, because of traveling all over the world, I had to plan with my newsdealer in New York to hold over my copies until my return. Now that I have a permanent address in Paris, I have at last become a subscriber.

Here is something that would be of great assistance to me and undoubtedly to many other fans over here, and that is a table comparing the relative sizes of wires between the American B & S gauge and the French gauge which is given in mills. I desire to build a Stroboddyne a l' Americaine, but cannot do so until I know what size wire is equivalent to that given. (See below). I fell down on the construction of the RADIO NEWS Short-Wave set on this account and am anxious to complete it and fish for good old WRNY on the 30.91-meter wave.

We have not yet come to the screen-grid tube in France, but I have found that the "Metal Radio" factories are putting one on the market in the near future, and if it has similar characteristics to the 222, I shall build the Stroboddyne S. G. as described.

I am at present using a Stroboddyne built by M. Chrétien, the originator of the circuit, but the American hook-up is way ahead of it. My set has coils for both wavebands (180 to 500 and 500 to 3,000 meters) incorporated, and the change is made by a commutator on the panel.

By the way, the relay of the Tunney-Meeney fight over Daventry and 2LO was wonderful. I received it in Paris clear as a bell. Absolutely no fading right up to WGY's announcement of the time signal, when England acknowledged the defeat of her champion with silence immediate and profound. But that relay certainly spoke worlds of the future of radio from an international viewpoint; may good old RADIO NEWS stick and grow with it.

R. W. HUMPHREYS,  
57 Boulevard Suchet, Paris 16e, France

**Metric Measurements of Wire**

(Here are the measurements of copper wire—the metal conductor only—in the metric system: the diameter in millimeters and the area in square millimeters. This may be of benefit to some of our other friends abroad. The gauge is the familiar American Brown & Sharpe.—EDITOR.)

Gauge	Diam.	Area	Gauge	Diam.	Area
14	1.628	2.081	28	0.321	0.081
16	1.291	1.309	30	0.255	0.051
18	1.024	0.823	32	0.202	0.032
20	0.812	0.518	34	0.160	0.020
22	0.644	0.325	36	0.127	0.013
24	0.511	0.205	38	0.101	0.008
26	0.405	0.123	40	0.080	0.005

**NO PANCAKES FOR BREAKFAST**

Editor, RADIO NEWS:

I attach a snapshot of two speakers made of scrap paper, a cone and a horn built along the lines of the model described in Chester Schenck's article in the June issue of RADIO NEWS. The horn was built around a form made from an old orange crate and some stiff cardboard; the form



Mr. Stewart, above, flanked on either side by a low-cost loud speaker made as described. It will be hard to lower his record unless you steal a unit.

being well coated with talcum powder to insure its easy removal after the horn had thoroughly dried. For the material, I used all the old magazines, newspapers, wrapping paper and so forth that was available, and for paste a mixture of flour and water. The job was rather tedious; but, as I am not especially fond of work anyway, it came in handy to apply a layer or two a day and allow time for drying. The horn was finally built up to near ¼-inch in thickness, but is still too thin. Only one brace is used, that being made of four pieces of wood, ¾-inch square and about twelve inches long, nailed together in the form of a square and slipped down on the bell as far as it will go and pasted in position. The tone is as good as that of several manufactured horns I've heard, and better than some.

The cone consists of one layer of heavy brown wrapping paper with two layers of newspapers pasted on the outside, three layers in all. A circle 36 inches in diameter was laid off on this and a V-shaped slice cut out. That gave me a cone 34 inches in diameter and 7 inches deep. A loop of soft copper wire was pasted on the outer edge and the string used for mounting the cone in the square wooden framework was laced back and forth through the wire and to the frame. A 1 x 2 bolted to the frame, supports a cigar box, which, in turn, supports the driving unit, one taken from a Musicone. The main item of expense in this big cone was five cents for the two bolts in the 1 x 2; the flour for the paste was stolen from the family larder, so cost nothing.

The cone is by far the better of the two. Both reproduce well the bass and middle-register notes; but we have lots of static down in this hot country and it is not so objectionable on the cone as on the horn. The set driving these speakers is home-built, a Browning-Drake type, with a screen-grid R.F. stage, 200A detector, Thorndarson Autotformer audio amplifier with a UX-112 in the last socket. Volume and quality de luxe!

GUY STEWART,  
Utopia, Texas.

**A SENSITIVE FOUR-TUBER**

Editor, RADIO NEWS:

I am sending my four-tube circuit, which was very much like Mr. McCormick's till the screen-grid tube came out. I think that the only real difference was that I changed my antenna coil by doing away with the fixed condenser and tapping at the twelfth turn from the filament end. I have written Mr. McCormick, advising him to put a screen-grid tube in his R.F. stage; it requires only a little changing and it is well worth the trouble. With his DX record, using a 201A, he certainly should step out with the screen-grid hook-up for a few more miles.

This circuit is very sensitive and selective with a short antenna, and the west coast comes in with plenty of volume.

We have only from 7:30 p. m. until midnight to do any DXing, on account of the high-power naval station NSS here, which sends off a heavy mush or "back-wash"; so you can see we do not have a shot at the foreigners. My most distant stations are California, Mexico, Cuba and Canada; but remember we have to do this early.

This circuit was originally the "Reactodyne" published by RADIO NEWS in 1924. I hope you can interest a few others in this circuit.

FRANCIS E. ENGLE,  
14 Cathedral St., Annapolis, Md.

**A SINGLE-CONTROL SHORT-WAVER**

Editor, RADIO NEWS:

I am enclosing a diagram of a "one-hand" short-wave receiver I have been using for about four months. I use Aero short-wave coils; with this arrangement I am able to set the feed-back control condenser for a given coil and sweep the whole range without any other adjustment until the desired signal is found. Then a little adjustment of the detector filament and I am all set to listen. No more "holes," etc.

I am using special R.F. chokes. While an Aero No. 10 will work very well, a choke with very low inductance must be used on S. W. I use No. 36 S.C.C. on a piece of round or square ¼-inch bakelite, about 6 inches long; start winding one end about 40 turns, space ¼-inch, then 60 turns, space ¼-inch, 80 turns, and so on till the space is used up. I find the 112A tube the best detector for this receiver; the rest is standard.

W. E. SMITH,  
Oak Forest, Illinois.

**MR. LOVELESS IS NOT SOLELY TO BLAME**

Editor, RADIO NEWS:

I was interested in finding in the article on the Loveless aerial the description of a circuit embodying the principle of my patent No. 1,668,261, issued to me by the patent office May 1, 1928; application for the same having been filed Dec. 27, 1923. An examination of this patent will reveal the validity of my claim; for it will be there seen that specific claim is there made for aerial circuits together with a claim embodying the same principle in radio sets themselves. The discovery of the principle involved was made by me as far back as 1920, while engaged as professor of physics in the University of Santa Clara.

(Rev.) RICHARD H. BELL, S. J.,  
St. Ignatius College, 2130 Fulton St.,  
San Francisco, Calif.

(Continued on page 498)

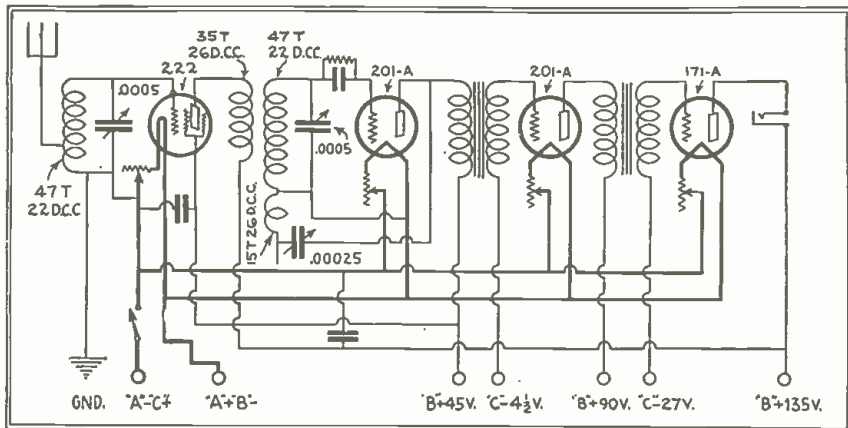

Mr. Engle's hook-up differs from the "Reactodyne" in its aerial circuit; the latter was very loosely coupled in the original. The primaries are wound jumble-fashion and placed inside the secondaries, which are on 3-inch tubing. Transformers are S.M. 220s. If e suggest a fixed ballast also in the 222's "A-."

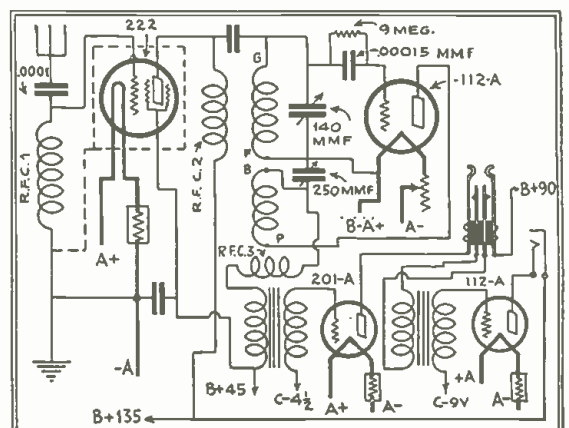

Mr. Smith's set is not a reflex, as first glance might suggest, but a short-waver with two A.F. amplification stages. Our readers may test it to see if ease of operation is accompanied by necessary sensitivity and control.



# Radio News Laboratories



**RADIO** manufacturers are invited to send to RADIO NEWS LABORATORIES samples of their products for test. It does not matter whether or not they advertise in RADIO NEWS, the RADIO NEWS LABORATORIES being an independent organization, with the improvement of radio apparatus as its aim. If, after being tested, the instruments submitted prove to be built according to modern radio engineering practice, they will each be awarded a certificate of merit; and that apparatus which embodies novel, as well as meritorious features in design and operation, will be described in this department, or in the "What's New in Radio" department, as its news value and general interest for our readers shall deserve. If the apparatus does not pass the Laboratory tests, it will be returned to the manufacturer with suggestions for improve-

ments. No "write-ups" sent by manufacturers are published in these pages, and only apparatus which has been tested in the Laboratories and found of good mechanical and electrical construction is given a certificate. As the service of the RADIO NEWS LABORATORIES is free to all manufacturers, whether they are advertisers or not, it is necessary that all goods to be tested be forwarded prepaid, otherwise they cannot be accepted. Apparatus ready for, or already on, the market will be tested for manufacturers free of charge. Apparatus in process of development will be tested at a charge of \$2.00 per hour required to do the work. Address all communications and all parcels to RADIO NEWS LABORATORIES, 230 Fifth Avenue, New York City. Readers will be informed on request if any article has been issued a Certificate of Merit.

## AUDIO-FREQUENCY TRANSFORMER

The "Type AX" audio-frequency transformer shown, submitted by the Sangamo Electric Company, Springfield, Ill., is of excellent mechanical and electrical design. The amplification of the transformer maintained a value almost constant from 32 to 5,000 cycles, when used with the 201A-type tube. The primary inductance, with a plate current of 3 milliamperes, was found to be approximately 80 henries. The transformer has a ratio of three to one; and excellent quality with great volume was obtained when it was used in the conventional audio amplifier employing the 201A and 171 tubes. The transformer is identified by a yellow spot. The core and winding are completely shielded by an iron housing of olive-green finish. The dimensions of the base are  $2\frac{1}{2}$  x  $2\frac{1}{2}$  inches, while the height is 3 inches.

AWARDED THE RADIO NEWS LABORATORIES CERTIFICATE OF MERIT NO. 2421.



## AUDIO-FREQUENCY CHOKE

The "Type E" audio-frequency choke or "impedance" submitted by the same manufacturer, is of the same size and shape as their "Type AX" A.F. transformer illustrated above. It is used as an output impedance for the 171-type power tube, in which case the entire inductance is employed. It may be used also as an output impedance for the 112- or 210-type power tubes by using the portion of the winding between "T" and "B+." It is designed to match the impedance of the modern power tubes and, for this reason, allows the lower frequencies to be better reproduced. When it is employed in the output circuit, a blocking condenser external to the choke must also be used; this should have from 2 to 4 mf. capacity, and be of voltage rating suitable to withstand safely the maximum voltage of the power stage. The inductance was found to be within 10% of the rated value of 30 henries, when measured at 60 cycles; the ohmic resistance is approximately 570. The metal case is finished in dark red

and the device is identified by a "mandarin red" spot.

AWARDED THE RADIO NEWS LABORATORIES CERTIFICATE OF MERIT NO. 2422.

## A.C.-OPERATED RECEIVER

The "Packard" 8-tube radio receiver shown, submitted by the Packard Radio Co., 2161 No. California Ave., Chicago, Ill., is of the all-electric type, using five 226 A.C. tubes, one 227 A.C. (heated-cathode) detector tube, and two 171 power tubes; it operates directly from the 110-volt, 60-cycle, house-lighting circuit. The low-voltage A.C. current for the filaments of the tubes is supplied by separate windings of the power transformer, and the "B" voltages are provided by a full-wave rectifier of the 280 type in connection with an efficient filter system, the chokes of which are contained in the same metal housing with the power transformer. Three stages of tuned radio frequency of modern design, using 226-type tubes, give ample selectivity and sensitivity. The tuning inductors are of the compact, small-field type, enclosed in individual shield cans. The radio-frequency stages are followed by a conventional 227-type detector, which feeds into two stages of transformer-coupled (1:1 ratio) audio frequency, followed by a stage of push-pull power amplification of the 171 type. The speaker windings are protected by a balanced output choke. The tuning of the R.F. and detector circuits is accomplished by one control, which is geared to the common shaft of the condenser rotors; the scale is of the drum type. A fine adjustment of tuning for DX work is accomplished by means of the levers protruding through the panel on each side of the tuning control. A power rheostat with a panel voltmeter is provided, to maintain the filaments



of the tubes at the proper temperature. The control at the right of the set is provided for controlling oscillations and volume, and there is a sub-panel adjustment to balance out the hum in the R.F. and 1:1-ratio audio stages. The filament circuits of the detector and the power tubes are automatically balanced by center-tapped windings. The receiver is of attractive appearance, and its operation, with regard to sensitivity, selectivity, quality, volume, and elimination of the A.C. hum, is satisfactory.

AWARDED THE RADIO NEWS

LABORATORIES CERTIFICATE OF MERIT NO. 2423.

## PHONOGRAPH PICK-UP

The "Via-Rad" phonograph pick-up device shown, submitted by the Brooklyn Metal Stamping Corp., 718-728 Atlantic Ave., Brooklyn, N. Y., is of the magnetic type and makes it possible to reproduce speech and music from ordinary phonograph records, when it is used in connection with an audio-frequency amplifier. It is of the balanced-armature type; the airgap between the pole pieces is adjusted in the factory before sealing. The magnets are of the bar type and situated on each side of the adjustable pole pieces in such positions that their fields assist. Their magnetic strength is great, resulting in a very sensitive and loud reproducer. The frame or base which supports the coil, armature, and pole pieces, the dimensions of which are  $1\frac{1}{2}$  x 2 inches, is cast



of aluminum alloy. The end of the balanced armature protrudes through the metal housing and carries at its end the socket and fastening screw for the phonograph needle. The device is fitted with a flange, designed to fasten over the tone arm of the phonograph after the usual reproducer has been removed. The over-all dimensions are  $2\frac{3}{8}$  inches long, 2 inches wide, and  $1\frac{1}{4}$  inches high; and the weight 8 ounces. The housing is of a gold finish.

AWARDED THE RADIO NEWS LABORATORIES CERTIFICATE OF MERIT NO. 2424.

## PICK-UP VOLUME CONTROL

The "Via-Trol" phonograph pick-up device volume control shown, submitted by the same manufacturer, is of the graphite-and-powdered-mica compression type; it has a resistance range from 0 to 500,000 ohms and is to be shunted across the terminals of the phonograph pick-up device. This resistor is provided with cord-tip jacks, two on each side of the housing; the tips of the pick-up are plugged into one pair of jacks, while those of the receiving-set adaptor are plugged into the other pair. The case or housing is of brown molded bakelite of pleasing appearance, the top is of gold-finished die-stamped metal, and the adjusting knob is molded of the same colored bakelite.

The diameter of the base is  $2\frac{1}{4}$  inches and the height over all  $2\frac{1}{2}$  inches. The device has proved satisfactory in giving smooth control of volume when used with the pick-up manufactured by the same concern.



AWARDED THE RADIO NEWS LABORATORIES CERTIFICATE OF MERIT NO. 2425.

## PHONOGRAPH PICK-UP ADAPTOR

The "Via-Tector" home broadcaster and pick-up adaptor device shown, submitted by the same manufacturer, is of the UX type and designed to be plugged into the detector socket of the radio receiver. If it is so desired, the detector tube may be plugged into the adaptor; thus utilizing this tube as an additional stage of audio frequency. Otherwise, the tube may be replaced by a jumper, which is plugged into the socket, thus allowing only the audio-frequency stages of the set to function. The device is of black molded bakelite and approximately



the size of the standard UX tube base; it is provided with a four-foot extension cord, the tips of which may be plugged into the volume control described above.

AWARDED THE RADIO NEWS LABORATORIES CERTIFICATE OF MERIT NO. 2426.

## A.C.-OPERATED RECEIVER

The "Model 801A" radio receiver shown, submitted by the Stewart-Warner Speedometer Corp., 1834 Diversey Parkway, Chicago, Ill., is of the all-electric type and operates directly from the 110-volt, 60-cycle house current. The receiver uses four 226-types, one 227-type, and one power tube, in three stages of tuned radio frequency, detector and two stages of audio frequency; the

power stage being of the 171 type. The "B" voltages are supplied by a full-wave rectifier of the 280 type, and smoothed well by an efficient filter system. The filament current is supplied by special windings on the power transformer. The compact tuning inductors are of the small-field type and located under the metal chassis. Four tuning condensers are arranged in tandem, with rotors fastened to a common shaft; the drum is calibrated in wavelengths as well as degrees, and controlled by a knob on the panel



of the set. A volume control is provided, which serves also as an oscillation control on the shorter wavelengths. The receiver is provided with connections for long or short aerials or, if preferred, the 110-volt line may be used as the antenna.

A cone speaker of the balanced-armature type, approximately 6 inches in diameter and enclosed in a metal housing, is attached to the cover of the radio receiver, making the receiver entirely self-contained. The housing of the set and speaker is finished in a brown crystalline finish. The combination is small in size, but was found to be satisfactory in regard to sensitivity, selectivity, quality and volume.

AWARDED THE RADIO NEWS LABORATORIES CERTIFICATE OF MERIT NO. 2427.

**VACUUM TUBE**

The "Type 01B" vacuum tube illustrated, submitted by the C. E. Manufacturing Co., Inc., 702 Eddy St., Providence, R. I., has the same general characteristics as the 201A



tube, which it may be used to replace when provision is made for the lower filament consumption of 1/8-ampere (125 milliamperes) at 5 volts. The amplification constant (taken from a set of four tubes) is approximately 9, with a plate impedance at 90 volts of approximately 10,000 ohms. The tube is equipped with a standard UX base and its operation as a detector or amplifier is found to be as satisfactory as that of the 201A-type tube.

AWARDED THE RADIO NEWS LABORATORIES CERTIFICATE OF MERIT NO. 2428.

**A.C.-OPERATED RECEIVER**

The "Metrodyne" eight-tube radio receiver shown, submitted by the Metro Electric Company, 2171 No. California Ave., Chicago, Ill., is of the electric type, using 6-volt D.C.

tubes, and operates directly from 110-volt, 60-cycle current. The "A" current is supplied by a step-down transformer from the A.C. line to a rectifier of the dry type. The

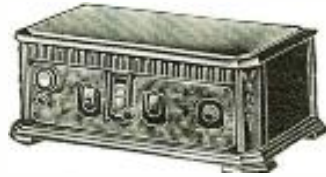

low-voltage, pulsating uni-directional current is then properly filtered until all trace of A.C. hum has been eliminated. A voltmeter and rheostat are provided, so that the filament voltage may be adjusted and maintained at the proper value. The "B" voltages are supplied by a full-wave gas-filled rectifier tube in connection with the necessary filter system. Three stages of tuned radio frequency with shielded coils are employed for selectivity and sensitivity. The oscillation control is placed on the panel so that maximum sensitivity may be obtained at all wavelengths. A tuned detector is followed by two stages of 1:1-ratio audio frequency of the conventional type which feed the amplified impulses into a stage of push-pull amplification of the 171 power type.

The speaker windings are protected by an output choke of balanced type. The tuning of the R.F. and detector circuits is accomplished by one control of the drum-scale type, which operates the common shaft of the condenser rotors; fine adjustment is obtained on the tuned circuits by the operation of levers protruding through the panel on either side of the tuning control. The receiver has an attractive appearance, and its operation with regard to selectivity, quality and volume is satisfactory.

AWARDED THE RADIO NEWS LABORATORIES CERTIFICATE OF MERIT NO. 2429.

**A.C. VACUUM TUBE**

The "No. 22" vacuum tube shown, submitted by the Arcturus Radio Company, 255 Sherman Ave., Newark, N. J., is an A.C. screen-grid tube of the indirect-heater type, employing a cathode emitter which is heated by a filament of carbon, whose filament consumption is 0.35-ampere at 15 volts. An amplification of 400 at 1,000 cycles was obtained with the sample submitted for test; with 135 volts on the plate, 1 1/2-volt "C" bias on the control-grid, and a shield-grid voltage of 45, and using a plate load of 1 megohm. An amplification of from 25 to 60 at radio frequencies was obtained with output coupling impedances of different types. The measured conductance at 1,000 cycles was found to be approximately 445 micromhos, the plate impedance 900,000 ohms. The tube may be used successfully



as an A.C. screen-grid R.F. or A.F. amplifier tube, a space-charge or screen-grid detector, or a space-charge audio amplifier.

AWARDED THE RADIO NEWS LABORATORIES CERTIFICATE OF MERIT NO. 2430.

**NEON TELEVISION TUBE**

The "Telion" neon tube illustrated, submitted by the K. & H. Electric Corp., 68 Springfield Ave., Newark, N. J., is designed especially for television work. Its "striking voltage" as measured, was found to be approximately 180 volts, the current at the "dark point" 11 milliamperes. The recommended safe average current is 50 milliamperes, although the maximum current may reach 125 milliamperes. The tube gave a uniform glow and did not become spotty with changes of current at high frequencies. It is fitted with a base of the UX



type. The glow electrode has a surface 1-7/16 inches square, and is made of a special material to promote uniformity of glow with very small currents.

AWARDED THE RADIO NEWS LABORATORIES CERTIFICATE OF MERIT NO. 2431.

**MICA BALANCING CONDENSER**

The "Micrograd" small adjustable balancing condenser, submitted by the Pilot Electric Mfg. Co., 323 Berry Street, Brooklyn, N. Y., is of the mica-dielectric type, designed for neutralizing or compensating radio-frequency circuits. It was found to have a variable capacity range between 6 to 50 micromicrofarads. The variation is accomplished through adjustment of the small



knob, either by hand or by the use of a screw-driver; this compresses or loosens the curved spring-brass plates, which are separated by mica, thus increasing or decreasing capacity. The housing is of black molded bakelite and requires a sub-panel or base-board space 2 x 1 1/4 inches. The overall height, with the adjusting screw at minimum capacity, is approximately 1 1/4 inches.

AWARDED THE RADIO NEWS LABORATORIES CERTIFICATE OF MERIT NO. 2432.

**SPEAKER CONTROL SWITCH**

The loud-speaker control switch shown, submitted by the Fisch Radio Company, 1283 Hoe Ave., Bronx, N. Y., allows the listener to operate either of two speakers separately or both simultaneously, connected in series. This is advantageous when a speaker designed for reproduction of high notes and one designed for reproduction of low notes are used together. It is of black molded bakelite, 2 3/4 inches long, 1 1/4 inches thick and 2 3/4 inches high. On its curved top are found four holes for the insertion of the tips of the

speaker cords. One terminal of each speaker is inserted in one of the holes marked 2, while the remaining two terminals of the speakers



are connected into the holes marked 1. The internal construction is that of a double-pole, double-throw rotary switch; contact springs are arranged along the top of the switch mounting to receive the ends of the cord tips, which pass through the molded housing. The operation of the switch was found to be satisfactory for the use designed.

AWARDED THE RADIO NEWS LABORATORIES CERTIFICATE OF MERIT NO. 2433.

**PLUG-IN COIL FORM**

The "plug-in coil" form shown, submitted by Silver-Marshall, Inc., 846 W. Jackson Blvd., Chicago, Ill., is of the UY- or 5-prong-type, designed to be plugged into any UY socket. Its over-all height is 2 1/2 inches and it provides 1 1/2 inches winding space on a tube 1 1/2 inches in diameter. The secondary winding space is threaded with 75 turns



to the inch, which allows the construction of a space-wound plug-in coil of modern design. The lower end of the form is provided with a slot 1/16-inch wide and 1/8-inch deep for a primary or tickler winding of the bunched type. The five prongs provide for the use of the coil as a short-wave three-circuit coupler, when the filament and ground ends of the secondary and primary are made common to the cathode prong. The form is molded of black bakelite and provided with a reinforced rim at the top, to prevent damage to the completed coil when removed from the plug-in socket.

AWARDED THE RADIO NEWS LABORATORIES CERTIFICATE OF MERIT NO. 2434.

**SCREEN-GRID A.F. COUPLING UNIT**

The "Type-223 Hi-Mu" audio transformer shown, submitted by the same manufacturer, has been de-



signed as an output coupling device for a screen-grid tube or other hi-mu vacuum tube. It pro-

(Continued on page 507)



Conducted by C. W. Palmer

RADIO NEWS readers send in every month an average of 5000 letters asking information on every phase of radio theory, construction and operation. We can only print the five or six replies which are of widest general interest. Other letters will be answered by mail, if inquirers observe these rules: BE BRIEF: TYPEWRITE OR WRITE LEGIBLY IN INK ON ONE SIDE OF THE SHEET ONLY: ENCLOSE A STAMPED ENVELOPE ADDRESSED TO YOURSELF. Many letters are not readable. Simple questions will be answered free;

those asking for sketches, diagrams, data, etc., should send TWENTY-FIVE CENTS FOR EACH QUESTION: failure to enclose this will cause delay. We cannot answer for this sum questions requiring original research, intricate calculation, or patent investigation; we cannot compare the merits of trademarked apparatus, or give constructional data on apparatus whose makers withhold it. We cannot undertake to answer more than THREE QUESTIONS in each letter. If you inquire concerning a circuit which is not a standard, published one, enclose a diagram to save delay.

BY-PASSING AUDIO AMPLIFIER

(2307) Mr. R. W. Wilson, Portland, Maine, writes:

(Q.) "I understand that most audio-frequency amplifiers can be improved by the correct use of by-pass condensers. Can you explain where these condensers should be used, their values, and just what advantage they supply to an amplifier of this type?"

(A.) Audio-frequency amplifiers are often constructed in such a way that a common coupling is unavoidably formed by the power unit or common "B" battery. This coupling provides an excellent path for feed-backs, from which a large amount of distortion may result. This trouble may be reduced very easily by the proper use of by-pass condensers between the various circuits. These condensers provide a lower resistance path for the audio-frequency currents than the artificial coupling. Of course, the direct current passes through the usual circuits, since it is blocked by the condensers. You will find two diagrams showing how by-pass condensers should be used in an audio-frequency amplifier in Figs. Q. 2307A and B. The first represents any audio-frequency amplifier with transformer coupling, resistance coupling, or any type of "impedance" coupling. Condenser C1 is the usual by-pass condenser connected between the plate of detector V1 and the negative filament. The plate circuit of each amplifier tube is completed by connecting a 1-mf. by-pass condenser between one of the filament terminals and the positive "B" terminal of the transformer. These condensers are shown at C3 and C5. A separate path is also provided for the grid currents by placing by-pass condensers of 1/4-mf. or more capacity between the transformer secondaries and the filament terminals. These condensers are represented at C2 and C4.

The diagram in Fig. Q. 2307B represents the usual transformer-coupled audio-frequency amplifier and shows how the by-pass condensers should be

connected in order to improve the results. The condensers should be placed close to the transformers, so that the audio-frequency currents will not have to travel through much of the wiring in the amplifier or through any of the leads to the power units.

REDUCING THE HUM IN A.C. SETS

(2308) Mr. B. Brown, Miami, Florida, writes:

(Q.) "I am constructing a receiver with two stages of radio-frequency amplification and two of audio-frequency amplification, using the 226 tubes in the radio-frequency and first audio-frequency positions, and a 227 in the detector and a 171 in the

The voltage on the filament alternates, except at its center, which is a "node" or point of uniform potential. On the "Wheatstone bridge" principle, a resistance shunted across this must contain a point of identical voltage, located by the sliding arm.

last audio-frequency stage. I am rather puzzled about the grid returns and the methods of keeping the A.C. hum at a minimum. Can you give me any data on this subject?"

(A.) The method of balancing out the audio-frequency noises in an A.C. receiver is a rather puzzling problem for the average radio fan. The usual method of connecting the grid return directly to one side of the filament supply circuit is not sat-

isfactory with A.C. sets, since it unbalances the filament circuit and introduces a considerable hum. The grid returns for the 226 tubes may be connected according to several easy methods. The balancing consists merely of finding the exact electrical center of the filament circuit, so that no alternating voltage from the power supply will be impressed on the grid. Naturally, since this current is an alternating one, it must be kept entirely out of the grid circuit.

Three methods of obtaining the electrical center of the filament circuit are shown in Fig. Q. 2308A,

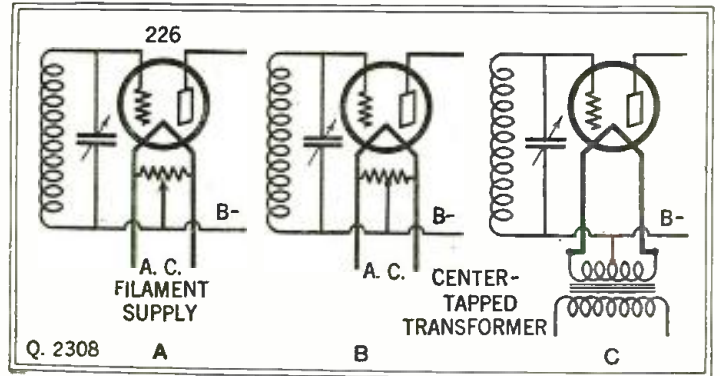

B and C; these methods are the most common in use at the present time. Fig. A shows the use of a resistor with a sliding contact which can be adjusted for the minimum amount of hum. This resistor usually consists of a potentiometer of about 15 ohms shunted across the center of the filament transformer. This method is a very good one, since it is often found that the actual center of the filament circuit is slightly to one side of the theoretical center.

Fig. B is similar to Fig. A except that a fixed center tapped resistor is used. This method is not quite as efficient as the one shown in Fig. A, since if the center tap of the resistor does not balance the secondary of the power transformer in reference to the ground, the filament circuit will be unbalanced. However, in most cases it is very satisfactory. Another method is shown in Fig. C, which has the same defect as the method shown in Fig. B. This method employs a center tapped filament transformer for the filament supply, but is also very satisfactory for general uses.

It is best to use a separate resistor for each grid return rather than try to use one resistor for all of the tubes, since in this way, each tube is balanced in respect to its own filament circuit. The wiring to the filament circuits of the A.C. tubes should be done with twisted wires, well insulated and kept as far away from the grid circuits as possible. This wire must be quite heavy (No. 14 at least), to pass a considerable current.

The use of resistors for the grid returns of tubes in a radio-frequency amplifier sometimes results in instability or oscillation in the amplifier. However, this difficulty can easily be overcome by connecting fixed condensers between the center tap of the resistor and each side. These condensers should have a value of .005-mf.

Grid Bias

This is another point which causes considerable confusion in the construction of A.C. receivers. When the negative grid bias for the radio-frequency

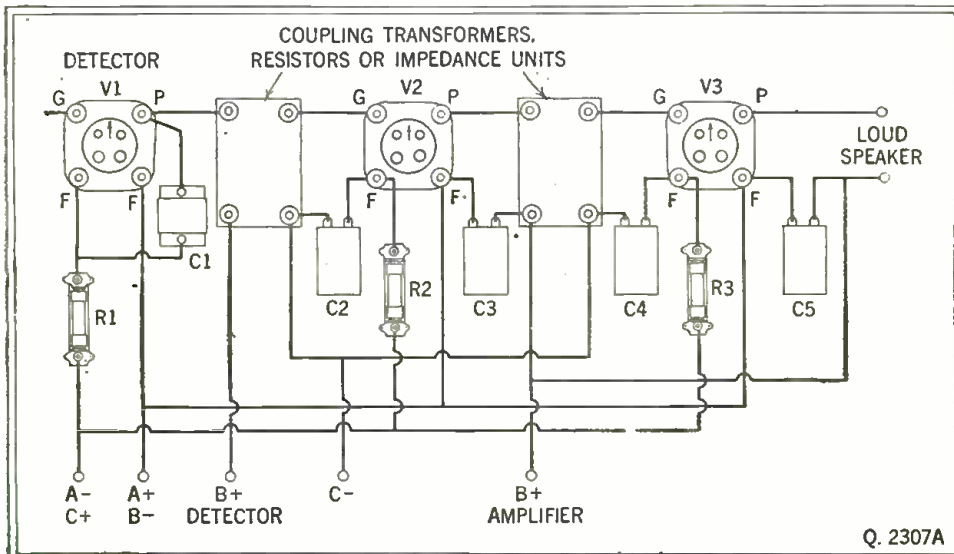

Alternating impulses are kept out of the "B" battery, which is common to all circuits, by the use of suitable condensers which divert them to the grounded filament. C1 is an R.F. by-pass; C2 and C4 block the "C" voltage, and C3 and C5 the "B" voltage from the filament while completing the A.F. circuits.



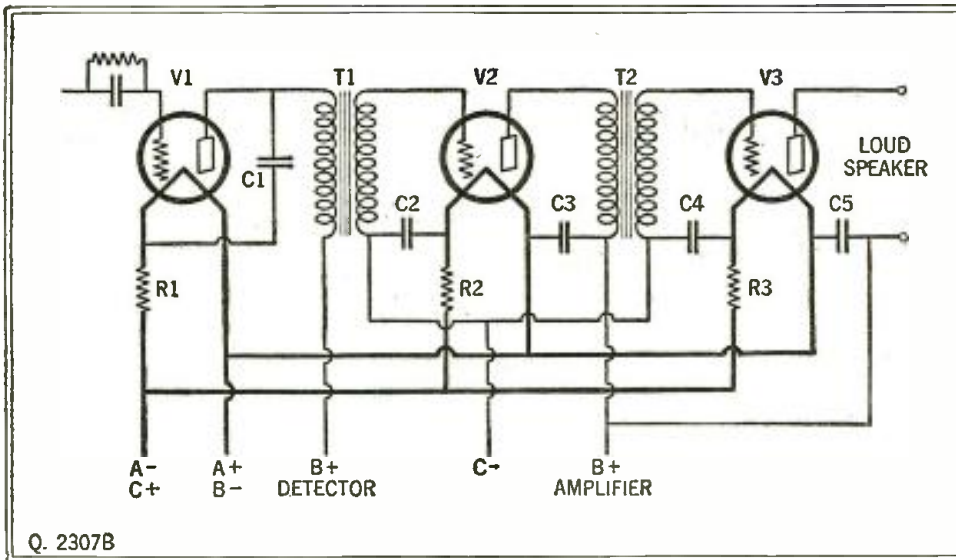

Q. 2307B

Schematic circuit of the arrangement in Fig. Q. 2307A when transformers are used. C1 may be from .001-mf. up; C2 and C4 are usually 0.25-mf., C3 and C5, 1 mf., though such values are not critical.

amplifier and audio-frequency amplifier tubes in an A.C. set is to be obtained from the "B" power unit, a separate resistor may be used to supply the voltage to each grid or one common resistor with the correct taps may be used for the complete supply. When 226 tubes are used in a radio-frequency amplifier, the plate voltage should be 135 volts and the negative bias 9 volts, in order to give the greatest amplification and the quietest operation. Because each of the tubes requires the same bias, a single resistor can be used for all of the tubes. The method of connecting this resistor is shown in Fig. Q. 2308D. It will be noticed that the center filament terminals of these amplifier tubes are connected to one side of resistor R1, while the other side and the grid returns connect to ground and to the negative "B" battery terminal.

The value of resistor R1 can be easily determined with the aid of Ohm's Law, wherein R equals E divided by I. R represents the unknown resistance required, E represents the biasing voltage, and I the plate current of the tubes for which the grid bias is required. To give the least amount of hum, the plate current should be 3 milliamperes and the plate voltage 135 volts, for each tube. The correct value of the "C" bias for this plate voltage and current will be found to be 9 volts. If we have three 226 tubes requiring "C" bias, the total plate current will be 9 milliamperes, or .009 ampere. Substituting these values in the equation given above; R equals 9 divided by .009, or 1,000 ohms, which is the correct value for the resistor R1. The condenser C6 in the diagram is used to by-pass the radio-frequency currents around resistor R1. This condenser should have a value of about 1-mf.

**THE INSTITUTE OF RADIO ENGINEERS**

(2309) Mr. A. T. Kenny, Spokane, Washington, writes:

(Q.) "I have frequently encountered the letters I.R.E. in electrical and radio publications and I have wondered just what the Institute of Radio Engineers was founded for and what their aims are. Of course, I realize that every large engineering profession has its society; but I am particularly interested in this Institute and I would appreciate any information that you can give me."

(A.) We have received a number of inquiries about this society, and because we believe that the data will be of interest to a number of our readers, we are reprinting part of the information contained in the 1928 Year Book of this Institute.

"The Institute of Radio Engineers functions solely to advance the art and science of radio communication. It numbers among its members nearly all of the men who have been prominent in the development of radio in the United States, as well as many noted engineers and scientists in other countries.

"The membership of the Institute consists of those persons who are qualified for any of its several grades of membership, either through their interest in radio communication, or by practice of some phase of radio engineering as a profession. The eligibility of an applicant to membership in any grade is finally determined by the Board of Direction of the Institute, in most cases on the recommendation of the Committee on Admissions.

"Through the presentation and publication of original papers, by affording its members the opportunity of meeting to discuss radio problems, by awards of honors and prizes, and in other ways, the Institute fosters and encourages the develop-

ment of this important means of communication, and particularly aids in the exchange of radio information of a technical and engineering nature."

**Membership**

"There are four grades of membership in this Institute; namely, Fellow, Member, Associate and Junior. All the benefits of membership are available at once to all new members of any grade, except that Juniors are not eligible to vote. Membership means, also, that one is enrolled with others having a similar interest in radio, and that one is on record as being among those who are interested and active in the development of this new and useful branch of the engineering industry.

"The grades of Fellow and Member require a much higher degree of technical training and experience than the grade of Associate. In order to maintain a high standard of membership, the Board of Direction in each case very carefully scrutinizes the applications for Fellow and Member grades.

"Before applying for membership in any grade the applicant should carefully read the Constitution of the Institute to ascertain for which of the several grades he is eligible. An extract from the Constitution dealing with admission, eligibility, fees, etc., is printed on the back of the application form obtainable from the Institute's headquarters. When filling in the application form, the applicant should submit the names of those persons who have knowledge of his professional experience, rather than those who have a high professional standing, but cannot vouch for him."

**History**

"Prior to the formation of the Institute of Radio Engineers, two other organized groups of radio enthusiasts held meetings in New York and Boston. These were the Wireless Institute and the Society of Wireless Telegraph Engineers. On May 13, 1912 these two organizations were merged, taking the new name of the Institute of Radio Engineers. Headquarters were established in New York. The Society of Wireless Telegraph Engineers had a membership of eleven in 1907 and forty-three in 1912. The Wireless Institute had fourteen members in 1909 and twenty-seven in 1912. The Institute of Radio Engineers, at the time of its foundation, had less than fifty paid-up members." Its membership is now about five thousand, four-fifths of them in the United States.

Application blanks and information can be obtained by addressing the Secretary of the Institute at the Engineers' Building, 33 West 39th Street, New York City.

**ELECTROLYTIC "B" POWER UNIT**

(2310) Mr. H. A. Wilkins, Cleveland, Ohio, writes:

(Q.) "Will you please supply me with instructions for making an electrolytic "B" power unit to operate on the 110-volt 60-cycle electric-light line? I do not wish to use a transformer in this unit as I require only about 90 volts for the radio-frequency and detector tubes in my receiver. I am using a power pack with an audio-frequency amplifier, but the rectifier employs a 216B tube and will not supply sufficient current for the rest of the set."

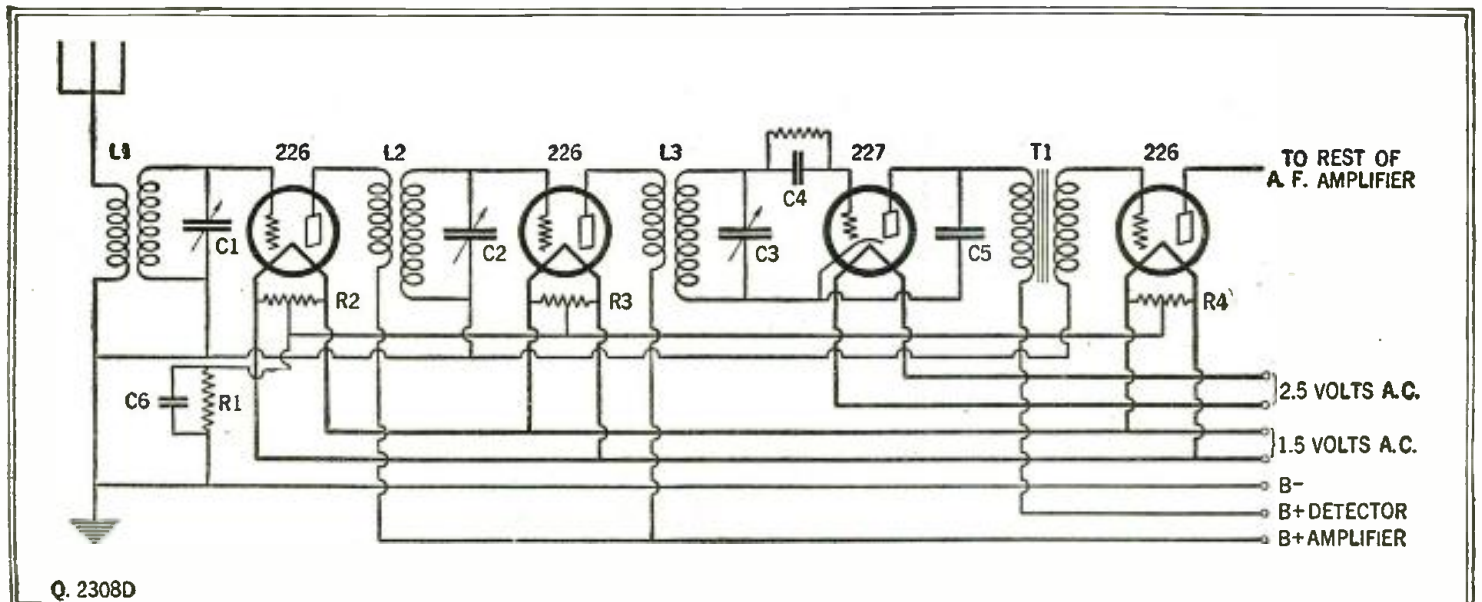

Q. 2308D

A typical A.C. hook-up; the value of resistor R1 depends on the plate current of the two R.F. amplifiers and the first A.F. amplifier, which it biases. It keeps the center points of the filaments at, say, 9 volts above ground, to which the grid leads return. In the last stage a resistor must be used, of

value suitable to maintain the higher bias on the power tube. The floating circuit of the detector, which uses a grid leak and condenser, is based on the cathode of the 227 tube. The value of the resistors R2, R3 and R4 is negligible in computing the voltage drop.

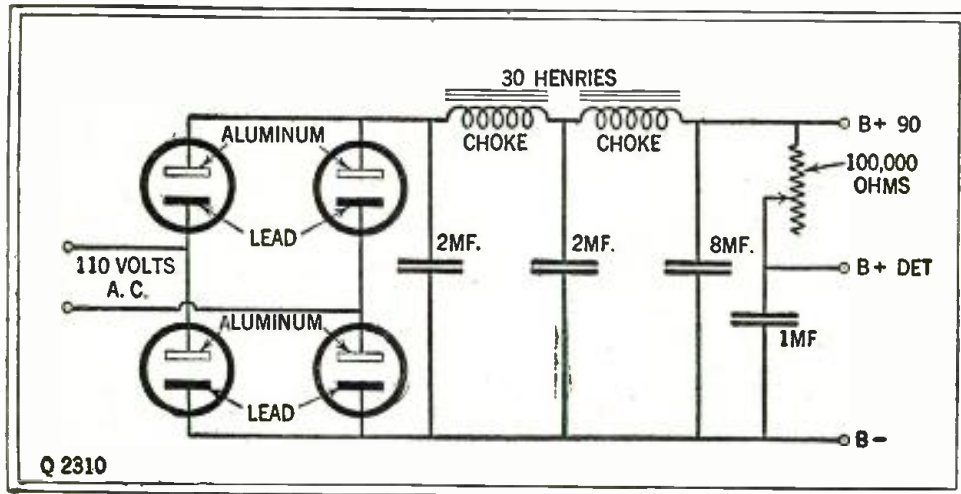

Connections of a simple electrolytic rectifier, which will furnish up to 90 volts "B" supply without the use of a step-up transformer. The variable resistor regulates the detector voltage to any desired amount.

(A.) You will find the diagram of a power unit of this type in Fig. Q. 2310. Four electrolytic rectifier jars are used, and two 30-henry chokes with three filter condensers comprise the filter system. The rectifier plates are made by cutting strips of pure aluminum and lead, 2 inches wide and 5 inches long. The aluminum plates are made of 1/8-inch extra pure or No. 1 commercial stock; you can obtain this from any good metal dealer or hardware company.

Bend the plates over at a right angle, one inch from one end. Then hang them over the tops of the cells, which consist of four pint mason jars. Make the electrolyte by dissolving as much primary (acid) ammonium phosphate as possible in two quarts of distilled water. Add crystals until there is an excess which will not dissolve. Then pour off the liquid and place it in the jars. Next insert the aluminum and lead plates into the solution and connect them as shown in diagram Q. 2310.

Before using the "B" power unit, the plates must be "formed." Connect a 25-watt electric-light bulb across the rectifier, in place of the first 2-mf. condenser, and leave the rest of the apparatus disconnected. This will place the bulb across the rectifier and will supply the necessary load. Next, connect the input or alternating current wires to the electric-light line and let the unit run for about 5 or 6 hours. This will be sufficient to "form" the plates and you can connect the condensers and chokes as shown in the diagram. High-voltage condensers are not required here.

The output of the power unit will supply about 90 to 100 volts, depending on the resistance of the choke coils. This is usually too great for the detector tube, so that a variable resistor (a regular 100,000-ohm carbon-type) is provided to reduce this voltage to the correct value. A 1-mf. condenser is also connected between the detector tap and the "B—" terminal of the unit, to keep the output steady and by-pass any stray radio-frequency currents.

In order to obtain satisfactory results with an electrolytic "B" power unit, you must use pure metal for the aluminum electrode and chemically pure ammonium phosphate for the electrolyte. Also use only distilled water, to be sure that it is pure. By pouring a layer of mineral oil over the surface of the electrolyte, evaporation will be reduced considerably; and this will also prevent sparking at the surface of the liquid to some extent. If the sparking is excessive, insulate the tops of the aluminum electrodes by placing rubber tubes over them or by coating them with celluloid dissolved in acetone.

**SIMPLE ONE-TUBE SET**

(2311) Mr. M. J. Lynch, Portland, Maine, writes:

(Q.) "I am a beginner in radio and, although I have constructed several crystal sets, I have never attempted to build a tube set. I have been a reader of your publication for almost a year, so I am more or less familiar with the terms used in radio. I have looked over all the back issues that I have on hand, but I do not find a suitable set for my purpose. The receiver that I desire to build is one using a single tube. I do not like to make a set that would interfere with my neighbors, so I do not want a regenerative receiver; I want to get the greatest efficiency, though. Will you give me the diagram and specifications of a suitable set?"

(A.) We are printing the diagram of a single-tube reflex set, using a crystal detector, herewith.

(See Figs. Q. 2311 A and B.) The parts required for the set are as follows:

- One 201A- or 199-type tube (V1);
- One tube socket;
- Two .0005-mf. variable condensers (C1, C2);
- One audio-frequency transformer, about 3-1 ratio (AFT);
- One crystal detector (CR);

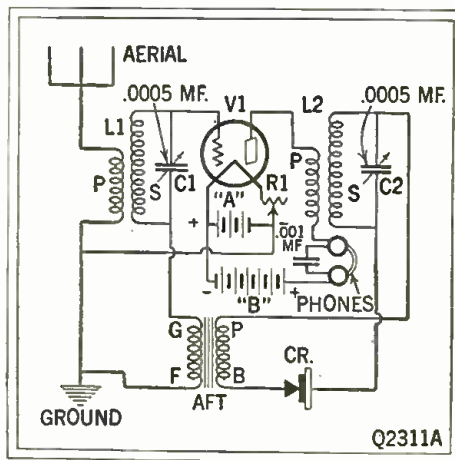

This one-tube reflex circuit furnishes the maximum amplification available without making a "blooper."

- One 20- or 30-ohm rheostat, depending on whether a 201A or 199 tube is used (R1);
- One .001-mf. fixed condenser (C3);
- Eight binding posts;
- One 7 x 12-inch panel;
- One 8 x 12-inch baseboard, 1/2-inch thick;
- Two 3-inch tubes 3 inches long for coils;
- No. 22 D.C.C. wire; screws; wire for connections, etc.

The first point in constructing the set is to make the coils. The aerial coupler is wound with 12 turns of No. 22 double-cotton-covered wire for the primary and 48 turns for the secondary. The primary is wound on one end of the coil and a space of 1/4-inch is left before the secondary is wound on. Both of the coils are wound in the same direction. The second R. F. coil (L2) is made the same as the first coil (L1), except that the primary contains 15 turns. In the aerial coil, the end of the secondary farthest away from the primary is connected to the grid of the tube. In the second coil, the outer end of the primary is connected to the plate of the tube.

The next step in building the set is to drill the panel for the condensers and rheostat. Place the parts approximately in the positions shown in Fig. Q. 2311 B. The positions of the holes depend on the particular apparatus employed and will have to be determined when the parts have been bought. After the panel has been drilled and these parts have been mounted on it, mount the other apparatus on the baseboard in the positions shown. Fasten the binding posts either directly to the baseboard or to small strips of hard rubber or bakelite mounted on the baseboard. Then wire the set according to either diagram, Fig. Q. 2311 A or Fig. Q. 2311 B, as you find easiest, and check every connection. The connections to the audio-frequency transformer are indicated on both diagrams; although it may be found necessary to reverse the connections to the secondary coil in order to get the best results.

The values of the "A" and "B" batteries depend on the type of tube used. If a 201A is employed, the "A" battery must be a 6-volt storage battery; while, if a 199 is used, three dry cells connected in series will be sufficient. To put these batteries in series, connect the center terminal of the first battery to the outer terminal of the second. Then connect the center terminal of this battery to the outer terminal of the third battery and the two remaining terminals to the set. The center terminal of each cell is the positive ("+" ) and the outer one is the negative ("—" ).

The "B" battery should have a voltage between 45 and 90, for either type of tube, and since the current consumption is rather low, the small dry-cell batteries can be used.

**Operation**

The set is now ready for operation. Adjust the rheostat R1 until the tube lights up with its normal brilliancy; in a 201A tube, this will be quite bright, while only a dull red glow will be noticed. (Continued on page 505)

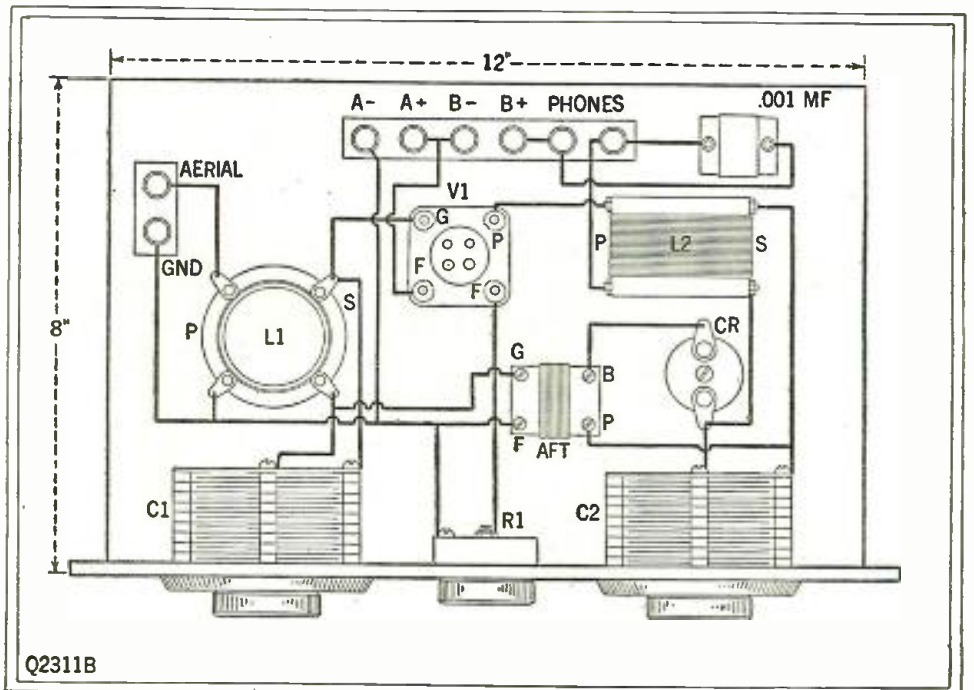

The single-tube reflex circuit of the diagram above is shown here in pictorial form; the simplicity of the hook-up can be seen. The crystal detector may be of any type preferred; a Carborundum unit gives excellent results and requires little adjustment. This unit works with phones only; but an amplifier such as the "Extension" may be added to operate a loud speaker.

# New!

## WONDERFUL RADIO!

### Super-Eight—100% Electric 8 TUBES—SINGLE DIAL Coast-to-Coast

Shipped Direct from our Factory on

## 30 Days Free Trial

[ Battery or Electric ]

Now comes Metro's latest achievement—the world's greatest electric radio set—a powerful long distance eight tube receiver—clearness of tone that is astounding—ultra-selective—a set that expert radio engineers have pronounced as the ultimate for all around perfection. And to prove our claims, we will send this marvelous set to you direct from our factory on 30 days' free trial. Test it to your heart's content. Compare its quality, beauty and price with any other radio on the market, and decide to keep it only after you are satisfied that the new 1929 Metrodyne super-eight is the peer of them all.

# Metrodyne

**SUPER-EIGHT ELECTRIC**

### Save One-Half—Low Price a Big Feature!

You will be amazed at the low price of these wonderful sets, in the console or table cabinet. Our low cost of distribution direct from our factory enables us to save you about half their regular value. Never before in radio history have you been offered such sets at such low prices. And we are so sure of their quality, beauty and performance pleasing you that we do not hesitate to let you try one for 30 days before deciding to keep or return it.

### SUPER QUALITY THROUGHOUT!

Eight powerful tubes. Highest quality low loss parts. Illuminated single dial. Positive switch control—simply turn a knob and it's on. Select your stations with accuracy at any desired volume. Beauty of tone that cannot be surpassed. Console and table cabinets are handsomely grained genuine walnut, hand rubbed, in two-tone effect—artistically carved trimmings. All metal parts finished in two-tone gold. Seeing is believing. You will be the judge.



Georgious console with newest type, built-in sonorous loud speaker that reproduces the entire range of vocal and instrumental music. Amazingly clear and distinct. Low, direct-from-factory price on **30 DAYS' FREE TRIAL!**

### AGENTS and DEALERS

The 1929 Super-Eight line offers great money making opportunities. Nothing like them for high quality—nothing near them in price. Let us prove this by shipping you a

**Demonstration set on 30 days' free trial**

Test it—compare it—demonstrate it to prospective radio buyers. Get our liberal discounts—exclusive territory—newspaper and billboard advertising offer that will help you sell Metrodyne radios quickly.

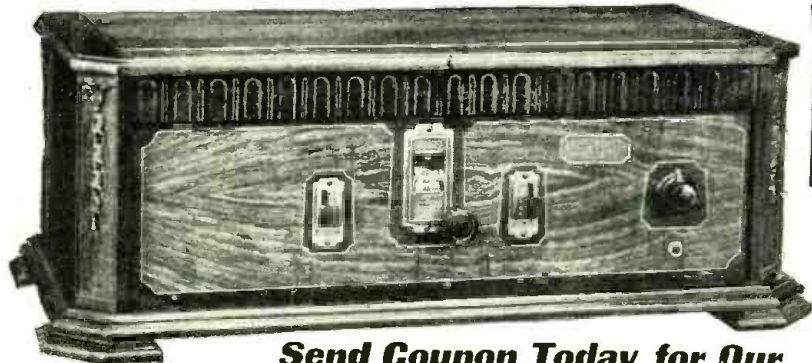

Send Coupon Today for Our  
**30 Days' Free Trial Offer** →

**METRODYNE  
RADIO SETS  
Are Equipped For  
BATTERY or  
ELECTRIC  
OPERATION**

We are one of the pioneers of radio. The success of Metrodyne sets is due to our liberal 30 days' free trial offer, which gives you the opportunity of trying before buying. Thousands of Metrodynes have been bought on our liberal free trial basis. We will send you hundreds of letters from owners who acclaim the Metrodyne as the greatest radio set in the world. A postal letter or the coupon brings complete information, testimonials, wholesale prices and our liberal 30 days' free trial offer—**WRITE TODAY!**

**METRO ELETRIC COMPANY**  
2161-71 N. California Ave., Dept. 12  
Chicago, Illinois

Gentlemen:  
Send me full particulars about Metrodyne Super-Eight sets and your 30 days' free trial offer

Name \_\_\_\_\_  
Address \_\_\_\_\_

If you are interested in AGENT'S proposition, place an "X" in the square →

**METRO ELECTRIC COMPANY**  
2161-71 N. California Ave. • Dept. 12 • Chicago, Illinois

Please say you saw it in RADIO NEWS

# How to Make Your Own Television Receiver

(Continued from page 425)

hook-up, incidentally, it is a good idea to shunt the glow-lamp by a 0-10,000-ohm variable resistor; this resistor should be so set that the tube lights nicely when there is no incoming signal. The 171A draws about 20 milliamperes, which is the normal load limit of the glow-lamp; so the combination works out very happily.

### TRY YOUR LUCK

Remember that television as we have it to-day is very crude. Do not expect perfect images, and do not forget that television on 5,000 cycles was, until only very recently, held impossible altogether. Experiment with the

To receive the Jenkins radio movies, on 46.7 meters, you can use this same apparatus with the disc speeded up to 900 r.p.m. These "movies" are black and white silhouettes, usually of a little girl bouncing a ball, or playing with a dog.

Next month we will publish more television "dope." Meanwhile, try your luck with this receiver; you will have a lot of fun with it.

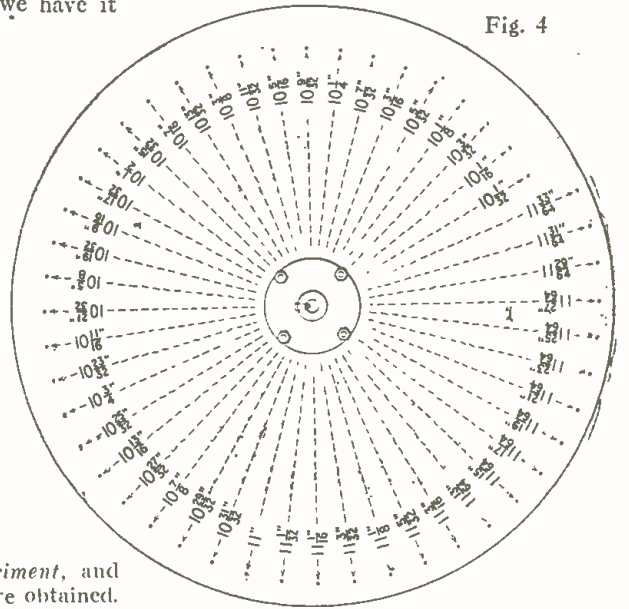

Fig. 4

Drilling layout of the 24-inch disc used. A full-size template accompanies the blueprints—if you wish to try your luck making your own.

neon tube and the motor's speed and try different output arrangements. Try putting an ordinary reading glass in front of the images, as shown in the cover illustration, and see if you can magnify them. Experiment, and let us know what results you have obtained.

READERS will find interest and probable profit in the article, "How to Build the 'S & I' Television Receiver," in the November issue of SCIENCE AND INVENTION Magazine. This receiver may be readily built upon a fan motor, like the experimental set-up described in RADIO NEWS for September; and employs a very simple, but ingenious, visual ("stroboscopic") method of determining its speed and obtaining synchronism.

## Televentures, Telewitticisms and the Televocabulary

(Continued from page 419)

within a generation to broadcast to a whole nation such sights as a Reinhardt 'Miracle' or a tennis match. The optimistic American regards the surmounting of obstacles as the very essence of invention, and rightly. One has but to read the Federal Trade Commission's examination of radio patent monopolies to learn of the romance that lies in vaulting over technical obstacles—of fortunes paid to young engineers who made it possible for a farmer in carpet slippers to enjoy the Philharmonic Orchestra better than in a hard-boiled shirt in Carnegie Hall. To an inventor of imagination the difficulties that now beset the commercial realization of television are glittering opportunities, and it is in that spirit that they will be conquered."

### WHAT OF THE DICTIONARY?

With the vocabulary of even radio broadcasting quite out of the hands of the engineering profession, what is the puzzled maker of dictionaries to do about the new words which the art of television will require? The "glow lamp" and "scanning disc" may be soon used only in the past tense; but what shall we call the apparatus required for the transmission and reception?

Will both be "televisors"? And if not, which?

"Television" is a word on which the language sharps look askance; like "automobile," it is a hybrid—half Latin and half Greek—and the public has even less Latin than the Bard of Avon, and no Greek. The editor of RADIO NEWS, before the days of broadcasting, coined "television," and suggested for the apparatus "telephot," which is a better word from the dictionary standpoint than "televisor." Will we use "phots" or "visors"? An English writer has hinted of "teleopsis" and "teleoppers," to be shortened into "oppers"; but this seems to lack the necessary seriousness to convince.

What will be the title of the operators? We have "radiotricians" as specialized electricians: we will need a word of the weight of "televisticians," which may do for the present. But a "visionary engineer" seems impractical.

Television transmissions require modulating frequencies, increasing with the size and detail of the image. While small figures suitable to the experimental receivers of the day are being reproduced from audio frequencies, the larger images of tomorrow will require wider hands and special amplifiers. These will be specially designated: "image-



Look for the



on top of all

**Cunningham**  
RADIO TUBES

WHEN you look inside of your radio, be sure you see the monogram "C" smiling up at you on the top of each radio tube.

Thirteen years of experience and tireless research, combined with a guarantee against mechanical and electrical defect, stand behind this simple monogram.

Cunningham Tube quality has resulted in national leadership and public approval, two assets we zealously guard, and is your assurance of faultless modern reception.

Never use old tubes with new ones—use new tubes throughout

E. T. CUNNINGHAM, INC.  
New York Chicago  
San Francisco

Manufactured and sold under rights, patents and inventions owned and/or controlled by Radio Corporation of America.

**Cunningham**  
RADIO TUBES

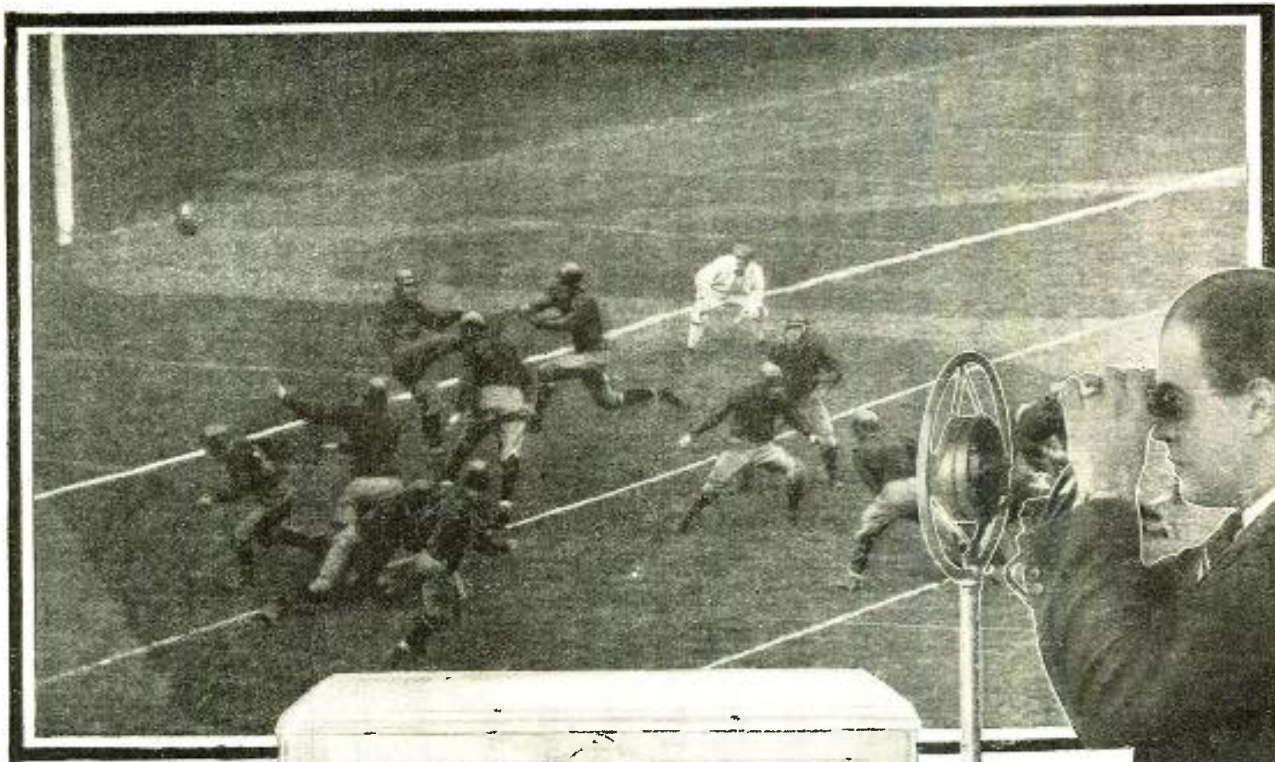

The broadcast of the Army-Navy game last year was enjoyed by hundreds of thousands of fans all over the country.

Phillips Carlin broadcasting at one of the big football games.

# The Big Game Comes Over~ BETTER~CLEARER

**M**ILLIONS of enthusiastic football fans are listening this fall to the play by play broadcasts of America's greatest games. They are experiencing almost as keen enjoyment as if they were sitting in the stands. The voice of the announcer comes to them clearly and distinctly because their receiving sets are Aluminum equipped.

Leading radio manufacturers are using Aluminum extensively for shielding, for condenser blades and frames, for chasses, sub-panels, front panels and for many other parts—because Aluminum so ideally meets the varied conditions that radio design presents.

It combines remarkable shielding properties, high electrical conductivity, great strength and extreme lightness.

Examine the set you contemplate buying. If it is Aluminum equipped you may rest assured that the manufacturer has done everything in his power to give you the finest possible reception.

And if you are building a receiving set use Aluminum for finest results.

We will gladly send you the booklet, "Aluminum For Radio," which explains the varied radio uses to which Aluminum is adapted.

**ALUMINUM COMPANY OF AMERICA**  
ALUMINUM IN EVERY COMMERCIAL FORM

2467 Oliver Building  
Pittsburgh, Pa.



Offices in 19 Principal  
American Cities

# ALUMINUM

*The mark of Quality in Radio*

Please say you saw it in RADIO NEWS

# The New Victoreen A. C. Circuit

*Is the Outstanding  
Success of the Year*



Vital improvements in Victoreen R. F. Transformers, together with changes in the circuit itself, have still further perfected and simplified a "Super" which for years has had no superior.

The New Victoreen is simply marvelous. Here you have A. C. operation at its best. Tone quality such as you have never heard before—selectivity such as you never dreamed to be possible—simplicity of assembly developed to the point where anyone can construct a set which is as nearly perfect as human ingenuity has been able to devise.

The heart of this new Victoreen circuit is of course the world-famous Victoreen R. F. Transformer—greatly improved in efficiency, with binding posts located for maximum convenience in wiring. Each transformer is individually tuned to a precision of less than 1/3 of one per cent by the Victoreen patented method.

These new Transformers, together with the other Victoreen components which are used in this remarkable set, are literally years ahead of their time. To get the results which only Victoreen gives, either build, or have built for you, a Victoreen Super.

**BLUE PRINT FREE**  
together with full constructional details. Write for it today.

## Victoreen "B" Power Supply

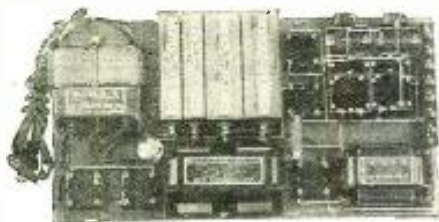

Supplies 45, 90, 180 and 450 volts, using a UX 210 or 250 in the last stage. Contains two voltage regulator tubes so that the 90 and 180 volt taps are supplied with a constant volt potential. It is the last word in "B" supply. For the most satisfactory results you must have it.

FREE BLUE PRINT, with list of parts and complete assembly instructions, will be sent upon request.

The George W. Walker Company  
Merchandisers of Victoreen Radio Parts  
2825 Chester Ave., Cleveland, Ohio

# Victoreen

Quality Radio Parts

Please say you saw it in RADIO NEWS

frequencies" seems most logical, but the "I. F." of the superheterodyne is already too well established. Perhaps we shall have "I. F." amplifiers for television frequencies.

It is too early to start on the task of standardizing the vocabulary; but we must have an eye to the future and see that the newcomer in radio is not saddled with names that will be a burden in days to come. We must have, O philosophers, a new "teleology."

Mr. H. Gernsback, editor of this publication, while addressing an audience at the New York University, at the occasion of

WRNY's television inauguration, perhaps had in mind all this and more, when he stated that he could not refrain from beating the newspaper columnists at their own game when he suggested that hereafter, we will call an inventor, not "visionary," but rather, "televisionary." Also, that we will not talk of a beautiful "vista" any longer, but it will, of course, surely be a "televista"; and, that certain females who are now called "perfect visions," are, of course, to become "perfect televisions"; and that finally, there will, of course, be a great many "televisecracks."

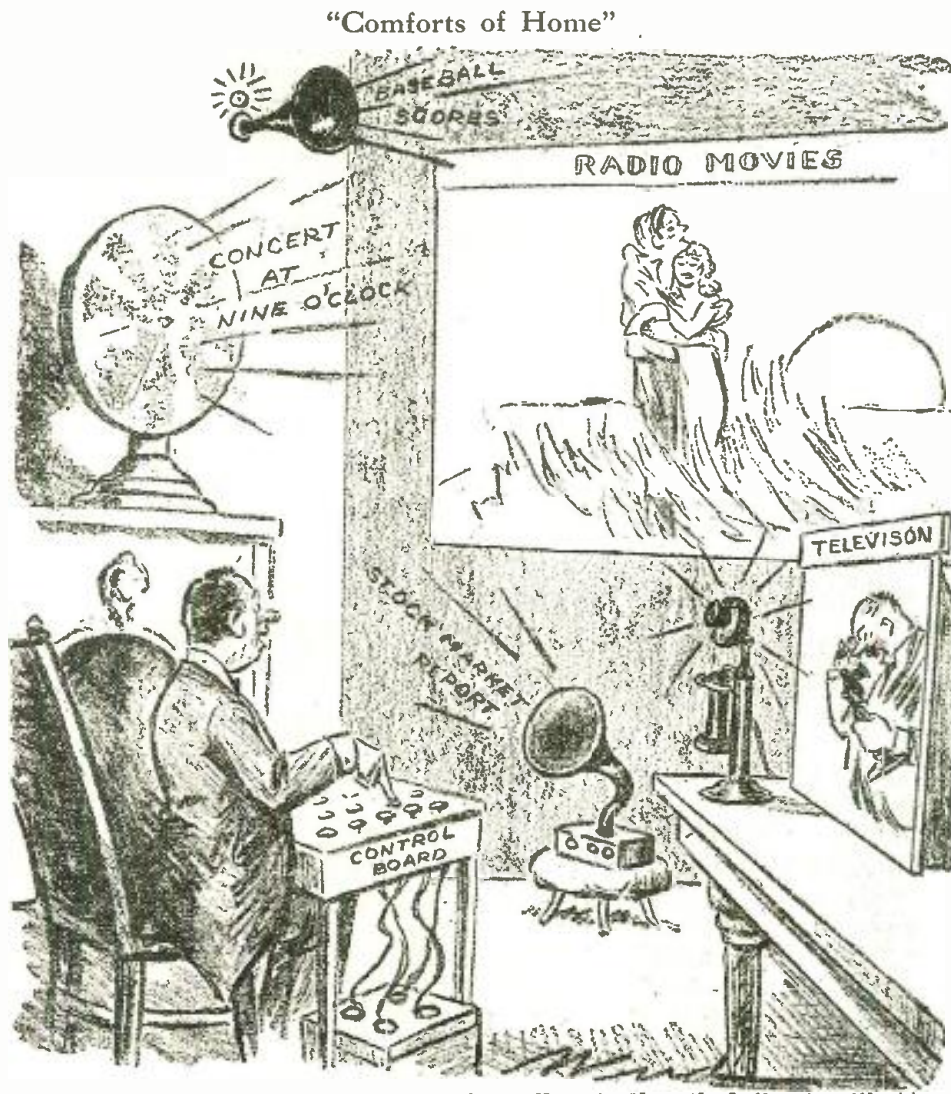

—Clive Weed in New York Evening World

Radio fans will see that the number of sound reproducers is somewhat too large; and the television will probably be of a later model. But the idea is clever, even though the "Television" is one-l'd.

## "C" Voltage Depends on "B" Voltage

WHEN "B" batteries are used to supply the plate current for a receiver, listeners are cautioned to watch the voltage of the batteries and to discard them when the voltage of each 45-volt block runs down to about 34 volts, or when that of each 22½-volt block runs down to about 17 volts.

Fans who employ "B" batteries therefore usually test them at regular intervals to determine whether the batteries are still good for further service.

A matter of vital importance which is often overlooked, however, is that of providing a proper relation between the grid-bias voltage and the plate voltage.

It is generally known that, while "B" bat-

teries run down with usage, the "C" battery will last for the entire life of the battery without any appreciable loss of voltage.

This means that when the "B" batteries are new, the proper grid bias is being used for best results; but just as soon as the "B" battery voltage begins to decrease, the grid-bias voltage is greater than is needed for the lowered plate voltage.

In such cases, if the grid-bias voltage is reduced in proportion, as determined by consulting the tables showing the proper plate voltage-grid-bias voltage characteristics of the tube, the amplifying efficiency of the tube can be maintained at a high level in spite of lowered plate voltage from the "B" batteries.

# Now - Make Your Radio Clear as a Bell - with Marvelous New GROUND AERIAL!



### Sub-Aerial Endorsed by Experts

May 8th, 1928  
 "I am very glad to state that after testing many Aerials in my Laboratory I find your Sub-Aerial is the best for clarity of tone and elimination of static, also for greater volume and selectivity.  
 Your Sub-Aerial will fill a long-felt want among the Radio Fans."

A. B. Johnson,  
 Radio Engineer

Chicago, May 9th, 1928  
 "Received my Sub-Aerial and it has been installed as per directions. We are more than satisfied with the results. The tone is marvellously clear without static interruptions. We would not consider changing back to an outdoor aerial under any circumstances."

M. H. Grey,  
 1416 Juneway Terrace.

### Get Amazing Distance—Greater Volume and Finer Selectivity Without Distortion

Why go on listening to terrible static and other maddening outside noises? Now you can get the real music your present Radio is capable of giving, by hooking your set on to the clear, practically static free ground waves with Sub-Aerial. The air is always full of static and your overhead aerial picks it up and brings it to your speaker. So why stay in the air—when you can use the whole earth as a static and noise filter with Sub-Aerial?

SUB-AERIAL is a scientific, proven system of taking the radio waves from the ground, where they are filtered practically free of static. It brings these filtered waves to your radio set clear of static and interference common with overhead aerials. The result is positively clear reception, remarkable selectivity and greatly increased volume. The overhead aerial is a thing of the past because it is the weak link in radio. SUB-AERIAL has replaced overhead aerials because SUB-AERIAL is 100% efficient. How can you get good reception without one?

### Low Original Cost—No Upkeep Cost

SUB-AERIAL costs no more than an overhead or loop aerial and less than many. Its first cost is the only one. SUB-AERIAL is permanent. No trouble—no hard work, or risking your neck on roofs.

### 25 Year Guarantee

SUB-AERIAL is guaranteed against any defects in workmanship or material and against deterioration for 25 years. Any SUB-AERIAL which has been installed according to directions and proves defective or deteriorates within 25 years, will be replaced free of charge; and also we will pay \$1.00 for installing any such new replacement.

## TRY IT FREE!

We know so well the surprising results you'll get that we'll let you put in a Sub-Aerial entirely at our Risk. You be the Judge. Don't take down your overhead Aerial. Pick a summer night when static and noise interference on your old Aerial are "Just Terrible." If Sub-Aerial doesn't Sell Itself to You Right Then on Performance—you needn't pay us a cent. Send for "all the Dope on Sub-Aerial." You'll be surprised. Do it NOW.

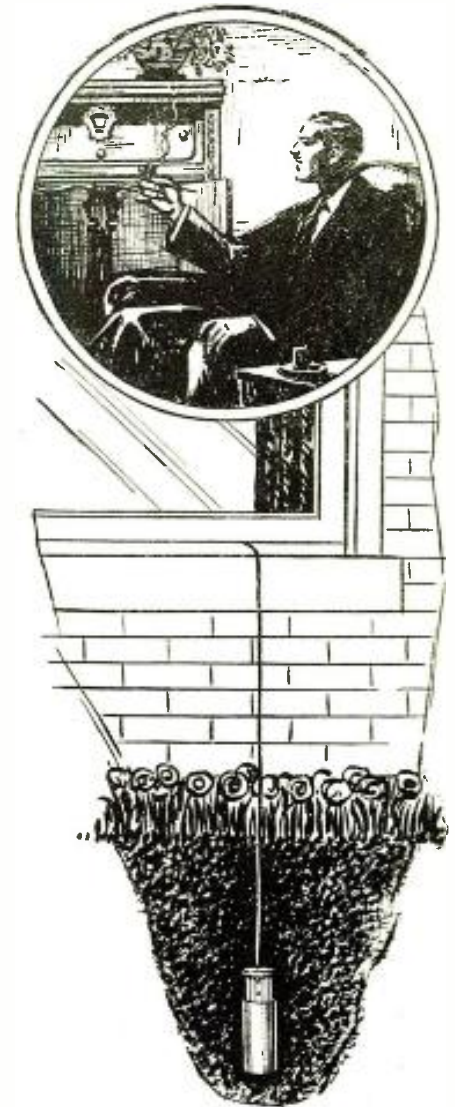

Can Be Installed in a Few Minutes

### UNDERGROUND AERIAL SYSTEMS

St. Clair Bldg., Dept. P  
 Corner St. Clair and Erie Sts., Chicago, Ill.

# Ground Out Static with SUB-AERIAL

Underground Aerial Systems, Dept. 9-P  
 St. Clair Bldg., cor. St. Clair and Erie Sts., Chicago, Ill.  
 Send me complete information on Sub-Aerial, Proof and Free Trial Offer. No obligation.

Name.....  
 Address.....  
 City.....  
 State.....

Please say you saw it in RADIO NEWS

**Follow the Lead**  
of the  
**LEADING**  
**MANUFACTURERS**

**PAY MORE**  
**GET MORE**  
with

**DUBILIER**  
**SOCKET POWER**  
**CONDENSERS**

After exhaustive tests, the engineers of the leading manufacturers, have standardized on Dubilier Condensers. They pay more for them—but they have the assurance that their sets are going to stay sold and they know that the ample factor of safety means long life. They can't afford to take a chance—and save a few cents. And neither can you!



Type PL-666 and PL-667 are standard equipment on high voltage AmerTran, Samson, Thordarson and other power packs specifying UX 281 or CX 381 type rectifier tubes. Type PL-666—2 mfd. 1000 volts—\$6.50; Type PL-667—4 mfd—1000 volts—Price \$11.00.

You can forget the Condensers—  
if they are Dubiliers.

**Dubilier**  
**LIGHT SOCKET AERIAL**

If it does  
not work  
on your  
set—your  
money back



And we mean it! If it doesn't give you smooth reception, reduce static and interference and give you plenty of volume the dealer will give you your money back within 5 days. Uses no current. Just attach to your set and plug in to a convenient light socket. Price \$1.50.

Write for free booklet

**Dubilier**  
**CONDENSER**  
**CORPORATION**

4377 BRONX BLVD. NEW YORK



**PERHAPS IT WAS TELEVISION YOU HEARD**

Program of radio entertainment from the *Providence Journal* of August 5: "9:35 p. m. Baseball scores. 's Luskv 4 oMaHwpluh. EAL m m m wkwk." What is the use of trying to eliminate static when they are actually broadcasting it this year! We surrender right now.—*Chester H. Page.*

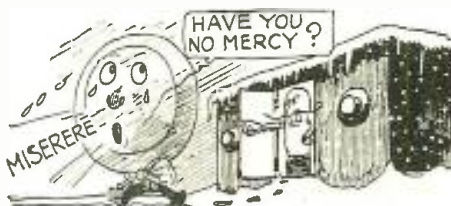

**THE ORPHAN OF THE STORM**

Directions enclosed with tubes by S. S. Kresge Co.: "It is essential that a grid battery be used, otherwise the windings of the loud speaker will probably be TURNED OUT." Oh, Mr. Tube, have pity on a poor old speaker, who has no other place to lay his diaphragm, and don't drive him out into the cold.—*Anonymous.*



**IF SINNERS ENTICE THEE,  
CONSENT THOU**

Perils to which radio parts are exposed—morally and otherwise—revealed by W. C. Braun's catalog: "The slightest inaccuracy allows disastrous TUNES to rush through to the tubes." We think the R.M.A. should establish a Big Brothers' league to keep young and innocent tubes from imitating the Monk of Siberia.—*Rowland Bohstedt.*

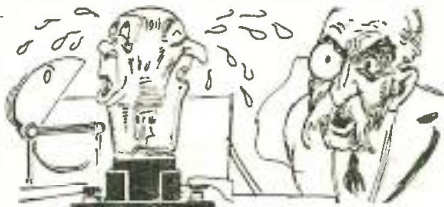

**DOCTOR, WHEREFORE THESE TEARS?**

Court procedure for compulsory licensing under Marconi patents of Loewe multiple-tube sets elicits the fact, as reported by the *London Star*, that some of these tubes contain "two LAMENTATIONS," making it possible to "get every European station to Moscow for a total price of £4 17s wholesale." Why the lamentation—unless it is for more continents to conquer?—*A. M. Gibbs (England).*

**OH, THOSE POWER-HOUSE CHORDS!**

Affirmative reply by the *New York Times* of July 1 to the query, "Can I put a DYNAMO speaker in series with an ordinary cone?" raises the question whether or not this combination, like Charity, will not begin to hum? As soon as we have a spare moment, however, we may try it out with our M. G.—*John C. Heberger, S.A.F.C.*

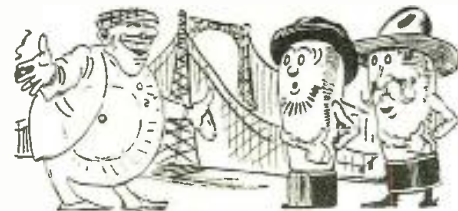

**ATTENTION, BETTER BUSINESS BUREAU**

Suspicious of the Blue Sky bureau were aroused by advertisement of "3-foot double Cox speaker kit," in *Hampton-Wright's* catalog. Mike, the fearless investigator, went out sleuthing, and detected this slippery speaker endeavoring to sell the Wheatstone Bridge to a couple of newly-arrived and innocent tubes.—*Raoul Escallier.*

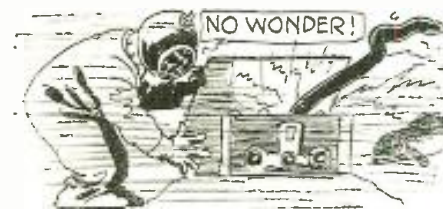

**BLAME THOSE ELECTRIC EELS!**

Advice to a set owner whose battery runs down too soon, from the *Sydney Sun* of July 3: "It is possible there may be a partial short-circuit in the SEA." We think that a socket-power unit will be cheaper than a diver's suit, in that case. What do you say?—*Sid H. Cox, (Australia).*



**GO TO THE ANT, THOU SLUGGARD**

Advice of Solomon put to practical use by new invention advertised in the *Boston Post* of June 15: "Johnson ANTOMATIC charger, \$5." We suppose that the power of the industrious ants charges the battery; but we would have to catch an awful lot of them. The charger could be taken with a portable set to the next picnic, though.—*Robert H. Leskovich.*

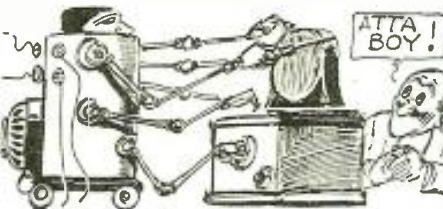

**REMODELED WHILE YOU WAIT**

Boon offered to the wearied experimenter by *Hamilton-Carr's* latest: "Sterling Power OUTFIT transformer...\$2.91." We have sent for this and will set it to work changing the old five-tuber into an A.C. screen-grid superhet with television attachment. While one is transforming the outfit, the job might as well be a thorough one.—*Ted E. Jocelyn.*



# WHOLESALE PRICES

for Dealers, Community Set Builders, General Repairmen and Agents!



Be sure to get this great 144-page book with net prices to the radio trade.

Radio Specialty Company is radio's oldest radio parts mail order house in the country, and the new confidential prices on standard radio merchandise are the lowest of any radio house.

We are ready now to appoint additional agents in all parts of the country. If you are contemplating making big money in radio merchandise, be sure to get in touch with us at once.

## Television is here!

Radio Specialty, as usual, is first with all new things. Send at once for free booklet for lowest prices on all television parts which have been put on the market so far. (If you have Catalog No. 18, just ask for the Television Supplement.)

New 75 HOOKUPS  
500 ILLUSTRATIONS

THIS 144 PAGE RADIO CATALOGUE FREE

## BUY from Radio's Oldest Mail Order House!

We are the oldest established, exclusive radio mail order house in the country. All orders are positively shipped within twenty-four hours; quick, prompt, courteous service. We carry a larger variety of radio parts, radio instruments, accessories and radio findings than any other radio house in the country.

You will find in Catalog No. 18 the largest assortment of radio merchandise in this country. Radio Specialty carries more radio parts and radio material than any other house in the country. You will find in this catalog positively the largest variety of radio merchandise.

If you are in need of certain small radio parts that other radio and mail order houses do not bother to carry get the Rasco Catalog and you will find the small parts there, anything from a screw to copper ribbon, telephone diaphragms, as well as thousands of other small radio findings. Just to mention a few:

Lugs, nuts, jacks, plugs, all kinds of knobs, cords, panels, screws, sliders, washers, selenium, tinfoil, switches, crystals, cap nuts, Litz wire, cord tips, brass rods, resistances, binding posts, switch parts, carbon balls, switch points, lock washers, carbon grains, ground clamps, metal pointers, insulated tubing, low melting metal, antenna connectors, as well as thousands of other articles. We carry the Largest Variety of Small Radio Parts in the World, BUT We also carry All Standard Radio Merchandise.

"RASCO" has it

ANYTHING IN RADIO

# Radio Specialty Co.

98W PARK PLACE, NEW YORK



Please say you saw it in RADIO NEWS

## Raytheon Kino-Lamp



## TWO PIONEER TELEVISION ACCESSORIES

The Raytheon Laboratories invite correspondence from both engineers and amateurs in regard to these two accessories now in successful operation.

Raytheon Kino-Lamp is the first television-reception tube developed to work on all systems.

Raytheon Foto-Cell, an extra sensitive broadcasting tube, is supplied in either hard vacuum or gas-filled types.

RAYTHEON MFG. CO.

Kendall Square Bldg., Cambridge, Mass.



## Raytheon Foto-Cell



### PARTS IN CONSERVATORY STYLE

Floricultural fashion note in *Sears, Roebuck & Co's* catalog for the coming season: "Heavy POTTED transformers." Radio fans who are interested in decorative effects will jump at this chance to decorate the music room with transformers, instead of the old style palms and rubber plants.—Rowland Bohstedt.

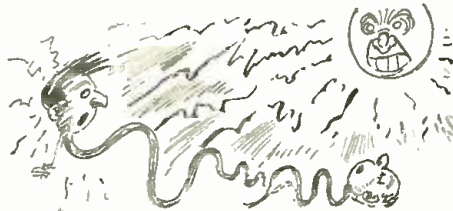

### A SUNBURNT SCIENTIST'S THEORY

Explanation of the "skip-distance" effect in the *Sydney Herald* of June 29: "The ionisation is caused by the ULTRA-VIOLENT light transmitted from the sun." Well, if we were a little bit of a wave, only a few meters long, we'd steer quite clear of the Heavyside layer, where such dangerous traveling conditions prevail.—Robert F. Wylie (Australia).

## Radio As an Advertising Force

DOES radio advertising pay? Some radio advertisers, like Mr. Henry Field, of Shenandoah, Iowa, have shown that the most direct kind of advertising does pay, if it is suited to its prospective customers. Other advertisers who have used more indirect methods have evidently found that their sales sheets showed very encouraging trends. But what of the business which looks upon radio as a direct competitor—the great industry which entertains the public in person, and must therefore regard as a disturbing influence whatever makes the fireside armchair more attractive at the close of the day?

Here is a most pertinent putting of the case by a third party in interest—a radio merchant to whom radio is but an incidental item, though a large one.

This advertisement was published by Bloomingdale's, a concern operating a large department store on the upper east side of New York City, as well as stores in Brooklyn, N. Y., and Newark, N. J., and takes the form of an open letter to a well-known figure in the great industry of selling ringside seats:

"Think it over, Mr. Rickard! After the Tunney-Heency fight the newspapers quoted you as saying, 'I blame much of the failure to have out a paying crowd on the radio. It helped kill my business.' Are you absolutely certain that your loss is due to radio broadcasting? As one of the leading radio stores in this country, we feel it to be our duty toward the millions of radio owners to point out a few interesting facts in the matter.

"Before broadcasting—the biggest attendance was 40,000, the biggest gate receipt \$450,000; after broadcasting—the biggest attendance was 165,000, the biggest gate re-

### THE MONDAY-MORNING SIX

Household convenience offered by *Gardener & White*, Detroit, Mich.: "Crystal Electric Washer, \$120. TUBES and SPEAKER priced extra." The Lux program is said to be extraordinarily effective on this instrument, which should indeed make washday a pleasure. But we hope that the static will not fray our collars or take the buttons off our shirts.—J. S. Bevan.

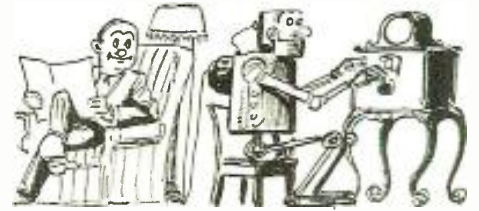

### RICHARD IS AN R.E.

The new short-wave receiver described in the *Boston Globe* of August 5 is evidently operated by a mechanical man: "Tuning with the metallic Dick is accomplished by angular displacement." We understood that Mike is the iron man who steers ships; but it seems that Richard is the radio expert of the family.—H. A. Ausin.

If you see any humorous misprints about Radio in the press, clip them out and send them to **RADIOTICS**, c/o RADIO NEWS; send also the heading of the page, showing name and date of publication of the paper or magazine. Add a few humorous words of comment; the best contributions will be printed, in case two or more send in the same **RADIOTIC**. For each one printed here, \$1.00 will be paid.

ceipt \$2,650,000; an increase in attendance of 312% and in receipts of 589%.

"These are the facts, Mr. Rickard! They tell an altogether different story. They show that fighting came into its own with radio broadcasting. That both gate receipts and attendance reached their highest point at the peak of radio broadcasting. . . . Radio has raised pugilism to the dignity of a great national sport with a new following of millions of men and women. Think it over, Mr. Rickard. It may be that you even owe a debt of gratitude to the thirty million men and women—the 'Ladies and Gentlemen of the Radio Audience.'"

The detailed figures which accompany the advertisement only further exemplify the argument; but to date, Mr. Rickard's comeback has not been recorded. At any rate, if radio advertising entertains the stay-at-homes, it certainly coaxes no small number out and into the throng of cash customers.

### IN STRICT CONFIDENCE

VISITOR: "And what became of the radio set you had?"

HOSTESS: "Oh, it didn't work right; so I got rid of it."

VISITOR: "I couldn't meet my payments either."—Edward Piranian.

### THE ULTIMATE ULTIMO

SMITH: "If prizes were given for the laziest man, Biggs would get the fur-lined bathtub."

JONES: "Is he so lazy?"

SMITH: "Is he? He's so lazy, he'd rather listen to a bedtime story than turn the dial"—Mollie Zacharias.

Please say you saw it in **RADIO NEWS**

# Chemistry paves the road to Success!

Some people measure success in terms of money and others in degree of knowledge and culture. Chemistry is the one uncrowded profession today that offers both. America, always a land of amazing opportunities, is especially so now in the field of applied Chemistry. Industries have developed within eight years more rapidly than the output of trained men to conduct them. Every big industry needs chemists and there is a real demand for them immediately.

## Earn a Bigger Salary from now on

### Good Chemists Command High Salaries

Not only are there boundless opportunities for amassing wealth in Chemistry, but the profession affords congenial employment at good salaries to hundreds of thousands who merely follow out its present applications. These applications are innumerable, touching intimately every business and every product in the world. The work of the chemist can hardly be called work at all. It is the keenest and most enjoyable kind of pleasure. The days in a chemical laboratory are filled with thrilling and delightful experimentation, with the alluring prospect of a discovery that may spell Fortune always at hand to spur your enthusiasm.

### You can make yourself independent for life by unearthing one of Chemistry's undiscovered Secrets

Do you remember how the tales of pirate gold used to fire your imagination and make you want to sail the uncharted seas in search of treasure and adventure? And then you would regret that such things were no longer done. But that is a mistake. They *are* done—today and every day—not on desert islands, but in the chemical laboratories throughout your own country. Quietly, systematically, the chemist works. His work is difficult, but more adventurous than the blood-curdling deeds of the Spanish Main. Instead of meeting an early and violent death on some forgotten shore, he gathers wealth and honor through his valuable contributions to humanity. Alfred Nobel, the Swedish chemist who invented dynamite, made so many millions that the income alone from his bequests provides five \$40,000 prizes every year for the advancement of science and peace. Herman Frasch, who showed how to extract sulphur, built up a huge fortune. C. M. Hall, the chemist who discovered how to manufacture aluminum, made millions through this discovery. F. G. Cottrell, who devised a valuable process for recovering the waste from flue gases, James Gayley, who showed how to save enormous losses in steel manufacture. L. H. Baekeland, who invented Bakelite—these are only a few of the men to whom fortunes have come through their chemical achievements.

#### YOU CAN LEARN AT HOME

To qualify for this remarkable calling requires specialized training. Formerly it was necessary to attend a university for several years to acquire that training, but thanks to our highly perfected and thorough system of instruction, you can now stay at home, keep your position, and let us educate you in Chemistry during your spare time. Even with only common schooling you can take our course and equip yourself for immediate practical work in a chemical laboratory.

#### EASY MONTHLY PAYMENTS

You don't have to have even the small price of the course to start. You can pay for it in small monthly amounts—so small that you won't feel them. The cost of the course is very low, and includes everything, even the chemistry outfit—there are no extras to buy with our course. Our plan of monthly payments places a chemical education within the reach of everyone.

#### MAIL THE COUPON FOR FREE BOOK

Your name and address on the coupon will bring you by return mail our interesting free book, "OPPORTUNITIES FOR CHEMISTS," and full particulars about the course and what it will do for you. You owe it to yourself to get this book. Send the coupon right now while it is fresh in your mind. Or just write your name and address on a postal and mail to us. But whatever you do, act today.

SEIZE THIS OPPORTUNITY—MAIL COUPON NOW!

## Chemical Institute of New York, Inc.

Home Extension Division 11

16-18-R-East 30th Street

New York, N. Y.

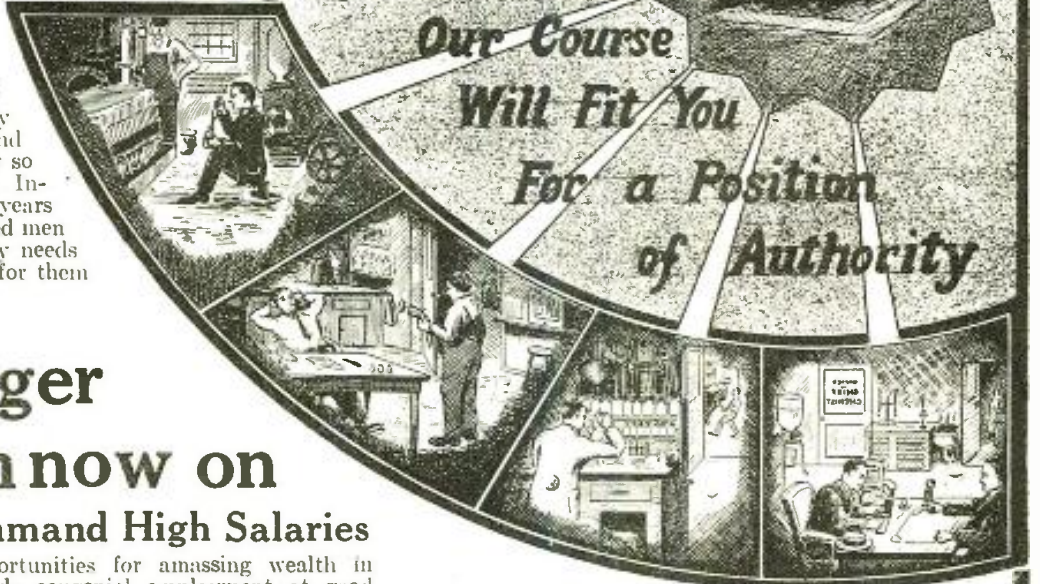

#### Just a Few Letters From Students Who Have Taken This Course

You will probably be pleased to learn one of the lessons gave me an idea to turn my chemical knowledge to profitable account. I am now making a varnish and paint which undersells the other type products by \$2.60 a gallon, in some cases more. Have been receiving gallon orders from painters during past week which has netted me a profit of \$12.50 for my "spare-time chemical industry." Many thanks for your training thus far.

J. J. KELLY

I am but half-way through your course and am certain that I have saved my Company many times the cost of the course and raised myself in the shareholders' estimation. The knowledge obtained has its immediate practical application and I do not hesitate in saying your course and the personal attention you give is invaluable to the practical man in any business where chemistry plays a part. You may use this letter and my name and address to the furtherance of your good work.

JOHN WALTER.

I have not written since I received the big set. I can still say that it far exceeded my anticipations. Since I have been studying with your school I have been appointed chemist for the Scranton Coal Co., testing all the coal and ash by proximate analysis. The lessons are helping me wonderfully, and the interesting way in which they are written makes me wait patiently for each lesson.

MORLAIS COUZENS.



T. O'CONOR SLOANE, A.B., A.M., LL.D., Ph.D.

Noted Instructor, Lecturer and Author. Formerly Treasurer American Chemical Society and a practical chemist with many well-known achievements to his credit. Not only has Dr. Sloane taught chemistry for years but he was for many years engaged in commercial chemistry work.

#### EXPERIMENTAL EQUIPMENT FURNISHED TO EVERY STUDENT

We give to every student, without additional charge, his chemical equipment, including fifty-two pieces of laboratory apparatus and supplies, and fifty-two different chemicals and reagents. These comprise the apparatus and chemicals used for the experimental work of the course. The fitted heavy wooden box serves not only as a case for the outfit, but also as a useful laboratory accessory for performing countless experiments.

#### CHEMICAL INSTITUTE OF NEW YORK, INC.

Home Extension Division 11  
16-18-R-East 30th Street, New York, N. Y.

Please send me at once, without any obligation on my part, your free book, "Opportunities for Chemists," and full particulars about the Experimental Equipment given to every student. Also please tell me about your plan of payment.

NAME.....

ADDRESS.....

CITY.....STATE.....

R-N-11-28

Please say you saw it in RADIO NEWS.

**LONGER LIFE**



**CECO**  
PRONOUNCED  
SEE - CO  
**Radio Tubes**

WHEN you install a set of CeCo Tubes in your radio, you immediately notice the greater clarity of reproduction—the increased sensitivity and the better volume.

But your greatest satisfaction will come with their longer operating life—making CeCo the most economical tubes to buy, and worthy of their slogan, “they cost no more, but last longer.” This is made possible partly by the exclusive method of evacuation.

To avoid disappointing results, make sure each socket is equipped with CeCo tubes. Whether for battery or A. C. operation, there’s a CeCo for every radio need—including “special purpose” tubes that are not obtainable elsewhere. They are sold by leading dealers everywhere.

*Tune in Monday evenings to the nearest of the 18 Columbia Broadcasting Stations and hear the musical program of the CeCo Couriers—8 P. M. Eastern Time, 7 P. M. Central Time.*

**CeCo MANUFACTURING Co., Inc.**  
PROVIDENCE, R. I.

## Radio “Bugs”

THE amazingly lifelike figures which our ingenious readers made out of the conventional figures of the schematic circuit are not without honor abroad. European magazines are following the example of Radio News; and from our contemporary, *Radiowelt* of Vienna (Austria) we take

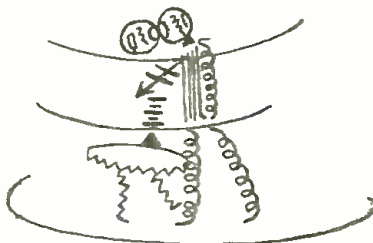

these two fine specimens, which show that humor, like radio, is international.

“Die Wellenwalzer”—the dance of the waves, is expressive; even though the lady’s skirt is unusual, it strongly evidences that one touch of jazz makes the whole world kin.

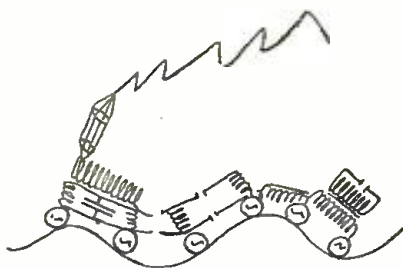

“Die Lokalbahn von Radiopolis” will be relished by all commuters on the Blank, Dash and !!! Railroad; we do not specify more closely, on account of the libel laws, but you will recognize this as the train which is met by the Toonerville Trolley.

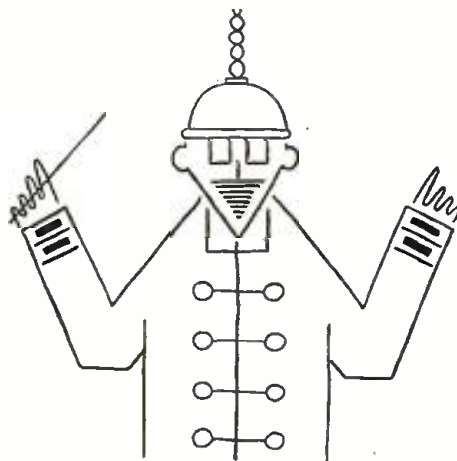

Our own “Bug” contest closed some months back, but we take the opportunity to give a couple of excellent sketches which have since reached us from Leo D. Keller, of Rochester, N. Y. “The Waveband Director” should be able to straighten out the radio concert; let us hope so.

The trolley car shown here should be

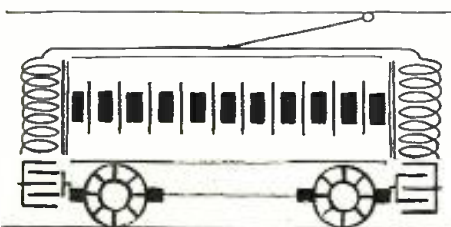

quite oscillatory. Let us be thankful that it does not pass too close to our humble residence and receiving station. Just one more example, and this department closes again with acknowledgements to all its conductors.

“Short Waves from Java on the Peridyne” is the humorous title which Henry Newhoff, of Chicago, applies to this ingenious sketch of a combined coffee pot and Peridyne stage. We don’t know just how

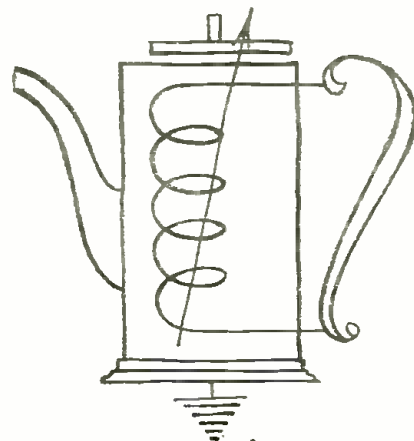

practical the idea is; but a milk (?) shaker makes a good shield, according to our Beginner’s editor, and we wait to see an entry of this kind in the Monthly Construction Feature.

If you have any more “Bugs,” consult the corner druggist, or the community trouble shooter. The department of Radio Entomology is now a has-been, and some of our friends may hint that it is a never-was.

### Advertising or Subsidies?

IN Australia, radio set owners pay licenses which are used to support “Class A” stations; while “Class B” stations, owned in most cases by organizations which desire a mouthpiece for their views, are not so favored. Since the Commonwealth’s postal authorities have undertaken a coordination of the programs and activities of the “Class A” stations, a request has been presented on behalf of the “B” stations for either a share of the license revenues or the exclusive right to accept paid advertising. In the latter case, the virtues of the sponsored programs might be fairly tried out—were it not that the Australian listener must pay the bills of the preferred stations, whether or not he prefers other programs. Our American system has still some advantages which will commend it to the listeners, even though there may be a few corresponding drawbacks.

### Brightness No Guide

SET operators, who have been used to consider the brilliancy of tubes as a measure of their operating condition, encounter a new condition with the new A.C. heated-cathode tubes, such as the 227-type. The manufacturers explain that differences in the light emitted have nothing to do with the performance of these tubes. Only a portion of the heating element or filament is exposed, and changes in its brilliancy at this point do not imply that the temperature below is incorrect. These tubes will stand a very considerable overload on the filaments; though, of course, the wise experimenter will not subject them to the test.

## Television Trials

(Continued from page 429)

best systems must be worked out by actual practice. Will transmission be easier, and reception clearer, on this waveband or that? Which mechanical system will be most satisfactory in the long run?

We may compare the state of television and its kindred arts to that of transportation in 1832: it is no time as yet for standardization. The "Tom Thumb" was a good locomotive in its day, but railroading would have been at a sad pass if it had to be standardized on the basis of such machinery. So with television: it has yet a few years ahead of it in which to be perfected, and undoubtedly the final apparatus which will be used for home, as well as commercial, scientific and governmental reception will be as much superior to that with which we are now working as the great passenger and freight locomotives of today exceed the "Tom Thumb" in efficiency.

### SPECIALIZED SYSTEMS FOR ALL NEEDS

It is probable that, even when television has become a perfected art, we shall be a long ways from standardization. The problem of the frequency bands which can be allotted for the purpose is one of the principal ones; even if broadcasting is revolutionized, it is probable that comparatively-limited bands will be used for the television transmissions which will be receivable in the home. Much more elaborate apparatus will be used to project pictures in theatres and other places where large groups of spectators are gathered. (Again, we need a new word in the language; perhaps a "televicence" will signify the gathering who are looking on the screen of the televisor.) Other purposes will demand elaborate apparatus, operating probably on wavebands which are today useless even for experiment, but which will yield a frequency range capable of carrying the most detailed images, of largest sizes.

For the present, the most advanced televisionaries are yet in the kindergarten class, and every conceivable system and arrangement must undergo careful test by engineers and other experimenters; the field is too wide for any one man or group of men, with even the most elaborate equipment that scientific organizations possess. The home experimenter will have to nibble at this dish and that, for the banquet of television dainties will present too many courses for one digestion.

However, Radio News does sympathize with those of its readers who are desirous of keeping fully abreast of all that is going on; and to the best of its ability, it will present ideas for the use of apparatus with which it will be possible to receive as many different systems as possible. Apparatus manufacturers, too, are keeping this contingency in mind; and, while different television systems permit of varying ranges of speed and detail of pictures, we shall undoubtedly have soon combination discs which may be used, by simple adjustment, for reception of coarser or finer images, at different locations of the glow-lamp and scanning hood. And, too, we may before long find the scanning-disc system entirely superseded by more refined electrical devices.

James Clerk Maxwell predicted the laws of radio in 1867.

# Be a Radio Expert

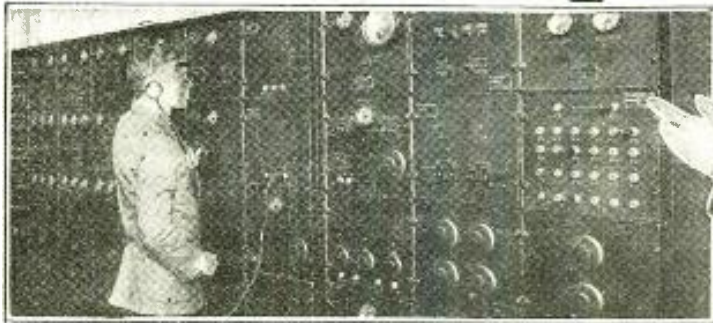

J. E. Smith  
President

**I've trained hundreds of fellows at home in their spare time for Big Pay Radio Jobs.**

## Look at These Earnings

**Has Made \$10,000 More In Radio**

"I can safely say that I have made \$10,000 more in Radio than I would have made if I had continued at the old job. When I enrolled with you I didn't know a volt from an ampere. I advise all ambitious young men to get into Radio. There is no greater opportunity."

Victor L. Osgood,  
981 Cranford Ave.  
Bronx, New York City.

**\$500 a Month**

"When I enrolled with N. R. I. I was a motorman on a trolley car. Now I have a fine, fast growing Radio business. I have \$2900 in the bank and about \$300 worth of Radio stock. I made it all since graduating less than six months ago."

Richard Butler,  
3535 Sheffield St.,  
Philadelphia, Pa.

**\$3,000 a Year**

"I cannot give too much credit to the N. R. I. for what I have been able to do in Radio. I have averaged \$3000 a year for the past three years. I am in the Radio business. I consider all the success I have obtained so far due entirely to your training."

Fred A. Nichols,  
Hercord, Colo.

**I give you a home experimental laboratory. You can design and build 100 circuits with it. Here are two ~**

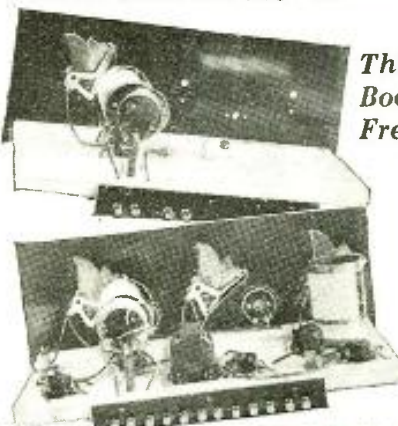

**This is Radio's Biggest Year**

**A great training made greater- Television now included**

Television can easily and quickly become as big as the whole Radio field is today. That's why you ought to know all about the different systems for sending and receiving pictures—there are many good jobs right ahead. Jenkin's, Cooley's, Bell's, Baird's, Bellini's, Alexanderson's methods are covered in our course. Your Radio training will be absolutely complete when you hook-up with N. R. I.

RADIO'S amazing growth is making hundreds of big-pay jobs every year. Trained men are needed. You young, ambitious men, starting out, who are looking around for something really good, and you older men, who aren't satisfied but want more money—here's a field that is growing fast enough to bring success in a year or two. I have doubled, tripled, quadrupled the salaries of men in one year. My book points out the many jobs in Radio. Clip the coupon. Get a copy now. Why be satisfied with anything less than \$50 to \$250 a week when that's what Radio pays its good men?

**So Many Opportunities—Many Begin Making \$10 to \$30 a Week Extra Almost at Once**

You don't have to wait one year, two years, not even six months to begin getting the extra money you want. I'll show you the plans and ideas that are making \$10, \$20 and \$30 a week extra for my students—show you how to begin doing it too the first month if you study hard and follow my plans. G. W. Page, 1807 21st Ave., S., Nashville, Tenn., made \$935 in his spare time while taking my course. Earle Cummings, 18 Webster St., Haverhill, Mass., writes: "I have made as high as \$375 in one month in my spare time." No need to worry about money, this is the famous course that pays for itself.

### Learn at Home

Don't lose a minute from your job. All I ask is part of your spare time. My practical method of training with six big outfits of Radio parts makes learning at home easy, fascinating, a pleasure. Boys 14, men up to 60 have finished my course successfully. You don't need a high school education. Many of my most successful graduates didn't even finish the grades.

### You Must Be Satisfied

The day you enroll I'll give you a contract agreeing to refund every penny of your money if you are not satisfied with the lessons and instruction I give you.

### Get This Book AT ONCE

"Rich Rewards in Radio" shows where the big jobs are, what they pay, what others are making. It has started hundreds of fellows on the road to bigger money who thought success was not for them. Get a copy. Not the slightest obligation. Do it Now.

J. E. SMITH  
President

Dept. 33SS  
National Radio Institute  
Washington, D.C.



**This Book Free!**

## Mail Coupon NOW

J. E. SMITH, President,  
Dept. 33SS, National Radio Institute,  
Washington, D. C.

Dear Mr. Smith: Send me your book, "Rich Rewards in Radio." I want to know about the money-making opportunities in Radio and your practical method of training men at home in their spare time to become Radio experts. This request does not obligate me.

Name .....  
Address .....  
City ..... State .....

Please say you saw it in RADIO NEWS



## "A" FILTER



A recent development, which converts any two or five-ampere charger into a 4 or 6 volt "A" Supply Unit in less than a minute's time.

The "A" Filter consists of a 8,000 mfd. capacity dry condenser with two specially designed chokes completely wired within one unit.

TOBE "A" FILTER \$18.00

Just attach your Charger

Write for Literature

Tobe Deutschmann Co.  
Canton, Mass.

## Synchronized Broadcast

(Continued from page 426)

and another switch opening and closing the television-lamp circuit.

To maintain the scanning disc of the receiver in synchronism with that of the transmitter—a requisite to the production of a recognizable image—delicate adjustment is necessary. This, as in other manual synchronizing systems, is accomplished by the simple expedient of varying the series resistor of the motor; this is a task quickly mastered by the experienced operator, but one which requires continual attention.

### PROBLEMS YET FACED

While this exhibition is in the widest sense "television," it is not true radio vision—bearing exactly the same relation to the latter that the "Wired Wireless" described in last month's RADIO NEWS has to the broadcasts picked up by the listener's aerial. The problems of operating such a television system over wires are very similar to those of broadcasting; except that in the latter case modulation and demodulation of a radio frequency are necessary to obtain distant transmission. And, at the present time, wide-frequency channels are acquiring a value comparable with that of the Kohnor, which is hardly rarer.

Whether the medium of transmission is ether or copper wires bears but little on the main problems, of creating the "vision-impulses" at the transmitting end with sufficient energy to impress them on a photo-electrical system distinctly, and of synchronizing the receiving mechanism until a clear image will remain in the field of sight. The problems of amplifying a "television-frequency" band, wider than the audio band, through many powerful stages, are also alike in either system; though broadcasting and wire-line transmission have also well-known specific problems of their own. In any event, we may look forward with confident expectation to a not far-distant day when we shall hear and see together from a single, if complex, assembly of receiving apparatus.

### "Ventilation" in the 227-Tube Obtained by Mesh

WHY the mesh-plate instead of a continuous sheet of metal in the UY-227 heated-cathode tube? Many users of this tube have wondered about the reason for this change in the design of the outer element.

During the development of this type of tube, the laboratory engineers found that emission of electrons occurred, not only from the cathode, but also from the cylindrical grid and plate unless they were relatively cool. This would be an undesirable condition in the operation of a device of this kind, as it would set up conflicting currents in a radio receiver.

To allow the plate to remain cool, and to eliminate undesirable electron emission, the use of a wire-mesh plate was adopted, thus allowing the escape of much of the heat generated by the heavy current through the filament; the wattage of the 227-type heater is 3½ times that of the 201A-type filament, and the generation of heat consequently proportional.

Hertz discovered radio waves in 1887, twenty years after Maxwell calculated that they must exist.

## The RADIO NEWS AMATEURS HANDBOOK



50¢  
THE COPY

### A Guide to Radio For Every Fan

No radio enthusiast should be without a copy of the Radio News Amateurs' Handbook, the most complete chronicle of radio advancements available. Every known development, each worthwhile circuit, various methods of amplification, electrifying battery sets, all theories and practices,—in fact, everything noteworthy that has occurred since the beginning of radio is fully treated. Hundreds of the most popular radio receiving circuits of all times—circuits ranging from the early type of crystal sets to the latest and most elaborate multi-tube receivers of the present day. And with each circuit there is a complete set of constructional details explaining in full the principle on which the operation of each receiver is based together with step-by-step instructions for building.

Every "fan" should have a copy of this book. Its contents constitute a complete education in radio. The handiest of reference guides. A real encyclopedia. Fill in the coupon now. Do not wait. Get your copy of this most valuable of radio books, THE RADIO NEWS AMATEURS' HANDBOOK.

116 pages—Fully Illustrated  
Large 9 x 12

THE 50¢ COPY  
WRITE DIRECT

Experimenter Publishing Co., Inc.  
230 Fifth Avenue, New York, N. Y.

EXPERIMENTER PUBLISHING CO., INC.,  
230 Fifth Avenue, New York, N. Y.  
Gentlemen: Enclosed find 50c., for which send me a copy of RADIO NEWS AMATEURS' HANDBOOK.

Name.....  
Address.....  
City.....State.....

## BARAWIK THE OLD RELIABLE RADIO SERVICE

Radio Fans, from "way back when," will remember the exceptional service that Barawik rendered when getting radio parts was like pulling bear's teeth. First upon the scene, Barawik was always ready to deliver the newest developments in radio to its customers in the days when changes were fast and furious.

Today Barawik has grown to be a mighty institution in the radio world. Here you can secure the proved, reliable merchandise of the world's leading radio manufacturers—everything from complete sets to the smallest individual parts so necessary to the set builder. You can depend upon the reliability of Barawik goods. You can depend upon Barawik's ability to deliver the kind of service that means time saved in waiting. You can depend upon Barawik's honesty, ability and willingness to serve you—And, last, but far from least, you know that Barawik's big discounts assure you of the lowest prices always—prices that mean huge savings to you in everything you buy.

The newest in radio sets, parts, kits, supplies—all under one roof—ready for you now. Send coupon now for big new Catalog—Free.

### BARAWIK CO.

111 C Canal Sta.,  
CHICAGO,  
U. S. A.

Mail this Coupon Now for Barawik's Big Free Bargain Book.  
Name..... Address..... City.....

## \$1 SAVES YOUR SPEAKER

The CRAFTSMAN Dollar Speaker is guaranteed to relieve speaker of plate D. C. (180 to 250 volts). Complete Protection. One Dollar Postpaid.



CRAFTSMAN RADIO PRODUCTS  
9 Orchard St., Newark, N.J.

Insure your copy reaching you each month. Subscribe to RADIO NEWS—\$2.50 a year. Experimenter Publishing Co., 230 Fifth Ave., N. Y. C.

Please say you saw it in RADIO NEWS

# RADIO DIRECTORY



**RADIO-LITE-TENNA**

Write for details

**AERIAL INS. CO.**  
GREEN BAY, WIS.

**AMERICAN**



**Sub-Panel Brackets**  
Sub-panel brackets in various sizes ranging from 1" to 2 1/2" in height and from 7" to 11" in length. Cut Illustrates No. 11. Write for literature.

**American Radio Hardware Co.**  
Dept. 108, 135 Grand St.  
New York, N. Y.

**MAJESTIC CONE**



Natural Tone  
Designed for use with or without power tubes

List Price \$12.50  
**YOUR PRICE \$2.25**  
Postpaid

**AMPLIFLEX LOOPS**  
Collapsible. Folding—Built-in Compass. List price, \$32.50; our price, \$2.79. Postpaid. Write for Special Bargain now.

**SPIEGEL RADIO COMPANY**  
135 Liberty St., New York City



**BIRNBACH**

Moisture-Proof Extension Cords

Birnback Extension Cords permit the Loud Speaker to be moved to any room in the house. Attaches instantly. Install a Birnback Cord and put an end to distortion so often due to badly insulated cords. Your neighborhood dealer has these sizes in stock: 10-20-30-40-50-100 foot lengths. Send for Catalog.

**BIRNBACH RADIO CO.**  
254 W. 31st St., New York

If you want more hours of service per tube, insist upon

**PERRYMAN**

**RADIO TUBES**

"The tubes with the patented shock-proof bridge."

A tube for every radio purpose. All the A.C. types. Write for literature.

**Perryman Electric Co., Inc.**  
33 West 60th Street  
New York City



**USE YOUR RADIO MORE!**  
Thousands of homes get more use of their radio because of the exceptional economy and dependability of our "B" and "AB" equipment. WRITE!

**KIMLEY ELECTRIC CO.**  
441 East Ferry St.  
Buffalo, N. Y.

**BAKELITE PANELS**  
MAHOAGANY or BLACK

1 x 18.....	1/8	3.16
1 x 21.....	1/8	1.50
1 x 21.....	1/8	1.75
1 x 21.....	1/8	2.00
1 x 26.....	1/8	2.15

All Odd Sizes Cut to Order, 1/2¢ per Sq. In.  
Mail Orders Filled Same Day  
Send Money Order. Plus 15¢ for Postage

**CENTURY RADIO PANEL CORP.**  
Now located at  
67P Cortlandt St., New York  
Telephone Recker 7468



**B-L RECTIFIERS**  
Bone-dry  
Noiseless, Durable  
Compact

B-L Rectifiers embody a new principle. They are adaptable to all types of electrical equipment requiring low voltage rectifiers. Write for further information.

**THE BENWOOD-LINZE CO.**  
1832 Washington Avenue  
St. Louis, Mo.

**LINCOLN REVOLUTIONARY**  
A. F. Transformers



Designed by Kendall C. Cough. Give 50% more undistorted amplification. Heavy bass frequency register. Marvelous tone quality. Specified in famous Lincoln 8-80 receiver. Write for information on Lincoln No. 105 first, and Lincoln No. 106 second Audio Transformers.

**LINCOLN RADIO CORP.**  
329 S. Wood St., Chicago, Ill.

**SEND NOW**  
for  
New 1929  
**WESTERN RADIO'S CATALOG**

LATEST and FINEST, nationally known A.C. sets, consoles, cabinets, speakers and accessories at LOWEST PRICES. Catalog sent FREE on request.

**WESTERN RADIO MFG. CO.**  
128 W. Lake St.  
Dept. RNC11 Chicago

**O'NEIL Dynamics**



*The Speaker Hit of the Season*

Two types—one for A.C. operation, the other for D.C. Equipped with our dynamic units. Beautiful two-tone walnut finish to match the popular sets. Write for literature.

**O'NEIL MFG. CORP.**  
West New York, New Jersey



**Silver-Marshall 660-171A UNIPAC**

Supplies complete "A-B-C" Power. Contains built-in push-pull amplification stage requiring two 171A type power tubes.

List Price **YOUR COST \$29.50**  
In Kit Form—Your Cost \$26.50  
ALL NEW SEALED CARTONS.  
**RAUNER RADIO CO.**  
142 Liberty St., New York City

**THE B. B. L. MOTOR**



An improved motor for loud speaker operation. Power without saturation. Eddy currents reduced to minimum. Permanent adjustment assures the highest quality tone reproduction. Write for details.

**BEST MANUFACTURING CO.**  
1200 Grove St., Irvington, N. J.

**Television Tubes**



This marvelous new Raytheon Kinn-Lamp, which radio engineers call the greatest development in television, is now in stock. Be the first in your locality to build a television receiver. Send money order NOW.

**\$12.50**  
Newark Elec. Co.  
226 W. Madison St.  
Chicago, Ill.



The human ear could not detect further tone improvement than is given by

**Samson Symphonic Transformers**

Send for full information  
**SAMSON ELECTRIC CO.**  
Canton, Mass.



**BAKELITE and HARD RUBBER**

DRILLING — ENGRAVING  
PUNCHING — STAMPING  
Latest Circuit Panels in Stock

We cater to retail as well as manufacturing trade.

**Cortlandt Panel Engraving Co.**  
165 Greenwich St., N. Y. C.

**SPEAKER TABLE**



Beautiful Colonial design. Solid walnut, hand rubbed. Size, 30" x 12" and 31" high. Made with Temble Air - Chrome speaker or for dynamic speaker. This is only one of many beautiful Friggs creations for this year. Write for full particulars and see catalog.

**D. H. FRITTS & CO.**  
604 Hearst Bldg., Chicago

**200,000**

RADIO NEWS readers carefully scan the RADIO DIRECTORY every month.

**YOUR product here at the lowest cost in the world's largest and most widely read radio magazine.**

**RATE CARD**

Per Issue	\$25.00
Three time rate	23.75
Six time rate	22.50

No order for less than three insertions accepted. Write for information.

**Radio News, 230 5th Ave.**



**BODINE ELECTRIC TURNTABLE**

For radio-photograph combinations—no brushes, no commutator, no sparking. Positively no interference in the loud-speaker. Write today for full information on this big new development.

**BODINE ELECTRIC CO.**  
2242 West Ohio St., Chicago, Ill.



Dealers, write for catalog  
**W. C. BRAUN CO.**  
552 Monroe St., Chicago



**NOPHONONIC TUBE CAPS**

Stop That Howl!

To get the best from your set, be sure that all tubes employ

**Nophononic Tube Caps. Stops all vibration of the filament.**  
List Price, ..... 25¢  
Ask your dealer or write direct  
**MERTZ SPECIALTY CO.**  
1306 Stockton Street  
Wilmington, Del.

**Pacent PHONOVOX**

**THE ELECTRIC PICK-UP**

**Pacent Electric Co.**  
Inc.  
91 7th Ave. New York

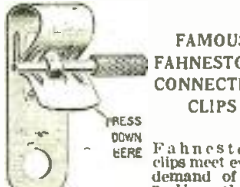

**FAMOUS FAHNESTOCK CONNECTION CLIPS**

Press Down Here

Fahnestock clips meet every demand of the radio public. Use them for appearance, positive contact, and durability. Write for catalog or pick them out at your nearest dealers.

**FAHNESTOCK ELECTRIC CO.**  
Long Island City, New York

**SEND FOR NEW RADIO BOOK**

All the new hook-ups. Parts, supplies, A.C. sets, television, short wave, etc.

Write for free copy now.

**The Barawick Co.**  
211 B Canal Sta., Chicago



**Carborundum**

Fixed Crystal Detector  
Fixed Crystal Detector  
Bell-clear, Noiseless, Sensitive  
Will bring improved tones to practically any set. Can be adjusted to suit your set. From dealer or direct—\$1.50

**THE CARBORUNDUM CO.**  
Write for Hook-up Book D-1.  
Niagara Falls, N. Y.



**DE JUR VITREOUS ENAMELED POWER RESISTANCES**

For "B" eliminators, power amplifiers and electric sets. These resistances are backed by 16 years of continuous, satisfactory service to the radio public. Write for catalog.

**DE JUR PRODUCTS CO.**  
199 Lafayette St., New York, N. Y.

**SAVE YOURSELF MONEY**

**SEND FOR OUR MONEY SAVING CATALOG Now**

**SET BUILDERS DEALERS!**

Save money, time and bother by purchasing kits and parts from us. Maximum discounts to dealers. Latest kits and parts always in stock. Send NOW for catalog.

**Wholesale Radio Service Co.**  
6R Church St.  
New York

**NAME PLATES**

**WE SPECIALIZE IN NAME PLATES OF ALL VARIETIES: ETCHED PLATES, EMBOSSED PLATES, RADIO ESCUTCHEON PLATES**

Write for Samples and Prices.

**ETCHED PRODUCTS CORP.**  
Queens Boulevard,  
LONG ISLAND CITY - N.Y.



**CORWICO BRAIDITE Hook-Up Wire**

"The Braid Slides Back"  
Make your connection, solder it and the insulation slides right back into place. If your dealer can't supply you, order direct

25 Ft. Solid, 30¢  
25 Ft. Stranded, 35¢  
**CORNISH WIRE CO.**  
32 Church St., New York

**Send for This**

We have a new illustrated catalog showing our up-to-the-minute stock of kits, parts and sets—everything you want in radio—all at dealers' wholesale prices. Write today for Catalog "B-1."

**ALLIED RADIO CORPORATION**  
711 W. Lake St.  
Dept. "B-1," Chicago, Ill.

The RADIO DIRECTORY is your buying guide. Space permits display of only one product at a time. Write advertisers for complete catalogue.

THESE

2



MAGAZINES

for

THE PRICE

OF

1

A year's subscription to these two popular magazines for the price of Radio News—alone. If you were to buy Radio News and Radio Listeners' Guide and Call Book individually for one year they would cost you \$5.00. By our special combination yearly subscription rate you can get both of these foremost radio periodicals at the tremendous bargain price of \$3.00. In order to keep up with the latest developments of Radio, to know the newest sets and how to build them, to find every radio broadcasting station you must read these leading periodicals of radio.

The RADIO LISTENERS' GUIDE AND CALL BOOK is the foremost quarterly magazine in the field. A special feature of this remarkable magazine is the up-to-the-minute log of every station in this country,

Special Combination Yearly Subscription Rate

**\$3.00**

For the Radio Listeners' Guide and Call Book and Radio News

**EXPERIMENTER PUBLISHING COMPANY**

230 5th AVE., NEW YORK CITY, N. Y.

Canada and in Europe. This list of call letters is carefully checked and corrected in each quarterly edition.

RADIO NEWS is read each month by more radio enthusiasts than any other publication in the field. It contains the latest developments and the most modern circuits of the radio world. Honest, unbiased opinions on every subject of interest—this is what RADIO NEWS gives you.

Write today—insure your receiving each issue of RADIO LISTENERS' GUIDE and CALL BOOK and RADIO NEWS. Take advantage of this special subscription offer—Two magazines for the price of one.

EXPERIMENTER PUBLISHING COMPANY  
 230 5th AVE., NEW YORK, N. Y.  
 Gentlemen:—Enclosed find \$3.00 for which please send me the RADIO LISTENERS' GUIDE and CALL BOOK, and RADIO NEWS for one year beginning with the next issue. It is understood there will be no further payments of any kind.  
 Name .....  
 Address .....  
 City .....  
 State.....



## "Rays of Justice"

(Continued from page 433)

Unanimously the engineers diagnosed the trouble as being caused by too-small insulators. Feverishly they set about to design a new insulator of huge proportions which no current under a million and a half volts could possibly break down. This, the engineers felt, would by its sheer size alone render failure impossible. Yet all the time they were haunted by the uncanny way in which the two insulators had broken down—at identically the same point, at the same time, in the same way. The laws of probability utterly forbade such coincidences.

The interest in the proceedings was so widespread that the public-spirited Harold Dare, at the suggestion of his thoughtful public-relations department, arranged for the broadcasting of the installation of the new insulator. As if going on location, a whole company of technicians from the Dare studios set out from Hollywood, transporting with them all the equipment necessary for connection with the regular television channels. The power truck with its gasoline-driven generator outfit was placed behind a ledge of rock several hundred feet away, lest its deafening noise spoil the audio part of the broadcast. At noon they came on the air through WROP, and throughout the afternoon continued to report the progress of the work to a thrilled citizenry touched anew by the thoughtfulness of Harold Dare, thrilled with the opportunity of witnessing this dramatic engineering crisis.

It was not until dusk that the linemen were finally whipping the heavy cables into place, and huge daylight arcs were already flooding the ridge with light. The television pick-up device was sent aloft in a captive balloon to the level of the tower top. A spotlight played upon the linemen who were putting the finishing touches to the last splice. The tension tightened as the crucial moment approached when the Wolf Creek line would be put under test.

Then Fate took a hand. Perhaps the strain was too much for the long span of cable which carried current from the generator to the half-dozen flaming floodlights. A wire sagged, broke; an arc crackled, and darkness plunged down over the ridge, while the thundering power machine raced wildly without a load.

But the screen of the television was not dark. A million people gazed horror-stricken; for to the topmost cross-arm of the huge tower clung two living skeletons—skeletons whose hands clutched pliers, skeletons that shouted hoarsely for lights!

It was but a moment until electricians had repaired the broken wire, and the lights flared forth again; but from their room in the Hollywood laboratories, Dare and his engineers had seen all. The great screen star reached for his telephone; a few words to the operator and his transmitter was switched into the microphone circuits of WROP. A moment later his voice was reassuring thousands of shocked and shaken radio listeners that all was well, that the strange mystery which perplexed the world's best engineering talent was on the point of solution, and that if they would have patience, all would be explained.

Then mysterious telephone calls began to fly about Hollywood, and in answer, cars

**SCAN THE  
ETHER  
WITH  
The New  
"222"**

**SHIELD  
GRID**

★

Combining the proven, hyper-sensitive STROBODDYNE system with the tremendous amplification obtained through the use of the new shield grid tubes, in a special circuit making full use of their extra high amplification factor.

**The "222" STROBODDYNE  
Latest Design by  
R. E. LACAULT, E.E.**

leaves far behind all other types of sets. Its performance has amazed experienced engineers and it has come through hard tests with flying colors.

**SPECIFICATIONS**

- 1—QUALITY OF REPRODUCTION**  
Through the use of high grade audio transformers combined with a push-pull amplifier and the best method of detection, the most remarkable fidelity is obtained. The results will amaze the most critical musicians.
- 2—VOLUME**  
The tremendous amplification of the shield grid tubes produce unusual volume which may, however, be regulated to any desired value through a special control.
- 3—SELECTIVITY**  
The very high impedance of the shield grid tube, combined with the special circuit used, makes the tuning very sharp without affecting the quality.
- 4—SENSITIVENESS**  
The sensitiveness of this receiver is so much greater than that of any existing set that it is beyond comparison. There is **NO LIMIT** to the range. The noise level is the only factor affecting it.
- 5—SHIELDING**  
Entire R.F. system completely shielded.
- 6—EASE OF CONTROL**  
Only two dials, a volume control and sensitiveness control are used—making the set easy to operate.
- 7—STROBODDYNE SYSTEM**  
The STROBODDYNE method of reception—a time-tested and proven circuit—is incorporated in the set, causing very weak signals to produce a tremendous response.
- 8—MATERIAL**  
Only the very best of tested parts are used in the entire set, insuring permanent high efficiency.
- 9—DESIGN**  
The new "222" STROBODDYNE is designed by R. E. Lacault, E.E., well known creator of several famous circuits, whose reputation is a guarantee of the high grade radio engineering incorporated in this set.

Read how to build it in the September issue of Radio News and Blue Print No. 63

We are equipped to give you

**PROMPT MAIL ORDER SERVICE**

All genuine parts carried in stock

**ORDER DIRECT from**

**R. E. LACAULT, INC.**

116 West 65th Street, Dept. 405, New York City

Cable Address  
**LACRAD NEW YORK**

Long Distance Phone  
**SUSQUEHANNA 2095**



Please say you saw it in RADIO NEWS

# AERO KITS



## INTERNATIONAL Short-Wave Converter

Will Add Thousands of Miles To Your Receiving Range

Broadest reception on short waves is remarkably clear and free from static. Programs are brought in from greater distances with the utmost simplicity of control. You can easily build the Aero International Short-Wave Converter and receive short-wave programs on your present set. No changes in wiring necessary. Just plug into detector socket.

AERO KIT No. 9.....\$38.90

### THE "STANDARD"

No extra tube is needed for this Aero Short-Wave Converter. Plug into detector socket of your receiver and insert the tube which you removed from set into the Converter. Kit is complete with all parts. Can be assembled in a few minutes. For A.C. or D.C. receivers.



Price—\$32.00

Write for information about the New 1929 Aero Green Book

**AERO PRODUCTS**  
INCORPORATED  
Dept. 188, 4611 E. Ravenswood Ave., Chicago, Ill.

# \$75 to \$125 Weekly

## Charging Batteries Starts You

Let me show you how to make big money right from the start. I've prepared a FREE book explaining all details. First week's profit pays for all equipment. You can get all the battery charging business in your community with my Service Station Charger—it's years ahead of ordinary chargers—handles 50% to 70% more batteries. I explain everything—start you in a business of your own and put you on the way to big money. Write for FREE BOOK.

C. F. HOLMES, Chief Engineer, Dept. R.N  
Independent Electric Works  
5116 Ravenswood Ave. Chicago, Ill.

**FREE BOOK—Just Out**



## FREE Wholesale Radio Catalog

Set Builders-Dealers! Save Money! Send for the most complete book of nationally known Parts, Kits, Cabinets, Consoles, Speakers, Power Units, Sets, etc. All at lowest wholesale prices. Quick service on all your needs. Write now, it is FREE—  
**SETBUILDERS SUPPLY CO.**  
Dept. 13-3 Romberg Bldg. Madison and Market Sts. CHICAGO, ILL.

## BIGGER Radio Guide

Keep pace with radio's newest ideas—J.C. and tube, dynamic television, scores of new developments. Since radio's dawn Barawik has kept ahead by bigger stocks, better service, lowest prices. Barawik's Big New Radio Guide is now ready—send for it.  
Wholesale discounts to set builders, dealers and agents.  
**FREE** BARAWIK CO., 211D Canal St., Chicago U.S.A.

came speeding from all directions to the sacred inner court of the Dare studios. At the Dare private flying field, a score of men suddenly appeared; the doors of the hangars were opened, and two speedy pursuit planes roared forth and vanished into the night. And at Wolf Creek, a crew of linemen, acting upon mysterious orders that had come by telephone from certain high offices, worked for an amazingly long time at a simple task that should have required not more than twenty minutes.

An hour and a half had passed when three cars with lights dimmed low sped up the bare pretense of a road that led up to the scene of the engineering catastrophe, to discharge a grim group of men. At a word from their leader they separated into two groups and set off in opposite directions. Then Harold Dare himself stepped out before the battery of floodlights and spoke into the microphone standing on a pedestal.

"Friends," he said, in a low, earnest voice that found instant response in the heart of every listener, "there is one who has plotted for years to work my ruin—a veritable fiend in human form, whom all the world knows and hates. As principal stockholder in a certain power corporation, he has done his utmost to hurt me by endangering the confidence of the public in me and my new power project. Dandy Diavolo and his minions are responsible for the three successive breakdowns in the Wolf Creek line. What proof? See for yourself. Watch the three insulators which suspend the cables of the Wolf Creek line."

The crew of linemen scurried down from their tower. One by one the floodlights dimmed. In the televisor was seen the group of huge strings of insulators hanging from the cross-arms.

"Now, operators at Wolf Creek are starting the turbines, sending half a million volts surging along those cables."

A faint glow appeared about the ends of the insulators. Momentarily it grew. A tongue of light darted out from the cable, then spat across to the corona shield and vanished. A flickering halo encircled the tips of the insulators, gradually spreading into a luminous cone. Then suddenly a band of flame ripped across the gap. With a report as of a cannon, two huge insulators plunged downward. Two heavy cables swung sinuously out against the tower; two bursts of flame, a shower of drops of molten copper, and the line was dead.

"Lights!" cried Dare. From the truck which had been backed to the edge of the cliff, two huge searchlights suddenly shot long shafts of light downward into the depths of the valley below; and where the two accusing fingers pointed, the world saw a group of swarthy, evil-faced men gathered about a truck almost entirely screened from view by the surrounding shrubbery. Even as they leaped to their feet, a dozen stalwart men stepped out of the darkness on all sides, guns in hand, and the henchmen looked into a circle of menacing muzzles. With one accord they raised their hands heavenward.

The operator of the televisor adjusted his instrument for a close-up. Upon television screens everywhere, a group of strange instruments and glass tubes of peculiar shapes were seen to cover the truck; and in the foreground glared the cruel, evil features of Dandy Diavolo. He shook his fist toward the brilliant beam

# WHITEHEAD EXPLAINS THE GAME OF BRIDGE

World's Greatest Authority Reveals Secrets of Success

Wilbur C. Whitehead, in his master instruction book, "BRIDGE," passes on to the beginner the secrets of the game that made him famous. "BRIDGE by Whitehead" is a new and absolutely unique instruction method for the game of Bridge. It employs what Whitehead is pleased to term the "picture method" for instruction. Every play in the game of Bridge is fully illustrated. There is page after page of illustrations, showing every conceivable hand, also adequate text matter to fully explain each play. Everyone can learn to play this popular game by this easy method.

How efficient are you at the play? Do you know what to bid and when to bid it? Can you explain the following accurately: the auction; the book and odd tricks; rank of bids; the pass; the double; the redouble; the contract; who is the declarer, the adversaries, the dummy? Can you keep score? What are honors, slams, the rubber? These are but a few of the many component parts of the game of Bridge. Whitehead's new method will make this fascinating game easy for you.

*Read "BRIDGE by Whitehead." No one is so good a player that he will not benefit by this valuable book—no one so poor a player that he cannot become expert by following this wonderful instruction course.*

Over 100 pages. Each play illustrated Large 9" x 12" size

THE **50c** COPY

AT ALL NEWSSTANDS OR WRITE DIRECT TO THE

**EXPERIMENTER PUBLISHING CO., Inc.**  
230 FIFTH AVE., NEW YORK, N. Y.

EXPERIMENTER PUBLISHING COMPANY, Inc.  
230 Fifth Ave., New York, N. Y.

Gentlemen: Enclosed find 50c. for which please send me a copy of "BRIDGE by Whitehead."

Name.....  
Address.....  
City.....State.....

Please say you saw it in RADIO NEWS

of light which sought him out; his features twisted into a typical Diavolo sneer, and as clearly as if in a sub-title, the watching world read the words the thin lips shaped: "Foiled again! Cur-r-rse you, Harold Dare!"

"The basis of my latest plot," said Dandy Diavolo in a public statement an hour later, as he was being swiftly transported in a cabin plane to Los Angeles, where the agents of justice awaited him, "was discovered by Hertz half a century ago, when he discovered that ultra-violet light facilitated the passage of a spark across a gap. It was later found that this was due to ionization of the air, and that the effect was intensified if waves of still higher frequency were used. In order to put the Wolf Creek line out of commission, I set up a bank of powerful X-ray tubes in the valley below a tower on the Wolf Creek line. The beams of X-rays thus projected upon the insulators ionized the air so that the high voltage easily jumped across over the insulators, which were already under severe electrical stress, as indicated by the corona. No matter how large an insulator had been placed on this tower, the current would still have broken it down. Only the long arm of coincidence saved Harold Dare, as always, from the working of my plot."

"What have you to say as to the way in which the plot was foiled, Mr. Dare?" asked a reporter.

"To set at rest the fears of my public regarding the skeletons which were seen upon the tower, let me first assure them that they saw merely ordinary X-ray pictures of the linemen at work, exactly as if taken by a doctor's X-ray. The photoelectric cell used in the television responded to the X-rays from Diavolo's tubes, which, traveling on through the linemen, threw shadows upon the television field. When the lights were on, these shadows were too faint to be seen; but when the power was accidentally disconnected, they came into prominence. Let me merely remind my public that this episode reiterates the great truth taught by every Dare super-special: namely, that in the end, right will inevitably triumph over wrong, and evil-doing will receive its just punishment. The long arm of coincidence is merely the agent of justice, which, acting also through the hand of Fate, always finally catches the wrong-doer in the clutch of circumstance. This time Dandy Diavolo has gone a step too far. Retribution has overtaken him, and during the next score or more of years when he will sit in the stone cells of the penitentiary, he will have abundant time to meditate upon the truth of this statement."

**A BIG CONSTRUCTION JOB**  
VAUDEVILLE FAN: "Which do you prefer, the Keith or Loew circuit?"

RETIRED HAM: "I can't really say; I haven't built a set for some time."

**HE HAD A GRIEVANCE**  
"My name is William Ransom Nathan Young!" roared the angry caller at the broadcast station.

"What if it is?" asked the polite attendant.

"What if it is!" thundered the caller. "Why, this station, without getting my permission, or even asking me, is using my initials!"—Guy T. Evans.

(We advised him to have it changed to Kasper De Koven Amberson.)

# The New Knapp "A" Power Kit



This is the "A" power after you have assembled it. A professional job! Operates on 105 to 120 volts, 50 to 60 cycles AC. Supplies rippleless DC current for operating any set using Standard 5 or 6 volt tubes and power tubes.

## Greater Efficiency—

## Improved Design and Appearance—Lower Price—Money-making Plan for Set-Builders

You radio fans who made my "A" power the largest selling "A" power last spring have made it possible for me to offer the finest "A" Power ever developed—in Kit form—even more complete than before. Study the illustrations—read the improvements—and you will wonder how I was able to reduce the price. You are the answer. I sold 5 times as many "A" Powers as I expected to—and this season I am counting on you to help me again by buying even more.

### The 8 Improvements

1. Larger Filter System—3 Elkon Condensers instead of 2. Ideal for Super Hets and Short Wave Sets.
2. Improved Choke Coils
3. Pendant Switch Controlling "A", "B" Eliminator & Set
4. Dial for regulating voltage
5. Celeron Front Panel
6. Baked finish
7. Heavier gauge metal cover
8. Die Cast Base Plate instead of wood

### COMPLETE KIT—EASILY ASSEMBLED

Like my Kit last year, the New Knapp Kit is a tooled job—the parts seem to fall into place. Every hole is drilled—all that it is necessary for you to do is to put the screws and nuts in place and connect a few wires. Everything is supplied. Nothing for you to buy extra. The fool-proof instruction sheet makes it easy for anyone to assemble.

### THE SET-BUILDER TAKEN CARE OF

You set-builders played with me (as the saying goes) and I am going to continue to play with you. My engineers have designed an "A" Power which is well-nigh perfect—my production men, based on tremendously large quantities have cut their cost, so that I can keep faith with you by reducing the cost. And regardless of what the established trade may think about it—I am going to continue to give you the maximum discounts. The coupon will bring you the full details of both the new "A" Power and the special discounts to set-builders. David W. Knapp, Pres.



KNAPP ELECTRIC, Inc., Port Chester, N. Y.  
—Div. P. R. Mallory & Co., Inc.—

Mr. David W. Knapp, President,  
KNAPP ELECTRIC, Inc.,  
400 Fox Island Road, Port Chester, N. Y.  
Kindly send me complete information on the  
Knapp "A" Power and your special discounts for  
Set-Builders.  
Name .....  
Address.....  
.....

**Shanco** *Battery Clip*  
GRIP-TITE POWERFUL TENSION

for an uninterrupted flow of Electrical Current



**Better Contact**

**Powerful Tension**

SHANCO Grip-Tite Battery Clips assure better contact. Hundreds of thousands have been sold and are giving complete satisfaction today. Here's the reason. The design is right and assures free and uninterrupted flow of electrical current. There are no springs to heat up or burn or drop out.

Shanco Grip-Tite Battery Clips are acid-resisting and are made of special powerful tensioned tempered spring steel, solidly riveted together. All parts are electro-plated before assembly (not galvanized nor tinned). The jaws open wide and are easily applied. Grip-Tite Bulldog Teeth "stay put" and bite right through corroded bars and terminals. The teeth are so arranged that the clip cannot fall over and short the battery. Here is a compact, solidly built battery clip that is a big value and a permanent investment. There are four sizes for every battery need. Five ampere, fifteen ampere, fifty ampere and three hundred ampere.

Mail the coupon at once for our special low prices and complete information.

SHANKLIN MFG. CO., Dept. 72, Springfield, Ill.

Gentlemen: Please send me complete information on your special Radio Battery Clips. No obligation, of course.

Name.....  
Address.....  
City.....State.....

**DABLE "B" BATTERY POWER**



100 Volt Edison Element. Non-pollutive, Rechargeable "B" Battery with charger. Shipped dry, with solution, \$12. 140 Volt with charger, \$17. 180 Volt Power Unit, with Trickle Charger, \$24.00. SEND NO MONEY—PAY EXPRESSMAN Write for our Free Literature SEE JAY BATTERY CO., 915 Brook Ave., New York

**AEROVOX** Makers of high quality resistors and condensers that are Built Better — to endure. Write for The Research Worker. A free monthly publication. AEROVOX WIRELESS CORPORATION 68 Washington Street, Brooklyn, N. Y.

**Sensitizing the R. F. Amplifier**

(Continued from page 453)

duces distortion. However, the potentiometer may be removed, the grid return changed from the movable arm of potentiometer to minus filament, and a variable resistor (of 200-500,000 ohms range) inserted in the plate circuit. An increase in selectivity will be noted, while the plate current drain will be materially reduced.

**REMODELING THE NEUTRODYNE**

The neutrodyne circuit may be rendered more sensitive by removing the neutralizing condensers and controlling the R.F. stages with a suitable variable resistor, placed in the plate circuit. Radio enthusiasts, anxious to secure real distance with neutralized sets, have sometimes replaced the fixed neutralizing condensers with tiny variable condensers, together with a suitable indication to show the normal adjustment for each condenser. A simpler method is to employ variable plate voltage, as mentioned; for then a single control takes care of the entire R.F. amplifier.

Lately the grid-suppressor method has come into wide favor. This comprises a 200- to 1800-ohm fixed resistor, depending on the circuit conditions and the tube, placed in the grid lead of each R.F. amplifier tube. The grid-suppression effect of a given resistor becomes more marked at higher frequencies, or lower wavelengths, which is a most desirable feature, since the tendency of most R.F. amplifiers to oscillate increases with frequency.

**WHEN TIME WAS MONEY**

LARRY: "They say it cost \$1.15 a second to broadcast the Democratic National Convention."

SANNY: "Gee! what a spendthrift that announcer was, with his 'Stand by one moment, please!'" — *Wm. G. Mortimer.*

**HOME, JAMES**

There was an announcer named James, A favorite indeed with the dames: But they all had to smile Every once in awhile When they heard him pronounce foreign names.

—*Mrs. Fred W. Auvache.*

**TO ERR IS HUMAN**



—*The Wireless Constructor, London.*

**AMERTRAN PF-250**  
**Power Transformer**  
for  
**UX 250 Power Tubes**

A husky transformer built for doing the job, not for looks. The PF-250 is rated at 1200-600 volts plate, 7½ volts power tube, 7½ volts rectifier tube filament. Center taps are provided on each of the filament windings. Continuous rated capacity of plate windings, 160 MA., continuous rated capacity of each 7½ volt winding, 3 Amperes. DC plate output with two UX 281's full wave, up to 450 volts with sufficient excess for "C" Bias.

Ask for Bulletin No. 1033 describing fully the PF-250.

Price, each—\$30.00  
*Slightly higher West of Rocky Mountains*

**American Transformer Co.**  
Transformer Builders for more than 25 Years  
263 Emmet St., Newark, N. J.

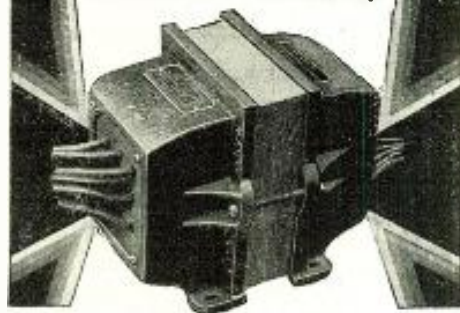

**DYNATONE DYNAMIC AND MAGNETIC REPRODUCERS**

Write for information on the new Dynatone 40-cycle reproducer. Brings out bass and depth from any set. Full dynamic movement.

Dynatone Electromagnetic Units...\$12.50  
Complete with 7-in. Cone and Baffle. 18.50

Sold under 10-day money-back guarantee. Send check or money-order in advance or pay postman.

**ALSO**

Complete set of blueprints and instructions for building your own DYNAMIC moving coil unit, with cone and baffle. New design makes home construction simple with few tools. Guaranteed to work. Sent postpaid anywhere upon receipt of \$1.00.

**FANSPEAKER RADIO COMPANY**  
74 DEY STREET - - NEW YORK, N. Y.

**Wholesale Prices**

Everything in radio—kits, parts, accessories, sets. Improved designs and styles. Big selection at worthwhile saving. Immediate service; personal attention. Send for complete, illustrated Catalog "B-1."

**Allied Radio Corporation**  
711 W. LAKE STREET, CHICAGO

## The "Pre-Selector"

(Continued from page 449)

into the receiver, it may be necessary to use a "B" battery for the Pre-Selector plate supply. In that case two of the small 22½-volt blocks ordinarily used as "C" batteries will serve the purpose and their life will be about a year, due to the extremely small plate current drain.

The proper connections for the batteries are shown in Figs. 2 and 3. In these diagrams both the Pre-Selector and receiver are shown connected to ground. In most cases it will only be necessary to ground one. The best plan is to try grounding each individually, and then both together, to determine the best arrangement.

### OPERATING THE PRE-SELECTOR

After the Pre-Selector has been connected and ready for operation, the necessary preliminary adjustments of the receiver proper should be made. First, adjust the receiver dials for a wavelength somewhere above the broadcast waveband; if the exact settings of the dials of a multi-control receiver are not known, adjust the dials as closely as possible. Then turn the receiver's volume control to the position for maximum volume. Also, turn on its filament switch; unless the receiver's filaments are to be turned on and off at the Pre-Selector, when the receiver's switch should be left turned on at all times.

Next, turn on the filaments of the Pre-Selector and adjust the rheostat to provide them a voltage between 3 and 3.3. Turn the Pre-Selector's "Volume Control" all the way to the right and adjust the "Sensitivity" control so that the plates of the midjet condenser C4 are all out (minimum regeneration).

With the left or "antenna selector" (wavelength) dial of the Pre-Selector at, say 40, slowly rotate the right-hand or "frequency selector" control knob until a station is heard. If none is heard, repeat the operation but with the wavelength control set at 50. It is important that the "frequency selector" control be turned slowly in hunting for stations; because the tuning with this control is so sharp that stations may be skipped over easily.

Once the first station has been heard, carefully readjust the two tuning controls of the Pre-Selector for maximum volume; then turn the "volume" knob back to reduce the volume to normal. The tuning controls of the receiver should now be readjusted to exact resonance, which is indicated by maximum volume. Also, any other adjustments provided in the receiver should be made now for maximum reception. If there are two or more antenna terminals, for instance, the Pre-Selector's output lead should be connected to the one which provides maximum energy transfer. It may be worth while to try also increasing the plate voltage on the R.F. tubes in an effort to increase the R.F. amplification. This will usually be found entirely practicable, because of the greater stability of most receivers when permanently tuned to a high wavelength.

Turning back to the Pre-Selector, it will be found advisable to experiment a little with the switch, SW2, and the regeneration control, in order to become familiar with their action and effect. Finally, adjust the small condenser C3 to bring the readings of the two tuning dials into line.

# New Admiralty Model

## NORDEN - HAUCK

### SHIELDED SUPER-10

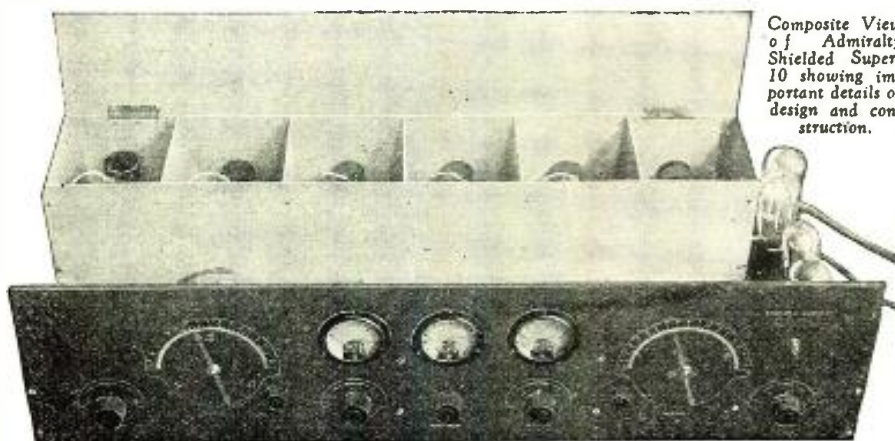

Composite View of Admiralty Shielded Super-10 showing important details of design and construction.

This great new Receiver is far in advance of competition. It is a powerful 10-tube model incorporating the most complete and up-to-date principles. Using the new screen grid tubes in the R. F. amplifier and push-pull audio system, make this new model the outstanding development in Receiver design for years.

### Features

10 tubes used. Five 222 screen grid R. F. amplifiers, 200A detector, two 210 Hi-Mu's and two 210 tubes in the power audio amplifier.  
Extremely sensitive—long range.  
Totally shielded.  
Super-selective—10 Kc. separation.  
Perfect quality of reproduction.

Indicating Meters on Panel.  
Removable R. F. Transformers for all wave lengths up to 25,000 meters.  
Electric or Battery operated.  
Simple to operate—only two major tuning controls.  
A laboratory precision Instrument built according to U. S. Navy Standards.

Complete attractive illustrated literature sent upon request. Full size genuine Blue Prints and constructional data \$2.00 Postpaid.

Write, telegraph or cable today.

## NORDEN-HAUCK, Inc., Engineers

Marine Bldg., Philadelphia, Pa.

Builders of the highest class radio apparatus in the world.

Cable—Norhauck

## FRESHMAN

YOUR ULTIMATE RADIO

AT ALL  
AUTHORIZED  
DEALERS

**Pathfinder** TRIAL  
EVERY WEEK 13 WEEKS  
\$1 A YEAR 15 CENTS

Your neighbors know the Pathfinder and you will like it—the every-week news digest from the Nation's Center. Bright, interesting, dependable, different—nothing else like it. Washington gossip, politics, science travel, fun, lots of pictures, instruction, entertainment. Trial 13 weeks—13 big issues—only 15 Cents—or \$1 for full year. Send now. Address: Pathfinder, Dept. 17, Washington, D. C.

## RADIO SCHOOL

SEND FOR CATALOG

MASSACHUSETTS RADIO and  
TELEGRAPH SCHOOL

18 Boylston St. Boston, Mass.

## More Profits To Set Builders

One good radio idea may be worth millions. Barawik has thousands of ideas for radio set builders to make more money. Barawik's Big Radio Book will help you while elections are on and big national events stir the world.

Send for your copy today - NOW.  
**BARAWIK CO.** 211 Canal Station,  
CHICAGO, U. S. A.



Please say you saw it in RADIO NEWS

# FANS! third big edition -

Don't  
Miss  
This  
Big  
Issue  
!

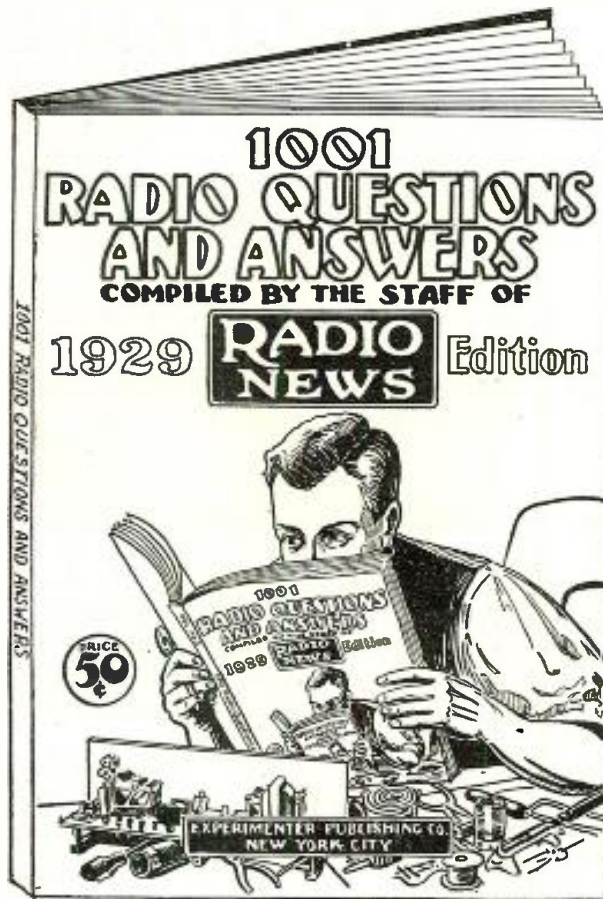

Over  
150,000  
Copies  
Already  
Sold  
!

Compiled by the Staff of RADIO NEWS

## Completely Revised-Up-to-the-Minute

1001 RADIO QUESTIONS AND ANSWERS, the most sensational seller in the radio field, is now in its third new and revised edition. No one interested in radio should be without a copy. The staff of RADIO NEWS, the leading fan magazine, has striven to make 1001 RADIO QUESTIONS AND ANSWERS the foremost work of its kind available. There is a full and complete explanation of every worthwhile circuit that has appeared since the beginning of radio, not only the explanation, but also complete diagrams from which the set can be con-

structed. Concise, authentic answers to every question that can possibly be asked concerning the many and varied branches of radio reception on both short-wave and broadcast bands.

**FANS! Don't hesitate! Get your copy today! Over 112 pages — fully illustrated—large magazine size**

**50c**

THE COPY

ASK YOUR NEWSDEALER  
OR WRITE DIRECT

**EXPERIMENTER PUBLISHING COMPANY, INC.**  
230 Fifth Avenue, New York, N. Y.

**Mail This Coupon NOW!**  
EXPERIMENTER PUBLISHING CO., INC.  
230 Fifth Avenue, New York, N. Y.

Gentlemen: Enclosed is 50c. Please forward  
me a copy of "1001 RADIO QUESTIONS  
AND ANSWERS."  
Name .....  
Address .....  
City .....  
State .....

Please say you saw it in RADIO NEWS

**COUPLING ADJUSTMENT**

A final word regarding the adjustment of the automatic coupling arrangement may be required. The cam should be slipped over the rear of the condenser shaft, with the fiber cam toward the rear and with the flat side uppermost. Now, with the condenser plates all meshed, turn the cam until its toe is just level with the bottom side of the bakelite strip upon which the coil is mounted; then tighten the set-screw in the collar on the cam. Next, loosen the set-screw in the brass pin on the lower rod of the coil carriage; let this pin slip along until it rests against the fiber cam, and then tighten the set-screw. With these adjustments made, it will be found that the primary coil moves as the condenser is rotated and, when the condenser plates are entirely unmeshed, the pin should slide just to the point of the cam. This is the correct adjustment.

In the event that there should be no reception when the Pre-Selector is first put into operation, and all connections and wiring are found to be correct, test the tube used in the oscillator socket, V2. The whole action of the Pre-Selector depends on the oscillator, and a poor or defective tube here will prevent proper reception.

**APPARATUS REQUIRED**

- The following is a complete list:  
 One variable condenser, .00035-mf. (C1);  
 One variable condenser, .00025-mf. (C2);  
 One equalizer condenser, 2-20-mm.f. (C3);  
 One midget condenser, 50-mm.f. (C4);  
 One fixed condenser, .00025-mf., with grid-leak clips (C5);  
 One fixed condenser, .0001-mf. (C6);  
 One by-pass condenser, 0.5-mf. (C7);  
 One antenna coupler, with provision for automatic coupling variation (L1);  
 One R.F. transformer (L2);  
 One R.F. choke coil, 85-millihenry (L3);  
 One rheostat-switch, 50-ohm (R1-SW1);  
 One volume-control potentiometer, 25,000-ohm (R2);  
 One grid leak, 2-megohm (R3);  
 One aerial switch, single-pole double-throw (SW2);  
 Two vacuum tubes, 199-type (V1 and V2);  
 Eight binding posts, push-type;  
 Two vernier dials, illuminated-type;  
 One front panel, 7 x 14 x 3/16-inch;  
 One binding-post strip, 1 x 10 x 3/16-inch;  
 One wooden baseboard, 13 1/4 x 7 x 1/2-inch;  
 Two angle brackets, 1 x 1/2-inch;  
 Two tube sockets, UX-type.

**Station**  
**WRNY**  
 NEW YORK  
 326 METERS — 920 KILOCYCLES  
 and W2XAL, 30.91 METERS  
*is owned and operated by the  
 publishers of this magazine  
 Our Editors will talk to you  
 several times every week—  
 See your Newspaper  
 for details*  
**TUNE IN ON  
 WRNY**

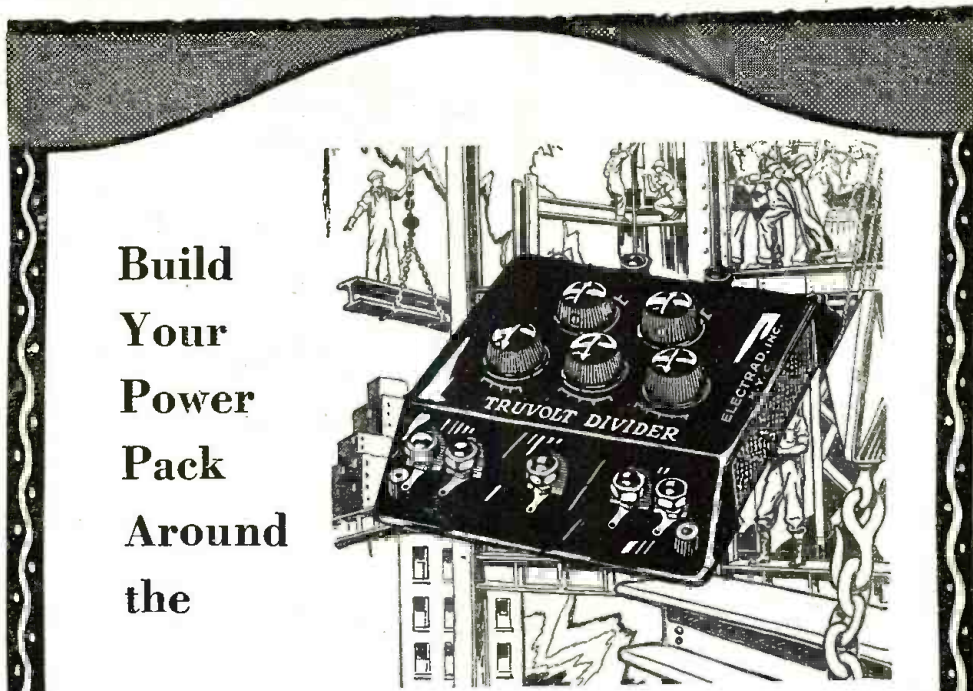

**Build  
 Your  
 Power  
 Pack  
 Around  
 the**

**TRUVOLT DIVIDER**

U. S. Pat. 1,676,869 and Pats. Pending

**A Universal Voltage Separator**

**T**his new Truvolt Divider offers you the complete resistance combination for constructing with utmost ease a remarkably efficient power pack suitable for operating any type of receiver up to 12 tubes.

By dividing the filtered voltage into usable values, it eliminates all necessity of mathematical calculations in constructing a power pack. It does away with a great deal of wiring and the need of voltage regulator tubes. It makes it possible to build a power supply device which is universal in its application.

Case made of genuine bakelite, it will add a smart appearance to any unit. Five potentiometer type control knobs show values on a scale of high visibility. Can be mounted on base-

board or sub-panel, or used as the front panel on a metal cabinet, at the same time providing binding posts for all "B" and "C" voltages.

**Price—\$12.50**

*Electrad Specializes in a Full Line of Controls for all Radio Purposes including Television.*

**ELECTRAD, INC.**  
 Dept. NA-11  
 175 Varick St., New York, N. Y.

Please send me FREE my copy of the Electrad Truvolt Divider Manual and put me on your mailing list for Circuit Data and information.

Name.....  
 Address.....  
 City..... State.....

*Write for Free Circulars and Full Information:*

**ELECTRAD** Inc.

**FLECHTHEIM**  
**SUPERIOR CONDENSERS**

Best for power packs, power amplifiers, and for the countless uses to which high-grade condensers are put. Conservatively rated, dependable in operation, and very reasonably priced, Flechtheim condensers have won for themselves an enviable reputation—a fact readily attested to by custom set builders, radio amateurs and experimenters everywhere. Complete Line from 250 to 3,000 Volts D. C.

*Write for New Catalog*  
**A. M. FLECHTHEIM & CO., INC.**  
 136 LIBERTY ST., NEW YORK, N. Y. Dept. NR.

**SET BUILDERS**  
*Get this Book*

**LATEST RADIO GUIDE**  
**FREE**

Barwik, the first and oldest radio specialty house, offers you unusual service this year. Bigger stocks, quicker shipments, lower prices. Deal with an old established, reliable house. Get honest goods, honest service, honest prices. Barwik service makes you more money. Send now for big new Catalog showing lowest wholesale prices.

**BARWIK CO.** 111H Canal Sta., CHICAGO, U. S. A.  
*Mail This Coupon Now for Free Radio Guide*

Name.....  
 Address.....

*Please say you saw it in RADIO NEWS*

### Facts About Transformers

(Continued from page 444)

do not exist in the original signal, and naturally distortion will result.

It can be seen that there are two opposing values which must be accounted for in designing a distortionless transformer. The first danger is having too low a primary impedance, and the second having too high a secondary capacity. There are several ways of reducing the impedance of the secondary winding so that a sufficiently large primary can be used. One of these methods is to use heavy insulation on the wire, and to space the layers of wire. This reduces the capacity of the winding.

The lowest frequency to which a person's ears will respond is about twenty per second. The highest frequencies used in the average radio musical performance are about five thousand, although the harmonics and overtones reach frequencies higher than ten thousand per second. Broadcast stations are limited, by law, to a maximum of five thousand cycles anyway. In order to give perfect reproduction, a transformer would have to respond to all of these frequencies. If only the second harmonic of the notes is reproduced, the tone will seem quite natural, since the higher harmonics do not appear to contribute very much to the naturalness of tone.

#### CONSTRUCTION

In the construction of transformers, the secondary winding is usually on the outside and the primary winding is placed next to the core of the secondary. The cores in practically all the iron-core transformers are made up of a number of thin sheets of transformer iron or steel. In an audio-frequency transformer, these laminations are usually very thin, and care is taken to insulate them from each other.

The push-pull transformer is very much like the straight step-up type, except that the secondary is twice the size of the ordinary type and has a tap in the center, connected to the "C—" battery, which "biases" the grids of the push-pull power tubes. Similarly, the "B+" power lead is connected to a similar center-tap on the primary of the push-pull output transformer, or of the output impedance.

The auto-transformer contains one long tapped winding, so that part of the winding comprises the primary while the complete coil is used as the secondary. The circuits of the three general types of transformers are shown in Fig. 6.

The output transformer is used to prevent the direct current applied to the plate of the last tube from injuring the loud-speaker winding. It also has another important use in balancing the output resistance of the tube with the impedance of the loud speaker. In order to get the most undistorted output from a power tube and loud-speaker combination, the loud speaker should have the same impedance as the plate circuit of the tube. The use of the transformer with the correct primary and secondary impedances will satisfactorily match these circuits when the tube and speaker do not match directly.

It is necessary to use a transformer with a large core so that current in the plate circuit of the tube will not be sufficient to overload the iron magnetically, as explained

# REMLER



## New Tone FOR OLD RADIOS

—with this Power Amplifier and "B" Supply

Camera-like fidelity of reproduction—lowest notes clear and rich—music such as you thought your radio could never deliver!

Three improvements—a new transformer principle, better use of the big power tubes, and stable plate and grid voltage supply—enable this unit to vastly better the tone quality of your present radio.

Available in semi-completed form . . . requires but an hour or so to put into operation . . . full, clear instructions . . . works from lighting circuit . . . coupon brings complete details.



### REMLER Twin-Rotor CONDENSER

For knife-edge tuning, use this famous twin-rotor condenser. Specified in circuits that demand extraordinary accuracy and efficiency. Price \$5.00.

### REMLER Drum DIAL

Rigid, heavy construction, smooth, no backlash, illuminated. Drum fifteen inches in circumference. Removable calibration strips. Price \$4.50



Use the coupon below for full information on Remler Parts and Units.

Remler Division, Gray & Danielson Mfg. Co., 260 First Street, San Francisco, California.

Gentlemen: Please send me:  
 . . . All the "dope" on the Power Amplifier.  
 . . . Bulletin service for professional set builders.

Name.....

Address.....

City.....State.....

Do you build and sell sets?.....RN-11

# Electricity

Learn in Los Angeles. Thoroughly practical course prepares young men, 18 and over, for technical and executive positions. Unlimited opportunities in California for continuous advancement. 32 instructors. Unexcelled equipment. 23rd successful year. 17,000 active graduates. Highest Type Training. Recognized by Electrical Industry. Nominal Entrance Requirements. Employment Service during and after training. California spending \$100,000,000 in electrical development. Large, illustrated catalog sent Free, Postpaid. Dept. R.N.

NATIONAL ELECTRICAL SCHOOL  
 4004 S. Figueroa, Los Angeles

E.C.A. DRI-LINE "A" Eliminator, 60 cycle, 110 V., output 6 Amps, 6 V., No Battery—SILENT—\$16.00; "B" Eliminators New Line K, 150 volt, 40 millamps, 4 taps; "C" bias, with 280 bulb, \$10.00; Model KW, 180 volts, 60 millamps, 5 taps, 280 bulb, \$11.75; 5.0 V. taps for power tube filaments "A-B-C" Eliminator, one unit, 3 A., 6 V., "A" side, 180 volts, 5 taps, 60 millamps; "B", 4.5, 27, 40 V. "C." DRI-LINE type, complete, \$20.00. 2 amp. "Z" metal electrolytic charger, \$6.50; 2 amp. DRI rectifier, screw base, \$2.25. Underground Aerials—no lightning hazard, \$3.00; Shield grid sets, parts, supplies. Dealers wanted Catalog 58. Above guaranteed 2 years, with 10 days' trial Electro-Chemical Co. of America, Indianapolis, Ind.

## Make Your Set a Modern A. C. Power Receiver

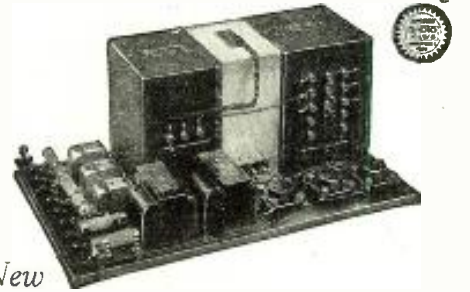

### New AMPLIPACK

A Complete A. C. Power Supply—"A" and "B" and "C"—Makes any D. C. Set into an Ultra-Modern A. C. Receiver. Uses two 210 type tubes in Push-pull; or one of the new 250 type tubes. Power Amplification gives perfect reproduction over the entire musical scale range.

#### QUICKLY ASSEMBLED

You can assemble an AmpliPack easily in one evening. We supply complete layout diagrams. Simple to install. Attached to set in three minutes. Consumes no more current than an ordinary 50-watt light. Cool, quiet, dependable.

#### ASK YOUR DEALER

Leading dealers can give you full details and our simple assembly diagrams. Don't be satisfied with out-of-date reception—build an AmpliPack tonight!

#### FREE Booklet

Write for our new Free Booklet—the latest word on Power Amplification and A. C. Conversion.

### TRANSFORMER CORP. OF AMERICA

1428-1432 Orleans Street, Chicago, Ill.  
 Manufacturers of the T. C. A. Line of Power Transformers, Audio Transformers, Chokes, Power Packs and Power Amplifier Packs.

**Set Builders Dealers Catalogue**  
 FREE  
 Big Catalogue

Send postcard for new catalog and discount sheet. Hundreds of bargains in latest Electric Phonographs, pick-kits and parts at liberal discounts. See our new catalog for Television kits and parts. Short-wave sets, kits, parts and other parts. Power Packs, all kinds, including 250-tube and push-pull circuits. Van-Ashe has everything, at big discounts ready for 12-hour shipment.

## Van-Ashe Radio Co.

210 North 10th St. ST. LOUIS, MO.

**Newest Information TO SET BUILDERS**  
 LATEST RADIO GUIDE  
 Elections, football games, big National events will boost radio business this year. Set builders will reap a rich harvest. Barawik service will make you money. Everything in A-C sets, parts, supplies. World's largest radio stocks on hand. Orders shipped same day. Lowest rock-bottom wholesale prices!  
 Mail coupon for free Radio Catalog now  
**BARAWIK CO.** 111E Canal St., CHICAGO, U. S. A.  
 Mail this coupon for Free Radio Guide

Name.....  
 Address.....

Please say you saw it in RADIO NEWS



previously. In the straight output transformer, two windings are used; primary and secondary, in 1-to-1 ratio. The primary is sometimes larger than the secondary, since the impedance of the tube is usually higher than that of the speaker. This is especially true of the electrodynamic speakers when a small actuating coil with a very low impedance is used. The push-pull output transformer is constructed like the push-pull amplifying transformer; here the primary is tapped, so that the two tubes in the last stage may be coupled properly to the speaker.

### Smooth Power Dependent on Tube's Reserve

IN recent years the trend in automobile design has been toward the use of engines having a greater number of cylinders and greater and smoother power. The fact that an engine can develop 75-horsepower or more or has the ability to drive a car at speeds in excess of eighty miles an hour is not the important consideration, because few car owners ever have need to drive their cars at such tremendous speeds. The important fact is that a car which has such reserve power is capable of much smoother action at speeds of 30, 40 and 50 miles an hour than less powerful cars can hope to be at such speeds.

In between the two extremes of the light car of small power and the big cars of tremendous power there are a number of cars of varying degrees of power and smooth running at different speeds.

#### SMOOTHER PERFORMANCE

The same condition holds true in vacuum tubes. The maximum undistorted volume which can be obtained from a 201A-type tube in the last audio stage is comparatively very small. Better quality for any given volume can be obtained with a 112A tube. Still better quality for any given volume can be obtained by using a 171A tube with proper plate and grid voltages.

If more undistorted volume is desired than can be obtained with the tubes already mentioned, a 210 or a 250 tube may be used to provide undistorted reproduction at volumes which would overload the 201A, 112A or 171A tubes.

In radio, as in everyday life, the same principle holds true—"Don't use a midget for a man's size job."

### By-Passing the Grid-Bias Resistance

IN many instances where a resistor is employed for the purpose of obtaining "C" bias or "C" voltage from the "B" power unit, no by-passing condenser is employed. This is an important oversight, since audio-frequency currents must pass through this part of the tube circuit, with the resistor offering serious opposition to their flow because of its straight resistance, and, in the case of wire-wound resistors, the inductance or choke-coil effect as well. In fact, there is an appreciable loss of volume and tone quality in the absence of a by-pass.

There will be an improvement in volume and tone when a by-pass condenser is shunted across any grid-bias resistor. This condenser should have a capacity of 1- or 2-mf., and may be of the low-voltage type. One with a rated operating value of 180 volts is satisfactory.

## Improve Your Radio With These New HAMMARLUND PRODUCTS

### Shield-Grid Coils

Exceptionally efficient low-resistance, space-wound, self-supporting inductance, 2 inches in diameter, for real results with shield-grid tubes.

A high-impedance primary with three taps for desired pick-up and selectivity.

Antenna coupler and R. F. Transformers for use with either .0005 mfd. or .00035 mfd. condensers.

Vertical mounting bracket for small space. Convenient soldering terminals.

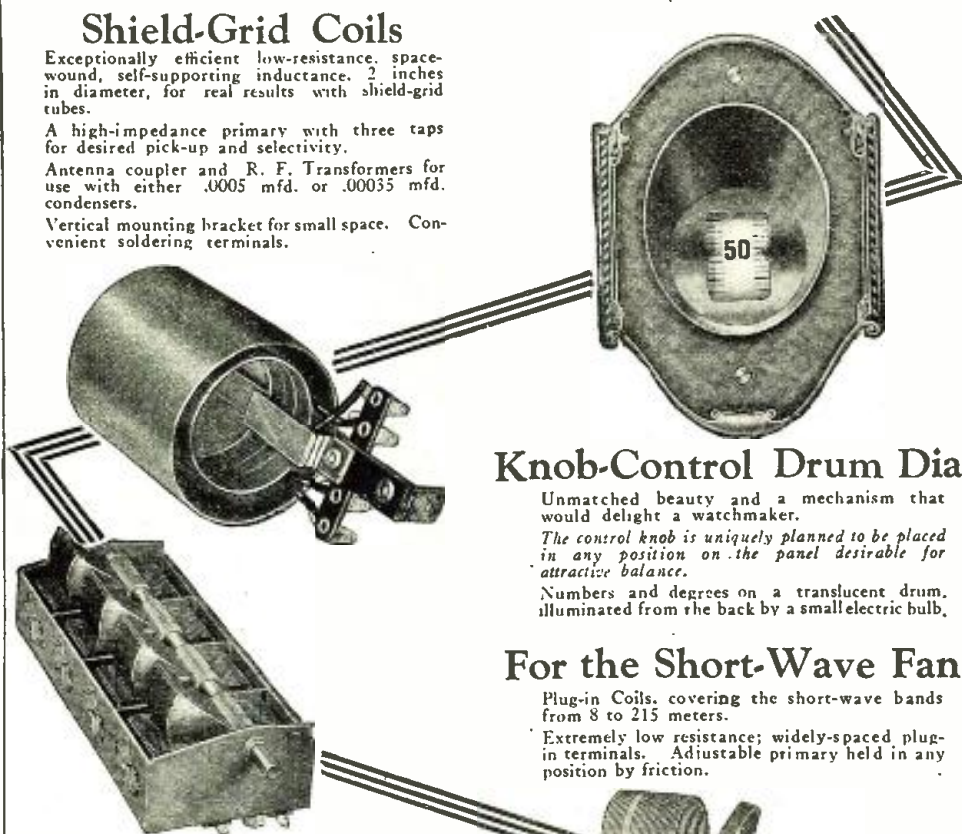

### Knob-Control Drum Dial

Unmatched beauty and a mechanism that would delight a watchmaker.

The control knob is uniquely planned to be placed in any position on the panel desirable for attractive balance.

Numbers and degrees on a translucent drum, illuminated from the back by a small electric bulb.

### For the Short-Wave Fan

Plug-in Coils, covering the short-wave bands from 8 to 215 meters.

Extremely low resistance; widely-spaced, plug-in terminals. Adjustable primary held in any position by friction.

### "Battleship" Multiple Condenser

Leader of the gangs. Built for strength as well as beauty. Die-cast frame; free-moving rotor. Sections accurately matched to within 1/4 of one per cent (plus or minus.) Made in 350 mmfd. and 500 mmfd. sizes, with two, three, and four gangs.

Recesses in the frame permit direct attachment of new type Hammarlund Equalizing Condensers for utmost precision.

Write for literature on these and other new Hammarlund developments.

HAMMARLUND MFG. CO.  
424-438 W. 33rd St. New York



For Better Radio  
**Hammarlund**  
PRECISION  
PRODUCTS

## BE A RADIO DOCTOR



If you are interested in radio, the quicker you decide to make radio your life work the sooner you will be assured of success and *Big Money*.  
**\$30 to \$50** Don't stay in an overcrowded business; get into radio. per week isn't unusual for the student "Radio Doctor" to earn during spare hours while learning.

I NEED 1200 MEN AT ONCE FOR CHAIN SERVICE STATIONS

Professional "Radio Doctors" earn big pay and are in great demand. \$3.00 per visit is the usual charge of our licensed "Radio Doctors."  
"Have a licensed Radio Doctor fix it" is the slogan where our men operate.

WRITE TODAY FOR OUR FREE BOOKLET "WHY THE RADIO DOCTOR"

E. W. Parker, Pres. Radio Doctors, Inc., Dept. N2, Essex St., Salem, Mass.

Insure your copy reaching you each month. Subscribe to Radio News—\$2.50 a year  
Experimenter Publishing Co., 230 Fifth Avenue, N. Y. C.

Please say you saw it in RADIO NEWS

# Books no home should be without

## HOUDINI'S SPIRIT EXPOSES and DUNNINGER'S PSYCHICAL INVESTIGATIONS

By JOSEPH DUNNINGER

In this remarkable new book the voice of Houdini has been resurrected, as though from the dead, and can be heard to echo again in sullen denunciation of the ever-increasing number of spiritualistic mediums who, since his decease, have been parasitically bleeding the innocent public of its choicest possessions whilst posing in the sacrilegious guise of the living dead.

Joseph Dunninger, famous magician, Chairman of the Science and Invention Investigating Committee for Psychical Research and the author of several notable works on magic, was a close personal friend of the late Harry Houdini. All the data appearing in this book was taken from the personal notes of the dead magician now in the possession of Dunninger. These and the accompanying remarkable conclusions drawn from the various successful exposés of Houdini, together with the tremendously interesting revelations contained in Dunninger's Psychical investigations, make this a book that all should read. Over 116 pages. Large 9x12-inch size.

Only  
**50c**  
Per Copy

At all newsstands  
or write direct

## BEAUTY SECRETS

By EVA NAGEL WOLF

This book, by Eva Nagel Wolf, prominent editor of the beauty column of one of the leading women's magazines and internationally known authority, divulges to seekers of beauty the true secrets of their type—just what is necessary to make themselves most attractive. "BEAUTY," says Miss Wolf, "is not difficult to obtain once you have learned the simple secrets of type." It is the purpose of this book to pass on to every woman these secrets—to show her the quickest and easiest way to genuine beauty and attractiveness.

There is nothing left unsaid—every phase of beauty culture is fully treated. The art of make-up, care of the hands,

the hair, the eyebrows and lashes; adding that extra pound or taking off excessive weight—all is covered.

BEAUTY SECRETS should be every woman's constant companion at the boudoir. Critics the country over have claimed that a fair price for a book of this kind would be from three to five dollars. However, due to our unique way of publishing, we are able to give this book to you at the phenomenally low price of—

**50c**  
Per Copy

Sold at all newsstands or  
write direct—112 pages—fully  
illustrated—large magazine size

## POPULAR CARD TRICKS

By WALTER B. GIBSON

Pleasant Entertainment for All

Walter B. Gibson has written what is conceded to be the most complete book of card tricks ever published. There are literally hundreds of these clever little tricks. You need not be a professional in order to work them out. There is no sleight-of-hand required. You can do any of them with little or no practice. Simple to perform—difficult to guess. Complete instructions—hundreds of illustrations.

Once you have mastered a few of the tricks that this book contains you will become extremely popular—always entertaining. Imagine the fun you can have at a party. Just nonchalantly pick up a deck of cards and inquire if anyone has "seen this one." Then, while all attention is focused on you, do these tricks one after another to the admiration and wonderment of all.

This big book of entertainment,  
fully illustrated—large  
magazine size

Only  
**25c**  
Per Copy

At all newsstands  
or write direct



**EXPERIMENTER PUBLISHING CO., Inc.**

230 Fifth Avenue  
New York, N. Y.

-----  
**EXPERIMENTER PUBLISHING COMPANY, Inc.**  
 230 FIFTH AVE., NEW YORK, N. Y.  
 Gentlemen: I desire in the books checked below and an enclosing \$.....  
 full payment of same.  
 Houdini's Spirit Exposés  
 Popular Card Tricks  
 Beauty Secrets  
 Name .....  
 Address .....  
 City ..... State .....

Please say you saw it in RADIO NEWS

## Radio Wrinkles

(Continued from page 455)

the size of drill required. The mounting screw for which a hole is to be drilled is fitted into the various sample holes until the proper size is found; and then a drill which will fit this hole may be found by referring to the marking in front of the hole or by experiment.—Contributed by D. Goodenough, Richmond, Ind.

### A Neat Panel Light Easily Made

FANS who have radio receivers using the old-type non-illuminated vernier dials are often faced with the problem of lighting the front panel of their sets. In this connection it should be pointed out that an inexpensive yet neat panel light may be made from a standard brass drawer-pull, a 6-volt, 4-candle-power automobile lamp and a piece of sheet brass.

The first step in the construction is to cut a mounting plate out of the piece of sheet brass; the mounting plate should have the same width as the drawer pull and should be about one inch high. Three holes must be drilled in the mounting plate; two have a diameter of 1/8-inch and are located in the lower corners, so that they correspond to the holes in the drawer pull, and the third has a diameter of 11/16-inch and is located in the center of the plate. Notches are filed on opposite sides of the large hole, to allow the pins of the lamp to pass through. Next, holes identical with those in the plate are drilled in the panel of the receiver; the mounting plate may be used as a template.

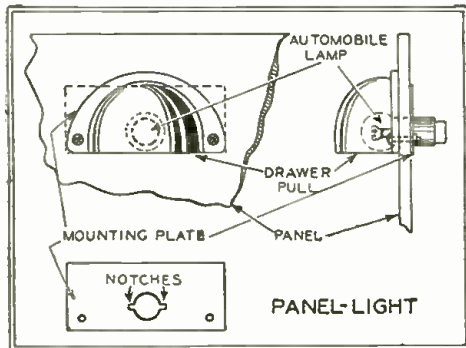

Fig. 7. This bit of hardware will be a neat addition to a home-made set which uses old-style plain dials. It will serve the purpose of illuminating the scale, as well as show that the set is turned on.

After the holes described above have been drilled, the panel light may be assembled. First, the socket is slipped through the hole in the mounting plate and soldered in place, with the shell projecting through about 1/4-inch. The socket is slipped through the hole in the panel, and the lamp inserted in the socket. To complete the assembly, the drawer pull is placed in position and, together with the mounting plate, it is fastened to the panel with two machine-screws.

The panel light may be connected in the filament circuit of the set so that it is controlled by the filament switch; thus making it serve as a pilot light as well as a panel light. If, after it has been placed in service, it does not provide sufficient illumination, the inside of the drawer pull should be painted with white enamel.—Contributed by George Harvey, Lebanon, Ind.

# Over 60,000

## Townsend "B" Power Units Now in Use -- they must be good!

They ARE good! Besides full tone, clarity and volume, you get the thrill of startlingly clear long-distance reception. Never in radio history has anything given such sensational results for such a low price. UNSURPASSED QUALITY built in with money saved by unified production methods and low merchandizing costs. New thousands of set owners learning amazing value of this Unit.

Utmost economy and convenience. Plug into light socket and forget it. Delivers up to 100 volts on any set on D.C. or A.C.—any cycle. YOU TAKE NO RISK. Sold on real GUARANTEE—it must satisfy or money paid us will be returned.

Complete  
**\$6.85**  
\$1.00 Down  
Balance C.O.D.

**SEND ONLY \$1.00** Fill in coupon and send with only \$1.00. Prove this marvelous value to yourself. Use it ten days. Then if it fails to do everything we say, return it and money paid us will be refunded. Make a REAL receiver of your set.

APPROVED

and passed by the rigid laboratory tests of "Popular Radio" and "Radio News."

From  
**This Month's Mail**

The Eliminator received from you about a year ago has proved a great success on my RADIOLA.  
L. Newlin, Overland, Mo.

Your Eliminator has saved me \$20.00 in "B" batteries already.  
Theodore Olsen, Ogden, Utah.

Your Eliminator is the most wonderful power plant I ever saw. Picked up KRLO, Los Angeles, the first night. Never received this station with 3 "B" batteries. Plenty of volume on loud speaker now.  
Pearl R. Duty, Mexico, Mo.

Have been using your Eliminator for over a year and it has proved very satisfactory.  
Mahlon McFeaters, Johnstown, Pa.

Have had your Eliminator for almost a year now and have found it to be perfectly satisfactory.  
J. W. Nolan, Buffalo, N. Y.

My Eliminator has given first class service for two years.  
J. A. Mailhot, Thorold, Ont.

Eliminator received from you year ago has given me better service than dry batteries I used before.  
H. A. Hirschfeld, Lakewood, Ohio.

I am very well pleased with Eliminator bought from you year ago.  
Ed. F. Tuma, Oklahoma City, Okla.



Attach only  
**\$1.00**  
to this  
coupon

TOWNSEND  
LABORATORIES  
Dept. 25,  
713 Townsend St.,  
Chicago, Ill.

Gentlemen: Attached find \$1.00  
Kindly send at once Townsend "B" Socket  
Power Unit, C.O.D. \$5.85, plus postage,  
on guaranteed 10-day Free Trial.

Name.....

Address.....

City..... State.....

**WRITE  
TODAY**

Send for large, new illustrated Catalog "B-1," showing the latest of everything in radio at wholesale prices.

**Allied Radio  
CORPORATION**  
711 W. LAKE STREET, CHICAGO

**SEND FOR NEW RADIO  
BOOK — IT'S FREE!**

New hook-ups. This book shows how to make short-wave receivers and short-wave adapters. How to use the new screen grid tube in D. C. and A. C. circuits. How to build power amplifiers, ABC eliminators. Up-to-the-minute information on all new radio developments. It's free. Send for copy today.

**KARAS ELECTRIC COMPANY**  
4038L1-North Rockwell St., Chicago, Ill.

Name.....

St. and No. ....

City and State..... 4038 L1

Insure your copy reaching you each month. Subscribe to Radio News—\$2.50 a year.  
Experimenter Publishing Co., 230 Fifth Avenue, N. Y. C.

Please say you saw it in RADIO NEWS

## Outstanding Reception

Equip your Power Amplifier with a **POTTER CONDENSER BLOCK** and enjoy the pleasure of natural, life-like reception. New tone brilliancy over the entire receiving range. Bass tones become full and rich in quality.



No. T2900  
where one 250  
type Power  
Tube is used  
**\$20.00**

No. T2950  
where two 250  
type Power  
Tubes are used  
**\$22.50**

**POTTER BY-PASS CONDENSERS**  
Withstand High Voltages—  
Highest Quality

No.	Cap.	DC Working Test Voltage	Price
A-1	.1	200V 160	\$0.60
A-2	.25	200V 160	.70
A-3	.5	200V 160	.75
A-101	.1	400V 200	.70
A-102	.25	400V 200	.75
A-301	.1	750V 400	.85



**POTTER CONDENSERS**  
Have Highest Efficiency—  
Longest Life

The Choice of Leading  
Radio Engineers

Ask your dealer for full information

**POTTER MFG. CO.**  
North Chicago, Illinois

### BUILD YOUR OWN EXPONENTIAL HORN



This marvelous 17x21-in. exponential horn with a 96-in. air column can be easily built by any amateur of 1 1/2-in. soft wood, which produces the most wonderful tone quality. We furnish you with a set of **FULL-SIZED PATTERNS**, which have been accurately and scientifically worked out according to the exponential principle. Simply saw out the wood to the size and shape of the patterns and nail and glue together and you have the latest and

#### MOST EFFICIENT TONE PRODUCER

Send \$2.00 for a set of these full-sized patterns and complete instructions, or we can furnish you the **COMPLETE KIT**, which includes the wood cut to fit, the nails, the glue, our large-sized **CONCERT UNIT**, and full instructions. All complete with postage prepaid for \$11.75 in the United States and \$12.75 in Canada.

**RADIO PRODUCER COMPANY**  
1245 Jefferson Bldg. Peoria, Ill.

## Putting the Aerial in Shape

(Continued from page 437)

paper. Cut a slot half-way down the paper and then curve the uncut part in the center. Bend the two tabs up at right angles and push them up under clapboards or shingles; nail with a brad or two so that the guard will form a roof over the lightning arrestor as shown. This will effectively keep water off the arrestor but, if you are in doubt as to the latter's efficiency, buy a good one that is hermetically sealed.

A squeaking or sticky pulley can be lubricated from the ground by tying a piece of oil-soaked rag to the halyard and then raising the rag to the pulley until the oil is squeezed into the wheel bearing. This is shown in Fig. 6 and is a simple remedy.

### A STRONG CONNECTION

The proper way to keep the aerial and lead-in in one piece is shown in Fig. C. Pass a loop through the insulator and then twist this loop back over the aerial. A solid hitch is made, and one that will not chafe away the wire. The twist is shown in Fig. A, which illustrates the frayed condition of a halyard which should by all means be replaced with new rope. Such chafings are caused by too-tight pulleys, rough trees, rotting of the rope, and like causes. Put in new rope, all around, in the fall and you will not find the aerial lying in the snow some nice morning after the worst storm of winter.

Remember that an efficient aerial must not sway, it must not leak its tiny power to the ground in any way, and it must have a sure metallic path of low resistance over its entire length. Give it an overhauling this fall, and your programs will not suffer from neglect later on.

## WRNY Television Programs

(Continued from page 415)

At the receiving end the signals are tuned-in in the normal manner but, instead of being made to operate a loud speaker, are led after A.F. amplification to a neon-gas "glow-lamp" which is fixed behind a scanning disc identical in dimensions and arrangement of its holes to the one employed at the transmitter. This disc also is rotated at the rate of 450 revolutions per minute. The glow tube produces a pinkish glow which varies in intensity in accordance with the electrical impulses fed it; just as a loud speaker produces sound in accordance with the variations of the current flowing through its windings. As the disc revolves, it allows the varying light of the glow lamp to pass through its holes, one at a time, with the result that a continuous series of 48 closely adjoining lines of light is, apparently all at once, visible to the onlooker. These lines are dark at each point corresponding to one where the scanning ray of light in the transmitter hits a dark spot on the subject, and light where the ray hits a light-colored spot. If the transmitting and receiving discs are in perfect step, or "synchronism," with the holes in the receiver flashing past the glow-lamp in exactly the same relative order that the holes in the transmitter flash past the arc light, a recognizable image of the subject's face and form will be visible apparently on the surface of the disc facing the plate of the glow-lamp. (See pages 428-9.)

# \$2,000,000

## and how the Hotel McAlpin is spending it.

An improvement program that will make the McAlpin a **NEW Hotel**—inside and out . . . .

Luxurious **NEW** carpets, draperies and furniture throughout—bright, cheerful, interior decoration—spacious, **IMMACULATE** rooms, all with modern tiled **baths**—high-speed, electric, self-leveling elevators—and a **NEW** type of courteous, efficient hotel service that enthuses the most critical guests.

We invite you to visit the **McAlpin** and inspect the **NEW** rooms—several of which are already completed.

All improvements are being effected without the slightest interruption of service.

**FRANK A. DUGGAN**  
President and Managing Director

# HOTEL M<sup>c</sup>ALPIN

ONE BLOCK from PENNSYLVANIA STATION  
**B'WAY at 34th ST.**

### 50,000 Feet of Radio

50,000 square feet of floor space in a large, modern building devoted exclusively to radio. Tremendous stock of latest kits, parts and sets in improved designs and styles. Write for Catalog "B-1."

**Allied Radio  
CORPORATION**  
711 W. LAKE STREET, CHICAGO

Insure your copy reaching you each month. Subscribe to **RADIO NEWS**—\$2.50 a year. Experimenter Publishing Co., 230 Fifth Ave., N. Y. C.

Please say you saw it in **RADIO NEWS**

A series of eight 48-line images per second is built up, in the Pilot system. Although it has been generally thought that at least twelve are necessary to create the effect of "moving pictures," this slower rate produces the illusion very successfully. As long as the subject does not move back and forth too quickly, his movements are reproduced smoothly and with a barely perceptible jerk. The images certainly will satisfy the radio experimenters, for whose sole benefit the broadcasting is done.

**IMPROVEMENTS UNDER WAY**

As this issue of Radio News goes to press, Mr. Geloso has not quite finished his automatic synchronising system, so this will be described in the next number.

Briefly, his arrangement involves the transmission of a single strong impulse, at the end of each rotation of the transmitter's scanning disc. In the receiver, this impulse will kick over a relay in the plate circuit of the last audio-amplifier tube and this relay, in turn, causes a magnetic device either to accelerate or to retard the receiver's scanning disc. With one stabilizing impulse every revolution, the disc will settle down to perfect synchronism with the transmitting disc; so that the received images will remain automatically "in frame." Without some such means of synchronization, and with only a variable-speed control on the scanning disc, the images have a tendency to wander out of view. For further discussion of receiver problems, see the article on page 422 of this number.

It must be understood that television today is only for the experimenter, who will find it more entrancing as a scientific hobby than radio broadcasting itself. Complete, foolproof television receivers for the public will not be ready for a long time but, meanwhile, the home experimenter can contribute as much to the art of television as he did to the art of broadcasting in the early days, from 1921 to 1924.

The true television broadcasting being done with the Pilot televisor, through WRNY and W2XAI, must be distinguished from the "radio movies" being transmitted by C. Francis Jenkins and also the "radio movies" recently demonstrated by the Westinghouse Company, described elsewhere in these pages. In the latter forms of broadcasting the pictures on a roll of motion-picture film are transmitted, *not the images of a living person*. Radio movies, however, offer also an extremely interesting field and, fortunately, the owner of a 48-hole television apparatus can reproduce the Jenkins pictures also.

John Geloso, the chief engineer of the Pilot Electric Manufacturing Company, and the man responsible for the design, construction and successful operation of the Pilot-WRNY television apparatus, is only twenty-eight years old and has been in the United States only four years. He was born in South America, but has spent most of his life in Italy; is a graduate of the University of Genoa, where he studied electrical, mechanical and naval engineering and, before coming to the United States, he followed the profession of a naval engineer.

Mr. Geloso has been with the Pilot company for the past three years; and five months ago he was assigned by Mr. I. Goldberg, president of the company, the staggering task of designing a practicable television transmitter that would stay within 5,000 cycles. Within five days from the time

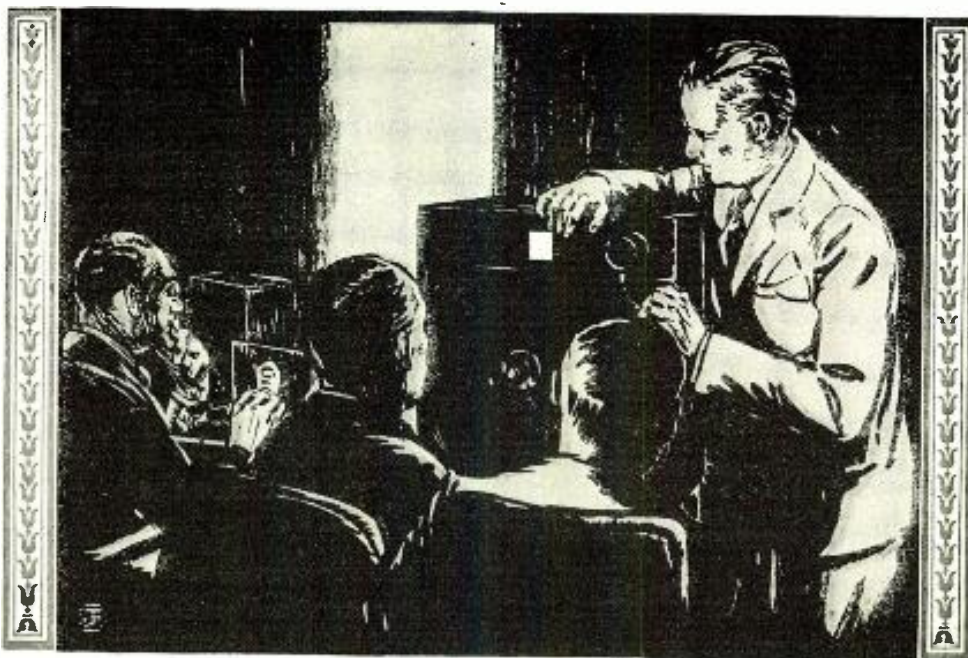

# Television—

## At First Hand

Jules Verne, in his famous "Twenty Thousand Leagues Under the Sea," written in 1870, accurately predicted television. Captain Nemo, the mysterious owner of the great submarine, had worked out the scientific application of seeing at a distance.

Many years have passed since the novelist's prophesy. All that time scientists and inventors have been striving to make television a reality. Every now and then for the last two or three years you have probably met some one who had a friend who had witnessed television. Somehow or other you never saw the witness himself. The information was always second-hand.

Now we have advanced. Television is being accomplished. You may have

seen it yourself and experienced the tremendous thrill which comes from seeing a weaving pattern of luminous spots of light shift and whirl, then suddenly, as the revolving disk reaches the proper speed, resolve themselves into a clearly defined moving image which can be recognized by everyone. This modern miracle makes you think of nothing so much as a great Genie of the Arabian Nights forming itself out of a cloud of smoke from a jar, just opened.

First-hand television is here and available to all.

National Company, Inc., has developed new and better equipment for the construction of short-wave receivers and audio amplifiers of the type required for successful, experimental television reception. Write today for Bulletin No. 128-R. F.

# NATIONAL RADIO PRODUCTS

NATIONAL · CO · INC · W · A · READY · PRES · MALDEN · MASS

Improves any set.  
Easy to install.



Neat, compact, durable.  
Moderate in price.



"The Perfect Contact Radio Ground"

Patent Applied For

PER-CON MFG. CO.

Richmond, Indiana



(ACTUAL SIZE)  
500 to 5,000,000 ohms

distributed capacity and inductance practically negligible. The most accurate and efficient resistance unit known to radio. Write for booklet D. DAVEN CORPORATION, Newark, N.J.

## FREE RADIO GUIDE

Radio has been changing so fast lately that it's hard to keep up with it. Barawik's Big Radio Guide will keep you posted on the newest wrinkles. Thousands of illustrations of sets, parts, new ideas. Big chance to save big money. Send for free copy now.



**BARAWIK CO.** 21CC Canal Sta. CHICAGO, U. S. A.

Please say you saw it in RADIO NEWS

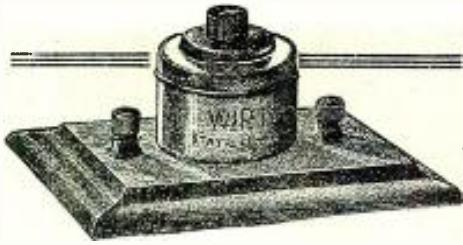

## Cut out squeaks and squawks with Wirt Static Filter

Only \$2.25. Guaranteed to filter out practically all usual static noises—or get your money back. Sharp selectivity. Sweetens tones, including high soprano. No distortion; volume stays the same. Fits any A-C or battery set, anywhere. Easy to install and adjust. Get one!

## Save Your Tubes

with Wirt Voltage Regulator. A-C tubes and sets do best on 110 volts. Normal voltages are higher and there are frequent current "surges". Wirt Regulator admits only an even, constant flow into the set. Saves tubes and set from being burned out. Suppresses line noises, too. Only \$2.25.

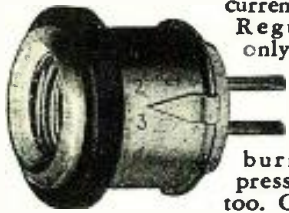

## Lightning Protection

Wirt Lightning Arrester safeguards not only the radio set, but all its parts, too—and, in any weather. Gives peace of mind during electrical storms. Easy to put in place. Stays rigid. Good looking. Only \$1.00.

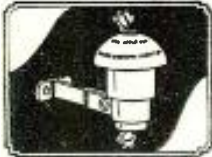

Any radio dealer can get you Static Filter, Regulator, and Lightning Arrester. Or send check—we'll ship postpaid by return mail.

## WIRT COMPANY

5221 Greene Street Philadelphia, Pa.  
Makers of "Dim-a-lite" and "Dim-a-Lamp"

## Set Builders

Write us for new illustrated Catalog "B-1," containing all the new and popular kits in radio. Our tremendous stock enables us to give you immediate service on all radio supplies at wholesale prices.

## Allied Radio CORPORATION

711 W. LAKE STREET, CHICAGO

**BIGGER Radio Guide**

**LATEST RADIO GUIDE**

Keep pace with radio's newest ideas—A.C. sets, tube, dynamics, television, scores of new developments. Since radio's dawn Barawik has kept ahead by bigger stocks, better service, lowest prices. Barawik's Big New Radio Guide is now ready—send for it.

Wholesale discounts to set builders, dealers and agents.

**FREE** BARAWIK Co., 211 DD Canal St., Chicago, U.S.A.

he obtained suitable photoelectric cells, he had a complete transmitter and test receiver working in the Pilot laboratories in Brooklyn and, the first time he turned the apparatus on, a crude but recognizable image appeared in the receiver.

With a regular television service now under way at WRNY, Mr. Geloso is perfecting numerous details of the system, such as automatic synchronization, proper control and mixing of the outputs of the photoelectric cells, the design of a small motor for the receiving disc, etc. Further news of his accomplishments will be published in forthcoming numbers of RADIO NEWS.

## Reception of the Jenkins "Radio Movies"

(Continued from page 420)

### SIMPLE SYNCHRONISING DEVICE

A very simple and practicable method of adjusting the speed of the scanning disc of a television receiver is suggested by the Jenkins Laboratories in a recent bulletin which they have issued to radio experimenters. The idea is to support the disc on any suitable set of bearings, and to drive it by the friction of a small wheel (attached to the shaft of a motor) pressed against its surface. By varying the distance between the friction wheel and the center of the disc, the experimenter can find a setting at which the disc turns at exactly the same rate of speed as the transmitting disc. At different positions on the radius of the disc, the circumference of the friction wheel bears different "reduction-ratios" to the circle of active contact; so, naturally, it drives the disc at different speeds. (See page 420.)

In this arrangement, the driving motor should be run at its natural speed, without being controlled externally by a rheostat. Once the correct position has been found, the motor should be clamped in place, or at least the position noted accurately so that the proper setting can be made quickly. Using a 48-hole disc, a television experimenter can find two positions of the motor, for 900 and 450 revolutions per minute (the former will be at half the distance from the center, except for slippage), and then will be able to receive either the Jenkins or the WRNY broadcasts, respectively, without other change. This scheme is considerably cheaper and more flexible than one involving the use of gears, which require accurate mounting and alignment.

If you already have a scanning disc mounted on a motor, use the latter merely as a support for the disc and drive the disc itself with another small motor of 1/20- or 1/16-horsepower, say. A suitable mechanical arrangement of all the parts used in a complete television receiver is shown in the illustration on page 420. The details are all obvious; the actual dimensions of the wooden members supporting the motors and the glow lamp will depend, of course, on the particular apparatus the individual experimenter has on hand.

### CAREFUL ADJUSTMENT DESIRABLE

The friction wheel may be made of two discs of rubber cut from an old inner tube; they should be about 2½ or 3 inches in diameter, and will work best if clamped between two brass or iron flanges, one of which fits over the motor shaft. The flanges

# CARE SHOULD BE TAKEN IN CHOOSING LOUD SPEAKER

*Acoustic Engineers Recommend Use of Book by Well-known Authority for Instruction*

"The necessity for care in choosing a loud speaker cannot be over-estimated," say acoustic engineers. A radio is but the vehicle used to bring in broadcast entertainment, the true reproduction of sound depends almost entirely on the speaker. It follows, if the loud speaker does not meet the requirements of the receiver, reception will not be at maximum. Consequently the entertainment of the listener-in is often unwittingly spoiled by failure to recognize the importance of a good speaker in getting maximum results from his set.

Education of the public in speaker construction and design is necessary according to these experts. They recommend "HOW TO BUILD MODERN LOUD SPEAKERS," written by Clyde J. Fitch, as being the most efficient source from which this information may be obtained. The book is written in a style that is not only tremendously interesting but also decidedly easy to read. "HOW TO BUILD MODERN LOUD SPEAKERS" is the most complete treatise of its kind available. It thoroughly explains every known type of speaker and gives full instructions for building. It is well to remember that if the proper speaker is not used the enthusiast leaves himself open to all manner of distorted reception. Crackling noises, fryings, whistles and squeals—these disturbances, often laid to the set, can in reality usually be traced to the speaker. Also the fact that a speaker works well with one set and not with another is no reason to lay faulty reception to the set. "So," the experts point out, "you must understand the speaker if you are to receive the maximum results from your receiver." "HOW TO BUILD MODERN LOUD SPEAKERS," by Clyde J. Fitch, is not only the best source from which to obtain this essential information, but also probably the cheapest. Complete, dependable data on every speaker known in radio—full instructions for building. All this for only twenty-five cents, the price per copy of "HOW TO BUILD MODERN LOUD SPEAKERS," by Clyde J. Fitch. Mail this coupon to Conrad Company, Inc. 230 Fifth Avenue, New York, N. Y.

CONRAD COMPANY, INC.,  
230 Fifth Avenue, New York, N. Y.

Gentlemen:

Enclosed find twenty-five cents, for which please send me a copy of "How to Build Modern Loud Speakers," by Clyde J. Fitch.

Name .....

Address .....

City.....State.....

Please say you saw it in RADIO NEWS

should be only about one inch smaller in diameter than the rubber discs, in order to prevent the edges of the latter from folding over when they are pressed against the scanning disc.

It will pay the experimenter to have these flanges turned out for him by the local machinist, or by the garage man if he has a lathe; they will cost only a dollar or so, and will be well worth their price. Unless these flanges fit the driving motor's shaft smoothly, the rubber discs will wobble and will make the scanning disc wobble also.

Use any small induction or synchronous motor that is obtainable. Universal motors which spark excessively at the commutator should be avoided; as this sparking will affect the neon-gas glow-tube and cause spots to appear in the images. However, this interference can generally be eliminated by a pair of ordinary 0.5- or 0.1-mf. by-pass condensers connected in series, and across the motor brushes, with the center connection of the condensers going to the ground lead of the radio set.

Naturally, the only way to determine the proper position for the driving motor is to tune in the television or "radio-movie" signals from WRNY-W2XAL, or from 3XK (the Jenkins station on 46.7 meters), and to turn the adjusting screw shown in the diagrams until the images appear. A little patience is required for this adjustment; if you do not obtain pictures on the first trial, try again.

## On the Short Waves

(Continued from page 457)

### SHORT WAVES AND BROADCAST LISTENERS

Editor, RADIO NEWS:

The letter entitled "Short-Wave Reception on a Standard Ultradyne" in Radio News for September (page 254) deals with a matter that is surely not new to anyone who has ever operated a superhet within a few miles of an amateur transmitter. The fact that most any superhet (and particularly the Ultradyne) has this failing is never mentioned in the "how-to-build" articles, probably due to the commercial slant of these articles. In many instances the publishers seem to deliberately connive with the advertisers to "work" the reader by failing to tell the whole story. However, the tendency of the Ultradyne to suffer from its own oscillator harmonics was mentioned in Q.S.T. at least three years ago.

With my own superhet (just the ordinary nameless standard variety) I found some time ago that it was the third or fourth oscillator harmonic that was heterodyning the short-wave signal to the frequency of the intermediate transformers; and thus permitting the short-wave signals to "come through" on broadcast settings of the oscillator dial. Practically every superhet owner in this vicinity has the same complaint.

There are a number of methods of partially overcoming the difficulty:

(1) Suppressing the undesired S.W. signal in the loop by mounting a tunable absorption circuit on the loop frame. (Who ever heard of a real superhet that required more than a loop for coast-to-coast reception?)

(2) Suppressing the undesired oscillator harmonic by surrounding the pick-up coil with a tunable absorption circuit.

(3) Suppressing the S.W. interference at its source by applying the homeopathic treatment ("like cures like") to the amateur operator who persists in going on the air before 11 p. m. or a Sunday afternoon while the rest of the city is enjoying the broadcast programs. Most anyone past the radio kindergarten "knows how."

Only "one-way" communication soon sends the troublesome operator to bed and permits the rest of the city to again turn on their receivers. An even simpler way is to make friends with the family next door to the "source" and arrange with them to turn on the vacuum sweeper upon phoned request. If they own a receiving set the phone call is unnecessary.

(4) It has been claimed that reducing the oscil-

# Faithful Radio Servants

## ELECTRAD RADIO CONTROLS

They are the guardians of your radio—protecting it against fluctuating voltages, controlling volume smoothly, eliminating oscillations—assuring the highest order of performance for whatever radio function they are used.

Electrad specializes in a complete line of such resistance controls for all radio purposes including Television. They are obtainable at your dealer's.

### TRUVOLT

U.S. Pat. 1676869 and Pats. Pending 1

#### ALL-WIRE RESISTANCES

Admittedly superior for control of voltages in B-Eliminators.

Truvolt Variables simplify B-Eliminator construction by eliminating difficult calculation and making all adjustments easy. Truvolt Fixed are adjustable to different set values by the use of sliding clip taps—an exclusive Truvolt feature!

### PHASATROL

Reg. U.S. Pat. Off.

#### A True Balancing Device for Radio Frequency Amplifiers

Licensed by Rider Radio Corporation

Phasatrol is an unusually efficient device for controlling radio frequency oscillations and thus eliminating the disturbances to reception which they cause. Adapted to any type of receiver using R. F. amplification. A wonderful improvement for the new A. C. circuits where the elimination of oscillations is often a serious problem. Price \$2.75 each.

### ROYALTY

Exclusively Licensed by Technidyne Corporation Under U. S. Patents Nos. 1593658, 1034103, 1034104

#### VARIABLE HIGH RESISTANCES

Recommended wherever a variable high resistance free from inductance and capacity effects is needed. Unusually accurate and dependable. The range of resistance covered in one turn of knob. 11 types to meet every radio purpose.

Electrad, Inc.  
Dept. N-11,  
175 Varick  
St., New York

Please send me descriptive circulars on the following products and put me on your mailing list for similar literature.  
... General circular.  
... Tonatrol Volume Controls.  
... Phasatrols.  
... Royalty Variable Resistors.  
... Electrad Control Manual.  
(Enclose 10c for mailing).  
... "What B Eliminator Shall I Build?" (enclose 10c for mailing)

I am particularly interested in.....

Name.....  
Address.....  
City..... State.....

Mail Coupon for FREE Circulars and Full Information

# ELECTRAD

Inc.

### This handy book should go with every Radio!

It is concerned with radio parts—their functions—where they are—and their names. It gives the symbols used in radio hook-ups, so that you will be able to read any diagram and understand it. It discusses air waves—the aerial—then takes you through every radio part—and finally the actual reproduction of sound.

This is a book that will give you a full understanding of your set.

**ALL ABOUT RADIO PARTS**  
5 1/2 x 7 1/2 inches, fully illustrated  
Get it from any newsstand or direct  
**THE CONRAD COMPANY, INC.**  
230 Fifth Avenue New York City



### FREE BOOK

New Hook-ups. This book shows how to make Short-Wave Receivers, and Short-Wave Adapters.

How to use the new screen-grid tube in D.C. and A.C. circuits.

How to build Power Amplifiers, and A.C. Eliminators. Up-to-the-minute information on all new radio developments.

Set Builders, Fans, Dealers, send for it today!

**KARAS ELECTRIC COMPANY** 4038L2  
4028L2 N. Rockwell St., Chicago, Illinois  
Please send me your Free Book!

Name.....  
Address.....  
City..... State.....



Write for it!

# Improved Positive Voltage Control for Radio Power Units

The new Centralab Heavy-Duty Potentiometer is all wire wound and will carry the entire output of any "B" power device with an unusually high margin of safety. Resistance remains constant at any knob setting, so that panel or knob can be marked in volts. A single turn of the knob will give full variation.



Has sufficient current carrying capacity to permit shunting a low resistance value across the "B" power unit to obtain constant voltage regulation. A sufficient current load is maintained throughout the resistances to reduce the rectifier voltage to workable pressure, even though set is not connected—an insurance against filter condenser breakdown.

Write for folder giving details of this circuit.

Resistances: 2,000, 3,000, 5,000, 8,000, 10,000, 15,000, 20,000, 50,000. Price, \$2.00, at your dealer's, or C. O. D.

CENTRAL RADIO LABORATORIES  
20 Keefe Avenue, Milwaukee, Wis.



# DRESNER SHORT-WAVE CONVERTER

WAVE-LENGTH RANGE  
15 to 550  
Meters



COMPLETE  
\$22.50  
(SPECIAL)

May be used with any type of broadcast receiver. Easily connected in just a few moments' time. No complicated wiring. Simply plugged into the detector socket in the set. Covers the entire range of wave lengths from 15 to 550 meters. Maximum satisfaction from top to bottom. Don't miss the excellent programs now being broadcast on the short waves. Get a Dresner Converter. Five interchangeable coils furnished with each unit. If your dealer can't supply you, Send Money Order Direct and we will ship P. P. Prepaid. Guaranteed. (When ordering unit, be sure to specify whether it is to be used on A.C. or D.C. set.)

DRESNER RADIO MANUFACTURING CORP.  
640 Southern Boulevard New York, N. Y.



Matchless bargains in radios and accessories. Full line of Sleeper, Browning, Drake, Carter, Utah, Tower Speakers, Temple, Majestic, Kodak, G. E., Tuner, Burgess, Jewell, Belden, Cunningham tubes, nationally advertised parts, storage batteries, chargers, etc. Big opportunity for live ones who can sell radio. Double sales quota. Use your letterhead. Exclusive territories open. Act—NOW!

NEW ENGLAND MILLS COMPANY  
Distributors of Nationally Advertised Radio Lines  
Dept. R200 851-55 Washington Blvd. Chicago, Ill.

**RADIO FUSE**  
PREVENTS DAMAGED TUBES, COILS,  
B BATTERIES AND ELIMINATORS.  
OAKPARK MFG CO BOX 324 OAK PARK, ILL. 25¢  
FUSES 10¢

latter plate voltage will reduce the intensity of the harmonics, but it has been the writer's experience that the fundamental is reduced in the same proportion.

(5) The shorter the wavelength of the intermediates, the less the likelihood of annoyance from short-wave stations. This is a strong point in favor of the "neurohet" recently described in RADIO NEWS, the description of which was indeed a genuine "how-to-build" article—an article written for the benefit of the reader rather than the advertiser.

W. J. K., Salina, Kansas.

(The above calls for comment. The short waves are now being drawn upon by not only the amateurs, for whom the writer of the above "has it in," but also governments, commercial radio services, public utilities, broadcasters, televisors, and others. The high frequencies will be used at all hours of the day and night, extensively; the entire wave-range, from the highest to the lowest, will be filled. The broadcast listener must therefore soon be prepared to obtain a set which will tune exclusively to one wave-range, not merely one channel in each range; for the ether will be full of harmonics as well as harmonies. As for the amateur, the law which requires him to keep within his own definitely, and now more narrowly limited channels, also forbids and provides penalties for the creation of intentional interference in the manner prescribed as his third recommendation by our correspondent. Our advice is, DON'T!—EDITOR.)

### NO SHOCK AT ALL—IT'S JUST LUCK

Editor, RADIO NEWS:

I have built the "Junk Box" receiver described in RADIO NEWS for July (Blueprint No. 58) and this is to prepare you for a shock. The set was built as described about three weeks ago and is used very night with an adapter plugged into a two-stage amplifier. I get practically all the short-wave stations using phone and code. But every program is clear of static. I have tested the set during thunderstorms; and music, speech or code came through without the crashes usually heard from lightning. I want to know if this is usual or unusual for a short-wave set.

This is a pretty broad statement. I expected less static on short waves; but cannot understand why I get none—not even lightning.

L. E. PLATT.

(Short waves are usually free from static than the longer ones; wherefore the growing demand for short-wave stations and apparatus, especially in the tropics, where static was invented. Except for local disturbances, therefore, there is less static; but our correspondent is highly favored if he hears none at all. He fails to state what his antenna system is.—EDITOR.)

### A SHORT-WAVE SET WITH LARGE CAPACITY

Editor, RADIO NEWS:

Enclosed find a diagram of the short-wave set I have constructed which I find to be quite efficient, and has some new pointers. First, I use as a regeneration control, a resistance of 200 ohms to 30 megohms. This will have to be of the non-microphonic type and also be noiseless over the entire tuning range. The one used in my set was manufactured by the Pilot Electric com-

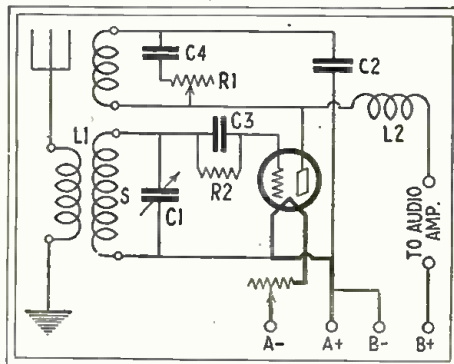

The hook-up of Mr. D'Angelo's set. A fixed regeneration condenser is employed, with a variable resistor as a control.

pany. Second: Instead of the usual 7-plate tuning condenser, a 23-plate De Jur straight-line condenser of .00035 capacity was used. This gives me good volume with oscillations over the whole dial at all wavelengths, with little hand capacity. Third: Although my aerial wire is well over 200 feet, no condenser is in series with it.

The following are specifications of the parts

# Learn ALL ABOUT AVIATION

EVERYBODY'S AVIATION GUIDE is a complete discourse on practical aviation, by MAJOR VICTOR W. PAGE, one of the leading men in the field. Unlike most books of instruction, EVERYBODY'S AVIATION GUIDE is written in a unique question and answer fashion, which makes the subject far easier to study and a great deal more attractive as an instruction course.

This book was recently published and is absolutely up-to-date in every way. It has had very favorable criticism throughout country-wide aviation circles and has been highly recommended by all those in a position to pass judgment.

We list here the contents in order that you may see for yourself how completely the field of Aviation is covered.

### Contents:

- Early Aeronautic History—First Flying Machines—The Atmosphere
- Forms of Aircraft—Airplanes and Airships
- Lighter-Than-Air Craft—Balloons and Dirigibles
- How An Airplane Flies—Elementary Aerodynamics
- Airplane Parts and Their Functions
- Fuselage Forms and Landing Gears
- Wing Arrangement and Construction
- Power Requirements, Engine Types and Engine Location
- Aircraft Propellers. Design and Application
- Airplane Equilibrium and Control
- Official World and American Air Records



Price

\$2.00

Over 248 pages  
Beautiful red cloth binding—Title in gold  
Replete with illustrations

WRITE DIRECT TO

CONSRAD CO., Inc.  
230 Fifth Ave. New York, N. Y.

CONSRAD COMPANY, Inc.  
230 Fifth Ave., New York, N. Y.  
Gentlemen: Kindly send me one copy of your book, EVERYBODY'S AVIATION GUIDE  
Enclosed find \$2.00.

Name.....  
Address.....  
City.....State.....



used: L1, antenna coil, 8 turns of No. 18 D.C.C. space-wound 1/4-inch apart, on 4-inch tube for all wavelengths. Up to 50 meters, grid windings, 3 turns of No. 28 wire on 1/4-inch tube. Tickler coil same as above, wound directly over the other.

From 50 meters on, 9 turns of No. 20 wire spaced 1/16 inch apart for secondary, and 8 turns for tickler on a 3-inch tube;

C1, .00035-mf. condenser;

C2, .0002-mf. (This must be accurate);

C3, .0002-mf.;

C4, .0001-mf.;

R1, from 200 ohms to 30 megohms;

R2, 6 megohms;

L2, 140 turns of No. 26 wire on a 1-inch tube, 4 inches long.

67 volts on the plate will be needed for wavelengths up to 50 meters. Beyond that 22 volts will be required for the correct operation of the set. The tube is the usual 201A.

The following stations have arrived regularly: 2XAL, 2XAD, 2XAF, 2XE, WLW, KDKA, WHAM, CKY, 5SW, PCJJ, 3XL, and numerous others. Harmonics of WAAJ, WIIN and WFFF and others were heard. Amateurs in Montreal, St. Louis and California were also logged.

I would like to hear from builders of this set, and hope this information will be of interest to your readers.

EUGENIO D'ANGELO.

69-71 Dundas St. W., Toronto, Ontario, Canada.

**THESE FUNNY WAVES**

Editor, RADIO NEWS:

Many thanks for blueprint No. 58, for the "Junk Box." I have just completed the set and given it a few days' tryout. Following are the results to date:

2XE, good; very clear.

5SW, at times very clear, but much troubled with body capacity. Better at 7 than at 5 p. m. "Big Ben" comes in fine at 7.

2XAL, not so good. Music difficult to follow. Much distortion—still, many thanks for an announcer who announces the station often. At least one gets a chance to locate the station if he misses the letters, with the sentence which follows: "Radio News station, located at the Roosevelt Hotel."

2XAF, heard once, when everything said and done was very clear.

KDKA, at 42.95 meters, better reception than on lower channel.

WLW comes in very clear.

Besides these stations, I have heard, although very indistinctly, the gym classes between 11 and 12 a. m. of WMCA; also a religious service from (I believe) WAAJ. The singing was so dreadful that I tuned out without attempting to get the call letters. Now, this morning, I heard a band playing (very fuzzy) about WLW's wavelength. Is it possible that these were the harmonics of WMBQ, Brooklyn, as the call sounded like these letters? (It is quite possible to get a harmonic, say the fourth, of a broadcast station in this manner; in the station's immediate field, harmonics as high as the thirteenth or fourteenth may be detected. The oddity of short-wave reception is thus indicated; our correspondent, living just across the city line of New York, gets London easily, Pittsburgh and Cincinnati clearly, Schenectady with difficulty, and New York City stations hardly at all. A few miles closer, he would be in their inductive field; and a few miles further away, he would probably be unable to get them at all. The quality, also, of the ground wave is undoubtedly affected by numerous reflections at short distances in the city.)

I have not as yet succeeded in getting a squeal from the largest coil, No. 5. I propose rewinding. I have two aeriols, one outdoors, and one indoors, strung under the room. Reception seems about the same with both; but by disconnecting the ground wire last night, while listening to WLW, reception was improved very much, and static and hum notably diminished.

I built this "Junk Box" set after working long with the hook-up which appeared in Radio News last October. With that I got PCJJ once at 2 a. m.; the rest of the stations, when I could make them out, were very poor. I have certainly got better results with the "Junk Box." Once again, many thanks for the hook-up and blueprints. I trust you will give us more short-wave data. Perhaps your expert could give us a few tips as to how to get rid of howls and body capacity in the "Junk Box."

O. STANLEY HEATON.

Bandmaster, Leake & Watts Home School, Yonkers, N. Y.

(The best way to reduce body capacity in this set is to use extension handles on the condenser dials. Howling is usually a matter to be regulated by better tuning.—EDITOR.)

**NORDEN-HAUCK  
NEW 8 TUBE  
AC ELECTRIC MODEL**



FOR  
1929

Size 8x11x22

Weight 35 lbs.

Wave length range 200 to 550 meters.

**ELECTROPHONIC**

The Norden-Hauck Electrophone is an entirely new and superior broadcast Receiver operating directly from house current. It is well built, handsomely finished and compact. Truly it represents the highest type of efficiency obtainable in point of range, selectivity and simplicity combined with utmost quality of reproduction.

**10 OUTSTANDING FEATURES**

**ELECTRIC.** The Electrophone is all electric operated and self-contained. No Eliminators or batteries whatever. Employs standard Radiotron or Cunningham alternating current tubes.

**CIRCUIT.** The Electrophone employs an 8-tube circuit: three stages direct tuned radio frequency amplification fully neutralized, detector, and three-tube power audio amplifier push-pull type.

**SHIELDING.** The Electrophone is totally shielded. Complete inter-stage shielding permits high amplification not obtainable otherwise.

**SIMPLICITY.** The Electrophone has but one control for wavelengths, one control for volume. Illuminated drum dial calibrated in degrees and in kilocycles.

**SENSITIVITY.** The Electrophone has carefully balanced radio frequency tuning circuits which with superior quality of materials and workmanship combine to make the Norden-Hauck Electrophone a long distance Receiver.

**SELECTIVITY.** In the Electrophone total shielding and carefully balanced circuits and quality permit unusual selectivity so necessary in congested districts.

**QUALITY.** The Electrophone is of the highest quality of construction and design throughout. Comparable only with costly custom built Receivers.

**FINISH.** The Electrophone has an exquisite solid mahogany cabinet, brown finish. Heavy cast bronze escutcheon plate and tuning knobs lend to the rich appearance of the Receiver which will fit in any surroundings. Cabinet high French polish and full piano hinge. Back removable and ventilated.

**GUARANTEE.** The Electrophone material and workmanship are fully warranted against any defects whatsoever.

**PRICE.** The Norden-Hauck Electrophone Receiver is moderately priced at \$125.00. Packed for shipment.

List Price **\$125<sup>00</sup>** f.o.b. Phila.

COMPLETE illustrated literature gratis. Write, telegraph or cable today.

**NORDEN-HAUCK, INC., ENGINEERS**

MARINE BUILDING, PHILADELPHIA, PA.

Builders of the Highest Class Radio Apparatus in the World.



**GEARS**  
All kinds—Small

The most accurate made and prices reasonable. We carry a complete line of gears in stock for immediate shipment. Can also quote on special gears of all kinds. Send us your inquiries. Write for Catalog 40  
Chicago Stock Gear Works  
105 So. Jefferson St., Chicago

**ELECTRICITY** Easily Learned  
IN A FEW WEEKS

Learn with real tools on real equipment. No books, no printed lessons, no dry lectures. McSweeney's SHOP PLAN system of training makes real electricians in shortest possible time. 90 days' training for you for a big-pay job at \$50 a week, and up. Write for big electrical book FREE—also remarkable tuition offer, which includes FREE R. R. fare. I guarantee satisfaction or money back.

**McSWEENEY ELECTRICAL SCHOOLS.**  
DEPT. 76-S, CLEVELAND, OHIO

**DEALERS & SET BUILDERS**  
Complete stock of nationally known parts and accessories. Send for illustrated catalog and discount sheet.  
Radio Exclusively Since 1921  
**CLARK & TILSON, Inc.**  
122 CHAMBERS ST. New York  
The Nationally Known House

**FREE RADIO CATALOG**  
Since the dawn of Radio, Barawik has been known the world over as headquarters for radio set builders and fans. Here, under one roof, is everything you need—sets, parts, supplies—thousands of products—ready to ship to you the same day your order arrives. Barawik prices save you money. Barawik service saves you time. Barawik merchandise always pleases. A quarter million satisfied customers say, "Barawik is Best." Let us send you the Big Barawik Book free and prove it to yourself.  
**BARAWIK CO. CHICAGO, U. S. A.**

# 1929 TYPE A. C. SHIELD GRID BROWNING-DRAKE

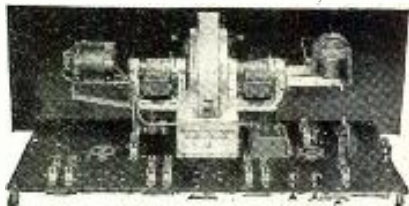

A combination of true single control, without trimmer or variometer, together with A.C. shield grid operation, mark this as the season's foremost Kit. Remember that more Browning-Drakes are built than any other Kit assembly. Full scale constructional data free on request.

**Complete Parts—\$59.45**

Some territory is open for dealers and distributors to handle Browning-Drake factory-built receivers. Write for franchise information.

**Browning-Drake**  
Brighton, Mass.

## Wholesale RADIO Prices on

Get our big new 1929 Radio Catalog—hot off the press. Contains thousands of amazing bargains. Latest, nationally advertised Radio equipment. Latest in Ham Transmission equipment. Everything at lowest wholesale prices.

### NEW RADIO CLUB—Big Prizes

Get all the facts about "Ether Trappers" Club, now. No dues. Many advantages. Write for **FREE** Membership at once.

This Big Book of money-saving bargains is yours **FREE**. A regular Radio encyclopedia. Write today for your copy of this book.

AMERICAN RADIO & MERC. CO.  
Dept. 10  
American Radio Building  
KANSAS CITY, MO.

**\$5.50 buys this famous cabinet**

The Iceryline

Sizes range from 7x18x10 to 7x30x12. Mahogany finish, \$5.50 to \$8.75. Solid Walnut, \$6.50 to \$10.25. F.O.B. Hickory. Twelve-hour service. Write for Catalog.

**SOUTHERN TOY COMPANY, MAN'F'R. HICKORY, N.C.**

### NEWS to Set Builders

**LATEST RADIO GUIDE**

Barawik offers set builders bigger bargains—bigger opportunities to make money this season. New sets, new kit ideas, all the leading parts, dynamic speakers, supplies, etc. Lowest rock-bottom prices. Bigger stocks, quicker service. Send for Big Bargain Book today—free.

**BARAWIK CO.,** 212A Canal Sta., CHICAGO, U. S. A.

### SOME DO NOT

Editor, RADIO NEWS:

To the many thousands of short-wave set builders who have been as unsuccessful in logging far distant foreign stations as I have, I would like to give a "handshake." These boys need more encouragement than the successful ones do praise.

I, for one, have built every short-wave receiver that has appeared in RADIO NEWS, as well as others. For six months I plugged faithfully away, never getting beyond New York, hearing 2XAD, 2XAF, WGY, once in a while WLW and WABC.

The "R.F. Short-Wave Receiver" was built, which was the best one for volume and quality of reception. The radio frequency was not successful for me; this was removed and a B-T detector unit mounted. This was a great improvement, but still no foreign station.

I have corresponded with several short-wave set builders and have tried their suggestions—but to no success. For the amount of blueprints distributed by the RADIO NEWS, the number of successful "foreign getters" must be very few in comparison.

I have spent several hundred dollars, at least three hundred dollars, and still I have lots to learn and receive. I eventually drove a fifteen-foot pipe in the ground and by using the ground for an aerial and no ground, I have been able to tune in every Friday night PCJJ, which is barely audible in the phones. Occasionally it can be heard in the loud speaker. One evening, between 6:30 and 7:30 E. S. T., I picked up a foreign station on the phones that sounded like German. This was on about twenty meters. One afternoon at two I picked up a phone conversation in Italian at about 17 meters.

This is the limit to my success. WGY and KDKA come in with enough volume to be heard a block away—but no foreign station calls at my house.

I have just completed another set in the past two days, using a CX-322, screen-grid tube as a radio frequency amplifier. Last night was the first time I ever heard PCJJ on the loud speaker with sufficient volume that I did not have to strain every nerve. On the phones it was very fine.

A local short-wave expert is now working on my set to eliminate body capacity. He has a set such that you can put your hand on the coils, tubes or inside of the coils and no body capacity is present nor does it reduce the volume. He uses three tubes and gives more volume than the R.F. receiver with push-pull amplification, day or night. By the elimination of the body-capacity effect he increases his volume more than double.

Let's hear from some of the "failures" in the short-wave field as I have been. Perhaps some of the other boys can help them out. It is very disheartening to some I know and I would like to see these boys get a little recognition, for it is one of the most interesting fields of the radio and some may give up.

Thanking you for this opportunity, I am,  
J. W. MANNING,  
Daytona Beach, Florida.

(There are differences between short-wave operation and broadcast methods, and RADIO NEWS will deal with them in a series of articles. It must be remembered that the distant short-wave stations have generally very small power, and that the energy received is very feeble in comparison with that in comparison from American broadcast stations. This necessitates great sensitivity in the short-wave receivers, whose resonance point is very narrow; and it is therefore very easy to pass over a short-wave phone station many times if the exact adjustment is not tried. Slow, patient tuning is needful. It will be noted that there is nothing wrong with Mr. Manning's receiver.—EDITOR.)

### BYRD EXPEDITION CALLS

Commander Byrd's ship, the *City of New York*, which sailed a few days ago for the Antarctic, has been assigned the call WFBT, while its auxiliary portable transmitter is WFA. Smaller portables are KFK, 50 watts, WFD, 50 watts, and WFE, 7½ watts. The airplane *Fairchild* has the call WFS and the *Floyd Bennett* WFI.

In addition to the ship frequencies between 600 and 800 meters, the Byrd expedition may use these short waves: 91.2, 68.1, 53.57 (commercial), 53.10, 45.59, 34.05, 26.78 (comm.), 26.55, 22.75, 17.945, 17.857 (comm.) and 13.758 meters.

### OFFICIAL CORRECTION

The Department of Commerce announces two corrections of the published list of new international call letter prefixes: CA is Chile and HR Honduras. Canadian amateurs will not use CF for the present, but only VE.

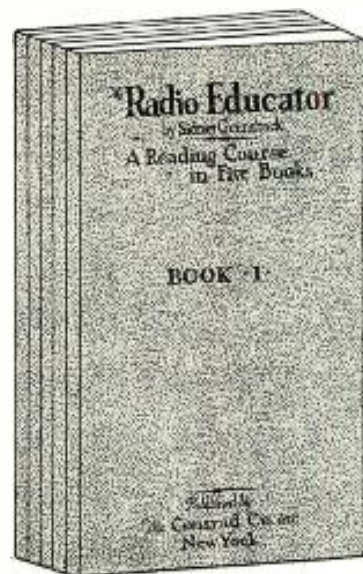

Price \$1.97

# A RADIO EDUCATION IN 5 VOLUMES "THE RADIO EDUCATOR"

Theory, Design, Construction,  
Operation and Maintenance

LEARN AT HOME

THESE five component parts of a complete Radio Instruction Course are outlined in five volumes that contain not merely the essentials as so many books do, but more, they contain all that any modern up-to-the-minute textbook on any subject would cover. They are in themselves a COMPLETE radio education teaching every possible portion of Radio science.

Size of each book 6 by 9 inches, handsomely bound and illustrated with charts, diagrams, descriptions of equipment, etc. Each volume 52 pages.

SEND NO MONEY for these books. Just forward your name and address. We send you the books at once. On receipt of same you pay the postman \$1.97 plus a few cents postage and then they are yours.

Distributed by

**The Conrad Co.**

Incorporated

230 Fifth Ave., New York, N. Y.

**"JUNK-BOX" SET BUILDERS**

Editor, RADIO NEWS:

I am using 199s in the "Junk-Box," and I find them a poor type for short waves. Larger ticklers are required, "B" voltages are more critical, and what-not. However, I am not kicking; the set itself is great. KDKA and WGY come in around noon without an aerial. I have also logged WLW, KWKH and WEDC, Chicago; the latter two apparently harmonics. I would be grateful for any information on this.

I am using 45 volts on the detector and 67½ on the amplifier; a 5-megohm grid leak works best. I find also that a .00025-mf. fixed condenser across the filament terminals of the coil socket helps with some of the coils. Body capacity is bad, but I have on the condensers small shields which lessen it somewhat.

BERT VOGEL,  
1541 White Street, Dubuque, Iowa.

I have made a few changes in the "Junk-Box" set which might be of interest to others who are building this circuit. I made a plug-in adapter for my present three-circuit tuner, in order to use my two-stage amplifier without rewiring. I found that, in doing this, I used the tickler coil of my three-circuit tuner as a radio-frequency choke, and it works O.K. I also picked up an old neutralizing condenser and put it in the aerial circuit. I didn't happen to have the .000032 condensers, so I used .000025s and they work O.K. with the coil specifications. It works better than I ever had hopes for.

WARREN B. BARNES,  
1532 Lincoln St., Hillsboro, Oregon.

I am a "kid" fourteen years old, and a constructor of the "Junk-Box." When I first constructed it, I found that my leads were too long and the set would start to oscillate with a groan. I rebuilt it, and as the howling at the beginning of oscillation was still present, I put a .002-mf. fixed condenser across the "A+" and the "B+ Amp." Finding that the condition was not entirely remedied, I took the wire off the ticklers, turn by turn, and found that the following specifications are best for my set: ticklers, 6, 7, 9 and 16 turns, respectively, for coils 1, 2, 3 and 4. To date I have received WGY and KDKA on the speaker, and 2XAL, 2NE and WLW on the phones; I have received code stations as far as the Pacific coast.

Being a DX hound, however, I am greatly interested in transatlantic reception. I would like to communicate with makers of this set who have had the thrills of transoceanic reception and learn of some details of their sets, such as shielding, antenna construction, etc.; and also with constructors interested in the Browning-Drake receiver and boosters for it. I will try to answer as many letters as I can.

CHESTER TUCHOLSKI,  
1012 Bremen St., Milwaukee, Wis.

**CORRESPONDENTS WANTED**

Editor, RADIO NEWS:

Our radio club desires correspondence with boys between the ages of 13 and 19 who are interested in DX work on both short and broadcast waves. We will answer every letter.

LELAND J. GILLETTE,  
President, Midwest Amateur Radio League,  
7263 Coles Ave., Chicago, Ill.

I would be grateful if I could correspond with some young short-wave ham in Switzerland; or some man of experience who would take interest in a boy.

WAYNE D. DUNN,  
1044 F Ave., Nevada, Iowa.

I would like to communicate with anyone who is interested in short waves.

WILLIAM BUDINGTON,  
958 State St., Springfield, Mass.

The following will be of interest to all short-wave listeners. The transmitter of 3LO, Melbourne, Australia, is using 5,000 watts on 32 meters every Sunday from 1830 to 2030 G.M.T. (1:30 to 3:30 p. m., E.S.T.). ANH, Mt. Malabar, Java, 17 meters, has 40 kw. power. 9 amperes in antenna. ANE, Bandong, Java, 15.93 meters, has 7 kw.; 5 amperes in antenna. Announcements of these stations are made in Dutch, English, French and German.

I would like to correspond with short-wave enthusiasts in foreign countries.

WRAY GILLETTE,  
923 W. Anderson Ave., Ft. Myers, Fla.

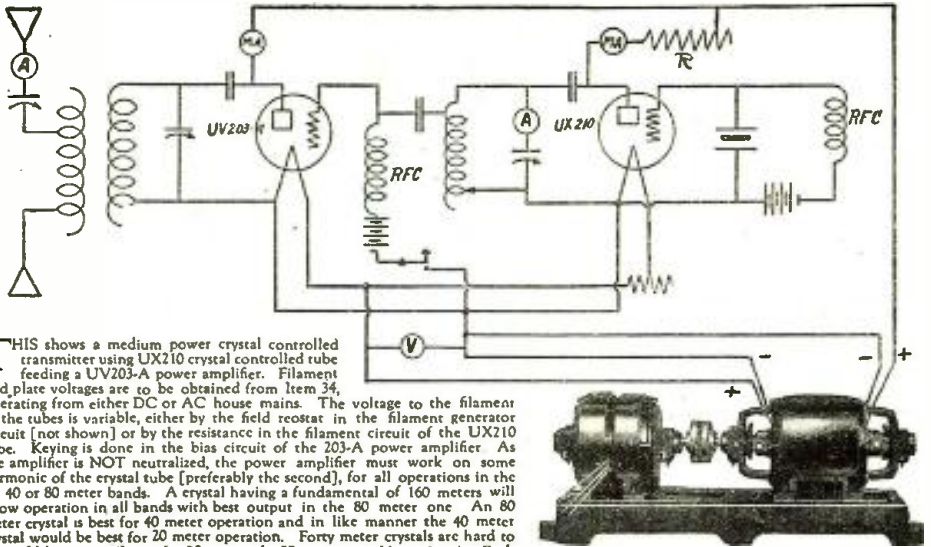

THIS shows a medium power crystal controlled transmitter using UX210 crystal controlled tube feeding a UV203-A power amplifier. Filament and plate voltages are to be obtained from Item 34, operating from either DC or AC house mains. The voltage to the filament of the tubes is variable, either by the field rheostat in the filament generator circuit (not shown) or by the resistance in the filament circuit of the UX210 tube. Keying is done in the bias circuit of the 203-A power amplifier. As the amplifier is NOT neutralized, the power amplifier must work on some harmonic of the crystal tube [preferably the second], for all operations in the 20, 40 or 80 meter bands. A crystal having a fundamental of 160 meters will allow operation in all bands with best output in the 80 meter one. An 80 meter crystal is best for 40 meter operation and in like manner the 40 meter crystal would be best for 20 meter operation. Forty meter crystals are hard to get and blow up easily, so for 20 meters the 80 meter crystal is used again. Both tubes obtain plate supply from the plate end of Item 34, the UX210 being supplied with not over 350 volts through resistance R, and the 203-A taking the full 1000 volts.

**ELECTRIC SPECIALTY COMPANY**

211 South Street  
TRADE "ESCO" MARK  
Stamford, Conn., U.S.A.  
Manufacturers of Motors, Generators, Motor-Generators,  
Dynamotors and Rotary Converters for Radio and other purposes

Send for WESTERN RADIO

# New

## 1929 Catalog

DEALERS AND SETBUILDERS

THE NEW 1929 Catalog is crammed full of the FINEST, NEWEST, nationally-known A.C. sets, consoles, cabinets, dynamic speakers, kits, eliminators, and accessories at LOWEST PRICES. Largest stock of Radio Parts. Prompt delivery. Write for our FREE catalog.

WESTERN RADIO MFG. CO.  
128 WEST LAKE ST., Dept. RN-11 CHICAGO, ILL.

FREE ACWESTRAD 7 TUBES \$29.95

WESTERN RADIO

The Big Friendly Radio House

**A REAL SPECIAL OFFER!**

**UNI-RECTRON POWER AMPLIFIER**

Ideal for use with Dynamic Speakers

Model AP-935

As the Uni-Rectron stands it is a super power amplifier, which can be used in connection with any radio set and loud speaker. Binding posts are provided for input to the Uni-Rectron and output to the speaker.

Requires no batteries for its operation. It obtains its power from the 110 volt, 60 cycle alternating current lighting circuit of your house.

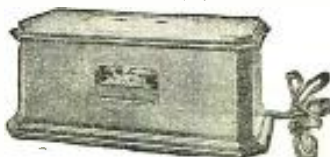

List Price \$88.50  
(without tubes)

Special \$19.75 ea.

Every one new and packed in original factory carton

The UX-210 super power amplifying tube and the UX-216B or 281 rectifying tube are used with this amplifier, which cannot overload. From the faintest whisper to the loudest crash of sound—R. C. A. Uni-Rectron amplifies each note at its true value. High and low notes are all treated alike. The volume and quantity delivered will be a revelation.

AMERICAN SALES CO., 19-21 WARREN ST., NEW YORK CITY  
SEND FOR OUR LIST OF RADIO BARGAINS

Please say you saw it in RADIO NEWS

### Build a Daven Television Receiver

Complete Essential Kit, \$60.00

THE first complete Kit. Furnished with either T-24, T-36 or T-43 Scanning Disk, Motor, Bushing, Rheostat, Daven Television Tube, 3 Complete Stages of Daven Television Amplification and Instructions for Building.

Daven Television Receiver, Complete, including Television Tube—\$100.00 Less amplifier Tubes.)

### DAVEN TELEVISION APPARATUS

Daven Television Scanning Disks	Each
24 T-24	\$ 5.00
36 T-36	7.50
48 T-48	10.00
Comb. Disc with 24, 36 and 48 Apertures T-468	15.00
Daven Tele. Amp. T-5	12.50
Daven Spec. Telev. Amp. T-4 for 2 Hi Mu Tubes and 2 power Tubes 171, 210, 250 Types	17.50
Daven Telev. Neon Lamp, 20 to 80 Milliamperes Stricking Voltage 100 Plate 1 1/2" x 1 1/2"	12.50
Daven Telev. Motor	27.50
Daven Bushing to fit 1/4", 5/8" and 3/8" Motor Shafts	1.00
Daven for 48 Aperture disc	3.50
Daven Rheostat	3.50
Daven Telev. Photo Elect. Cell 1 1/2" Bulb	20.00
Daven Telev. Photo Elect. Cell 3" Bulb	37.50
Daven Television Couplers	
1st Stage No. 421X D-421XX	
2nd Stage No. 422X D-422XX	
3rd Stage No. 423X D-423XX	
x Glasiors are used for Grid and Plate resistors...	2.15
xx Super Davohims in Plate and Glasiors in Grid.	4.65
Daven AC 71 for output tubes in series with Television Lamp	3.50
Daven AC 10 (for brighter illumination)	9.00
Daven Mu 20 Hi Mu Tubes for Amp. Stages	2.25
Daven Mu 6 Power Tube	3.50

Send 2c stamp for new Television Booklet

**THE DAVEN CORPORATION**  
Amplification Specialists  
163 Summit Street Newark, N. J.



## The Radio Constructor

(Continued from page 459)

### BETTER USE PHONES

Editor, RADIO NEWS:

I made the Loveless antenna exactly as directed, connected the coils as per diagram, and all I received was dead silence. I reversed the connections to see what would happen, and again received nothing.

I threw off the ground connection of coil, and immediately received very weak locals. Catching hold of the ground and of the aerial, I found a great increase in the strength of signals if I squeezed the end; signals weakened if I merely touched the end. I tried this with an old two-tube Crosley connected to a three-tube Sonatron amplifier. I received WOR, WENR and KFI, stations I never had before.

I took the antenna upstairs and connected it to a three-tube Bremer-Tully hook-up, and the result was again dead silence. Back to the basement, and the stations mentioned were again heard with the Crosley.

I then tried the Loveless antenna in connection with a Freshman lamp-socket aerial at the "ground" end, and succeeded in rousing the whole house with WENR's new transmission.

That ended the experiments, for wrathful noises began to emanate from the upper regions; my wife, who calls herself a radio widow, began a series of interferences with home-made static which sounded like: "Fancy having that going at 2:30 in the morning like a locomotive!"

JAMES HATTON,

107 Ennerdale Road, Fairbank, Toronto, Can.  
(Even discoverers must have some consideration for the neighbors. The latter occasionally need sleep. As to the Loveless antenna, variations in the resistance of the ground connection, as well as in the inductance and capacity of the device, are apt to produce very different results for different experimenters. However, like Mr. Hatton, they may get lots of fun trying. We suggest a test with a variable condenser across the two open ends of the windings.)

**INQUIRIES** for information not given here should be sent to the constructor direct; but he should NOT be asked to furnish data already published, here or elsewhere, or for instructions that an experienced builder should not need.

This department is for free discussion to the extent that space permits; but RADIO NEWS accepts no responsibility for the opinions of readers as to the relative merits of apparatus and circuits.

### A HALF-GALLON ANTENNA

Editor, RADIO NEWS:

The article on Mr. Loveless' aerial caught my eye, and I had to have one like it. Instead of getting a large tube, I used two-quart Sealright containers and some No. 26 D.S.C. wire. I wound 225 feet of wire on each of the tubes, both of which are 7 inches high. The outer is 3 1/2 inches in diameter; the inner was slit and lapped to reduce it to 3 inches.

I have a six-tube T.R.F. set and a five-tube Freed-Eiseman and have had fine results on both; but lately radio reception here has been rotten and static awful. With the aerial as described on the T.R.F. I logged WEF, WJZ, WOW, WRR, KTHS, several Chicago and Cincinnati stations, Mexico City and Havana. The last two are almost impossible on an outside aerial in the summer here. When I connected the coils to my outside aerial, my volume increased fifty per cent.

At present I am winding 300 feet of No. 26 D.S.C. on the pint-size Sealright cartons, and will see what they will do. I have a 200-foot outside aerial. It is 45 feet up at the lead-in, runs north and south 100 feet and then west to an oak tree, where it is about 90 feet high. In the winter I get wonderful results. I have also a sub aerial which I use during storms.

I am anxious to see what can be done with short-wave reception on these coils, but will have to wait until my set is built. I intend to experiment further with the coil antenna.

J. M. FRANCIS,

1507 Thirteenth St., Tuscaloosa, Alabama.  
(Simultaneously with the above, there arrived letters from other readers who had no success, and were inclined to be skeptical about the whole matter. The uncertainty about any radio circuit is, at least 90%, in its aerial and ground circuit; there is no universal prescription applicable everywhere. One man will get excellent results with a certain peculiar antenna; another none. In one

# AVIATION



-in all its phases!

Complete instruction course in three volumes. Every point of aviation efficiently and thoroughly treated. Subjects covered in these volumes—



### MODERN AIR CRAFT

700 Pages  
500 Illustrations

Contents of each chapter—  
I. Aircraft Types. II. Lighter-than-Air Craft. III. Early Airplane Designs. General Design Considerations. IV. Design and Construction of Aerofoils. V. Arrangement, Fabrication and Bracing of Airplane Wings. VI. Airplane Fuselage and Landing Gear Construction. VII. Airplane Power Plant Types and Installation. VIII. Aviation Engine Design and Construction. Air-Cooled Engines. IX. Aviation Engine Design and Construction. Water-Cooled Engines. X. Aviation Engine Auxiliaries. XI. Aircraft Propeller Construction and Action. XII. Airplane Equilibrium and Control Principles. XIII. Uncrating, Setting Up and Aligning Airplane. XIV. Inspection and Maintenance of Airplanes and Engines. XV. Details of Modern Airships and Airplanes. XVI. Seaplanes, Flying Boats, Amphibians and Other Aircraft. XVII. Some Aspects of Commercial Aviation. XVIII. Aircraft Instruments and Aerial Navigation. XIX. Standard Nomenclature for Aeronautics Report No. 240, Part I.

This book is written in simple, understandable language.

PRICE \$5.00

### AVIATION ENGINES

This treatise, written by a recognized authority on all of the practical aspects of internal combustion engine construction, maintenance, and repair, fills the need as no other book does. The matter is logically arranged; all descriptive matter is simply expressed and copiously illustrated, so that anyone can understand airplane engine operation and repair even if without previous mechanical training. This work is invaluable for anyone desiring to become an aviator or aviator mechanic.

274 PAGES

PRICE \$1.25

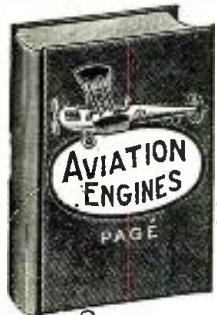

### A. B. C. OF AVIATION

This book describes the basic principles of aviation, tells how a balloon, or dirigible is made, and why it floats in the air. Describes how an airplane flies. It shows in detail the different parts of an airplane, what they are, and what they do. Describes all types of airplanes and how they differ in construction, as well as detailing the advantages and disadvantages of different types of aircraft. It includes a complete dictionary of aviation terms and clear drawings of leading airplanes.

PRICE \$1.25

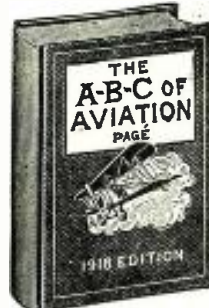

Remit by cash, stamps, check, or money order  
No C.O.D.'s

We Pay Postage On All Books

**CONSRAD COMPANY, Inc.**  
302 FIFTH AVENUE NEW YORK

## Latest GREATEST RADIO CATALOG and GUIDE

THE BARAWIK CO. has, all these years, been famous for its variety of radio supplies, which it offers at money-saving prices. Newest dynamic speakers, "B" eliminators, socket power equipment, A-C harness, fine cabinets and furniture, amplifiers, latest amateur equipment, tubes, batteries; in fact, anything you can ask for is here, ready to ship, at a saving in price. Quality merchandise, selected goods by reliable makers — just what you want — at big discounts.

### Your Savings are Tremendous

Ask any of the quarter million Barawik customers why they trade here, and they'll tell you that, quality considered, our prices can't be beat. That's something to think about! Quality comes first—new, fresh, good reliable merchandise, but the price always means a tremendous saving, nevertheless. Get our catalog and prove this to yourself. Don't spend a nickel until you see our offerings first.

You need this great radio bargain book as never before — Mail the coupon now — TODAY.



**BARAWIK CO.** 111 A Canal St., CHICAGO, U. S. A.

Mail This Coupon for FREE Bargain Book.

Name \_\_\_\_\_  
Address \_\_\_\_\_



**MAGIC**  
Taught at Home!  
New! Different! Teaches you Big Tricks, Illustrations, Stage Effects, "Patter" and the Principles of Magic. Learn at home. Only \$250 to \$400 a month. Write today for big free Magic Book. **TARRELL SYSTEM, INC.**  
1926 S. University Ave., Studio 10-08 Chicago, Illinois

Insure your copy reaching you each month. Subscribe to RADIO NEWS—\$2.50 a year. Experimenter Publishing Co., 230 Fifth Ave., N. Y. C.

Please say you saw it in RADIO NEWS

# Enjoy LOUD SPEAKER OPERATION from a CRYSTAL

NO "TUBES" - NO "B" BATTERIES - NO COSTLY "ELIMINATORS"

## WITH THE SKINDERVIKEN TRANSMITTER UNIT

Simple microphone unit provides a most effective and inexpensive way to satisfactory speaker operation. Easy to build and operate circuit.



Everybody can do this now with a Skinderviken Transmitter Unit.

The unit is fastened to the diaphragm of the speaker unit. It will act as a "microphonic relay." Every time an incoming signal actuates the diaphragm, the electrical resistance of the microphone unit will be varied correspondingly and the current from the battery, in series

with it and the loud speaker, will fluctuate accordingly. Thus the problem of securing sufficient power to actuate the loud speaker is simply and adequately solved.

The results from this very novel and simple unit will astound you.

The expense of this hook-up is trifling compared to the elaborate tube circuits that give no greater actuation of the speaker.

Besides this there are many other valuable uses in Radio Circuits for this marvelous little unit. Every builder of Radio sets should have a few on hand.

### LISTENING THROUGH WALLS

This Unit makes a highly sensitive detectaphone, the real thing—you listen through walls with ease. Plenty of fun and real detective work too.

### CONDUCTING SOUND THROUGH WATER

Make yourself a miniature submarine signaling apparatus like those used during the war. Simple circuit with this microphone unit gives splendid results.

### 12-PAGE INSTRUCTION BOOKLET

containing suggestions and diagrams for innumerable uses, furnished with each unit.

### P. G. MICROPHONE TRANSFORMER



A Modulation Transformer specially designed for use with the Skinderviken Transmitter Unit. Has many other uses. Primary resistance, 1/2 ohm; secondary, 55 ohms. **\$2**

### FOR SALE AT LEADING DEALERS

Or Order Direct, Using Coupon Below

## SEND NO MONEY

When the postman delivers your order you pay him for whatever you have ordered, plus a few cents postage.

PRESS GUILD, INC. R.N.-11-28  
16-18-R—East 30th St., New York, N. Y.

Please mail me at once as many of the following items as I have indicated.

...Skinderviken Transmitter Units at 95c. for 1; \$1.75 for 2; \$2.50 for 3; \$3.20 for 4.

...P. G. Microphone Transformers at \$2.  
When delivered I will pay the postman the cost of the items specified plus postage.

Name .....

Address .....

City.....State.....

place a listener with two tubes will get Australia and England; in another it cannot be done with the best ten-tube hook-up. These are matters still in the realm of experiment.—EDITOR.)

### A SMALL TUBE GETS RESULTS

Editor, RADIO NEWS:

I tried out a small edition of Mr. Loveless' aerial. I simply wound a hard-rubber tube 3 inches in diameter and 7 inches long full of loop-aerial wire, and another tube a little smaller full of the same, and put it on my 5-tube set for an experiment.

It brought in local stations 100% better, with slight loss of volume and a change of about 7 points lower on the left-hand dial. When I tuned for DX, I brought in WSM, which I couldn't get on my regular aerial, but threw the left dial so far off (about 15 points above 45 on the dial, and from 7 to 10 points below this) that I didn't like it. So I just hooked both leads to the "Aer" post and found it to work much better on all stations than my outside aerial. With this connection I brought in approximately twenty-five stations on August 11th, including some I couldn't get any other way. Then I put it on the short-wave "Junk-Box" receiver and it worked better; so I left it on. I couldn't get anything without the ground. Do you suppose an "A and B" power unit would cause such a change in the settings, since the eliminator is grounded? My groceryman is making a regulation Loveless aerial, so I'll try it out.

I am pleased with the "Junk-Box," and if I had used best-grade parts, perhaps I would get foreign stations also; but being next to an ice-cream factory probably affects DX. I get 2NE and WLW regularly; but KDKA does not come in as regularly as I thought when I built the set, and I have not had 2XAF; though I have tried hard for it.

E. C. HAVES,

324 Plymouth Ave., Buffalo, N. Y.

(Adding inductance to a tuned aerial coupler must, of course, alter dial settings, unless capacity is also reduced to make up for it. As for the power unit, its effect would depend upon the actual resistance—to ground—of the system.)

### WE SUGGEST ASBESTOS PHONES

Editor, RADIO NEWS:

I write this listening to a concert from KPAD, Phoenix, with good loud-speaker volume, while the temperature is around 102 in the shade (Sorry OM). My longest reception is WGY at 4:30 p. m. in the winter. As for night reception, all winter long I crawl out of the hay to pick up real DX. Here are verified receptions: JOAK, JOBK, Japan; JODK, Korea; 2BL, 2FC, 3LO, 4QG, 5CL, Australia. (Not verified, JOBK, Japan; 2YA, New Zealand.) All this on three tubes. From October to February, there was hardly a night I did not get JOAK and 2BL with good phone volume and loud-speaker volume that could be heard twenty feet away.

I would like to get in touch with DX fans who are using small sets and getting real DX, as I want to compare notes.

I like RADIO NEWS much better since the change in policy.

GILBERT HALE,  
Douglas, Arizona.

### PHONOGRAPH SWITCHOVER

Editor, RADIO NEWS:

I recently invested in a phonograph pick-up; one of those which, by inserting a plug in the detector socket of the set, allows you to use the audio end as an amplifier for the phonograph music.

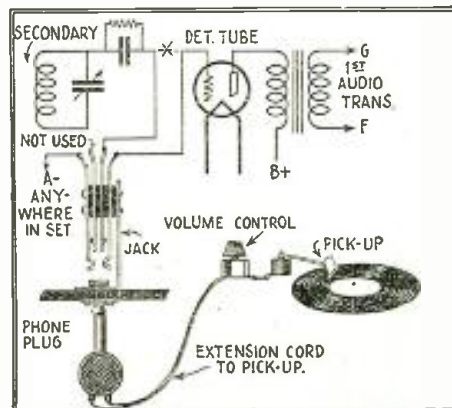

Mr. Miller's switching arrangement.

# A few cents a day brings you THOUSANDS OF DOLLARS

Sponsored by RCA, G-E and Westinghouse, this radio course qualifies you for big earnings and SUCCESS.

WIDE-AWAKE men—here is your golden opportunity. A few cents a day, real ambition to succeed, and you can increase your earning power by hundreds of dollars each year—many thousands during your active business career.

The Radio Institute of America, conducted by RCA and sponsored by General Electric and Westinghouse, offers you at low cost the training you need for success in radio.

Nothing so clear, comprehensive and up-to-date, nothing so generous in apparatus furnished has ever before been offered in radio training by any organization.

This is basically the same course that has enabled our thousands of graduates to advance to positions of importance and high remuneration in the respected profession of radio. But new and revolutionary changes make the instruction clearer and easier, permitting faster progress—and the course now embraces television, airplane radio equipment and photoradiograms.

Furthermore you can study at home—when you please and as long as you please. Your rate of progress is limited only by your own ability.

Here is a coupon that is well worth mailing. It brings you—free—an interesting illustrated booklet that shows the tremendous opportunities in the radio industry and outlines the Radio Institute of America's course of home study.

If you are really looking for a future—if you are really out for Success—mail the coupon now.

RADIO INSTITUTE  
OF AMERICA  
Dept. A-11 326 Broadway  
New York, N. Y.



## RADIO INSTITUTE OF AMERICA

Dept. A-11 326 Broadway  
New York City

Please send me your new booklet with full information about your Home Study Course of Radio Instruction.

Name .....

Address .....

City.....

Please say you saw it in RADIO NEWS

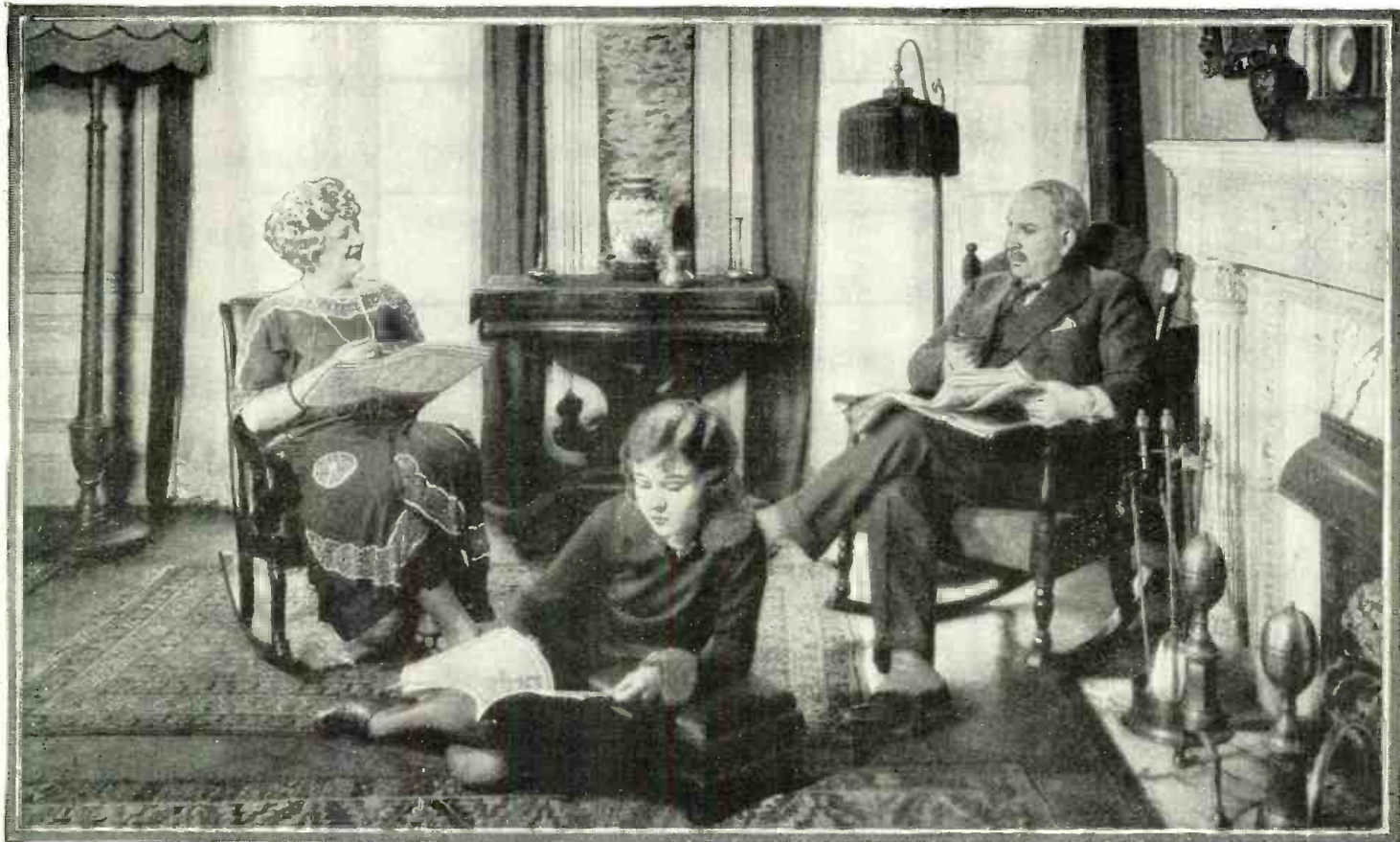

## *I Make Sure That My Entire Family Reads "YOUR BODY"---There's a Reason*

"INVARIABLY, every time I bring home the new issue of **YOUR BODY**, my daughter makes a rush to capture it. I don't stand a chance of getting it back until she has digested its entire contents. Of course I have to be reasonable. I realize that, much as I want to read it, the contents of **YOUR BODY** is of great value in teaching her the real truths of life. I know that each issue is practically an endless source of information on sex, prevention and care of diseases, the senses and the normal functions of nature as related to our bodies. All of this worth-while knowledge is of great importance in forming a basically firm character in adolescent children. That is the reason I willingly share my newspaper with my wife and wait patiently until Madeline, having read every page, grudgingly hands it back. However, in the future, I have a little scheme that will make it possible for both of us to read **YOUR BODY** at the same time. I am going to buy two copies; then I won't have to wait."

\* \* \* \*

This is the story that just one of our readers tells. We know that there are many more homes throughout the country where the same condition prevails. Our readers have found a world of valuable knowledge in each page of **YOUR**

**BODY**. They know that it is a medium devoted to the welfare of the human body and that it is to their advantage to read carefully every page. Sex, psychology, treatment of all maladies, the senses, our instincts, all are fully explained in the plainest of untechnical language. In **YOUR BODY** there is a section for every member of the family, mother, father, brother and sister. Go to the newsstand today and get your copy of this valuable magazine. Over 112 pages—fully illustrated—large magazine size.



### CONTENTS

#### FALL ISSUE

Decoding the Sex Question  
 Evolution of Our Footgear  
 Hermaphroditism  
 Why the Doctor Examines You from Head to Foot  
 Wonders of Biology  
 Menopause or Change of Life  
 The Art of Living  
 Sex Education  
 Chemistry of Our Digestion  
 Twilight Sleep  
 The Art of Healing at the Dawn of History  
 Before the Baby Comes  
 Whooping Cough  
 Psychoanalysis  
 Etc., etc.

50c. per copy

AT ALL NEWSSTANDS OR WRITE DIRECT

**EXPERIMENTER PUBLISHING COMPANY, INC. • 230 FIFTH AVENUE, NEW YORK, N. Y.**

*Please say you saw it in RADIO NEWS*

# LYNCH TELEVISION Amplifier Kit



WITH this precision-built kit you can assemble at minimum trouble and expense an efficient amplifier for securing quality reproduction in your television reception apparatus.

The audio amplifier is an extremely important part of television receivers. Where the signal to be received contains frequencies of from 18 to 20,000 cycles, the audio amplifier must be able to amplify all frequencies within these limits. Such an amplifier is available at your dealer in the Lynch resistance coupled amplifier kit.

Your dealer has a Lynch precision-built resistor for every resistance need. Send for free book.

**ARTHUR H. LYNCH, INC.**  
General Motors Building  
1775 Broadway, at 57th Street  
New York, N. Y.



## HOTEL LAFAYETTE

ATLANTIC CITY, N. J.

A new and beautifully furnished fire-proof hotel situated on South North Carolina Ave., in the Boardwalk block near the Steel Pier. Where personal service, homelike surroundings and superior food abound.

Carefully selected clientele and friendly prices. Write for Booklet D.

Arthur O. Franklin, Everett L. Cope, Proprietors

## RADIO SETS at LOWEST PRICES

Every farm, every home, every man and woman needs radio this year to follow elections, markets, big national events, football, sports, music, etc. Barawik's Big Radio Guide tells you the best sets, methods and supplies to use and how to use them for best results at lowest cost. Thousands of clear illustrations and latest valuable information, furnished free. Just send for Barawik's Big Radio Guide, the guide to radio and real radio enjoyment. You can get what you want here at biggest savings. Write today for free copy.

**BARAWIK CO.** 111D Canal Sta., CHICAGO, U.S.A.  
Mail this Coupon for Free Radio Guide.

Name.....  
Address.....



My set having only the ordinary two-stage amplifier using 201-A tubes, did not give me enough volume.

After a little figuring and experimenting I came across a way in which the detector tube could be used along with the audio tubes, making in all a three-stage amplifier; and that without having to remove the detector tube every time you want to use your pick-up. The result is all the volume you need.

The only apparatus you need for changing over your set is a double-circuit jack. (which you probably have lying around among some old junk), two phone tips, a phone plug and also a few pieces of rubber-covered wire for connections.

Remove the two connections that are soldered to the positive filament and plate prongs in the socket plug and attach phone tips to each, so that the terminals can then be placed in phone plug, which in turn can be placed in the jack whenever the pick-up is to be used.

The diagram explains the way in which I connected the jack in the circuit. By studying the latter closely you will see the way it functions.

J. G. MILLER,  
310 Rielle Avenue, Verdun, Que., Canada.

### A PROUD CONSTRUCTOR

Editor, RADIO NEWS:

I received my copy of the September issue and was surprised to see the Strobodyne dressed up in a new suit of clothes. I am the proud possessor of an original Strobodyne, which I constructed last fall, and with it I have received coast-to-coast under favorable weather conditions with tremendous volume. I deviated a little from the original design by incorporating one stage of resistance coupling in the first stage audio and push-pull in the last. I have tried out many circuits, but none so far has surpassed the Strobodyne in performance. I am anxious, therefore, to try out the new circuit to see if it is actually better. Please send blueprint No. 63, for which accept my thanks in advance.

JOHN C. A. CONSOER,  
1076 So. Lee Street, Des Plaines, Illinois.

### UNSUITED TO OTHER WAVES

Editor, RADIO NEWS:

I thank you for your reply to my letter, though you misunderstood the query. I have now as fine a Strobodyne as anyone could wish, using S-M plug-in coils rewound to suit. I have no trouble in getting KDKA and CKGW on twelve inches of antenna, right now in this hot weather; but what I wish to get information on is this:

What may I expect from 18 to 200 meters and from 550 to 3000 meters with coils to cover these bands? I have started a screen-grid Strobodyne. Will you please send blueprints Nos. 62 and 63 and oblige.

J. RASMUSSEN,  
649 Spaulding Ave., Chicago, Illinois.

(The American Strobodyne is not designed with a view to obtaining such a wide range, and while coils might be obtained to cover the European broadcast bands, it is not recommended with so delicately-balanced a receiver. As for the short-wave broadcasts, the simplest remedy is to use a one- or two-tube short-wave tuning unit, such as have been described in recent issues of RADIO NEWS, and plug into or connect by switch to the receiver's audio amplifier. This involves fewer complications than the attempt to use the intermediate amplifier of the superheterodyne.—EDITOR.)

### REFORMING A TIN HORN

Editor, RADIO NEWS:

I believe I can go Mr. Coleman several better in regards to treating a "tinny" horn. One of my first really good speakers (three years ago) was an old-fashioned "flower" horn and tone arm from a Victrola. I removed the entire horn and bracket from the cabinet and mounted it on the edge of an oak block 6 x 6 x 2 inches, which made a very good base. I then melted two cakes of paraffin, into which I dumped about two tablespoonfuls of salt and one-third of a cup of vinegar; and painted many coats of this preparation, while very hot, on the inside of the horn proper. After allowing it to dry for several days, I painted this with bronze paints of different colors, to represent a large morning glory. Use your own taste for colors and design. This horn, after being so treated, is the equal, if not superior to, an all-wood horn. This mixture is very hard when dry and will stand very high temperatures without melting or becoming greasy.

My latest speaker is a coiled up 12-foot exponential horn with a Baldwin concert unit, which makes a very pleasing home speaker if coupled to a good A.F. amplifier. I am using a 5-tube set with one screen-grid R.F. stage, regenerative detector

**New!**  
**A Speaker Extension Cord that Lies Flat on the Floor Under the Rug!**

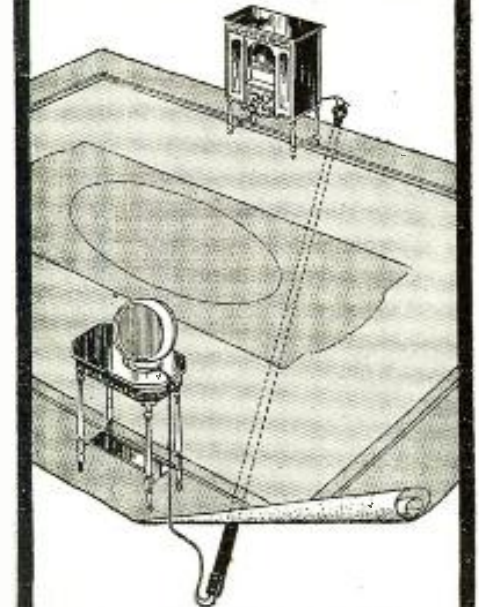

Put your set and loudspeaker anywhere. Place them as far apart as you wish. Then connect them with the wonderful Belden Extension Floor Cord. It lies flat under the rug. Out of the way—no wiring—no fuss. Get one at your dealer, now!



**Belden Mfg. Company**  
2314-A S. Western Avenue Chicago



Transmission of Photo's by Radio

TRANSMISSION OF PHOTOGRAPHS BY RADIO—Various methods have been devised and are now in use for the transmission of photographs by radio. Among these may be mentioned the systems of Belin (q.v.), Baird, and Jenkins. The principles underlying the Jenkins system are explained under the heading of Television. Using the system developed by Capt. R. H. Ranger, photographs were transmitted by radio from Honolulu to New York, a distance of 5,136 miles. Recently commercial picture transmission service has been inaugurated between New York and London using the Ranger apparatus. Two distinct methods have been applied for analyzing the picture in the process of trans-

the electron flow constitutes a discharged circuit, so that the grid becomes less negative. The first amplifying tube is a direct current potential amplifier, and is resistance coupled. The grid and plate connections of the amplifier are connected across a condenser which becomes discharged with the fall in the grid to plate resistance of the valve brought about by the grid potential fluctuations. A charging circuit is connected to the condenser and is controlled by a valve, the grid circuit of which operates by variations of the potential across the condenser. The charging current is fed through the plate circuit of this valve, in which a relay is connected, which working through other mechanical relays in

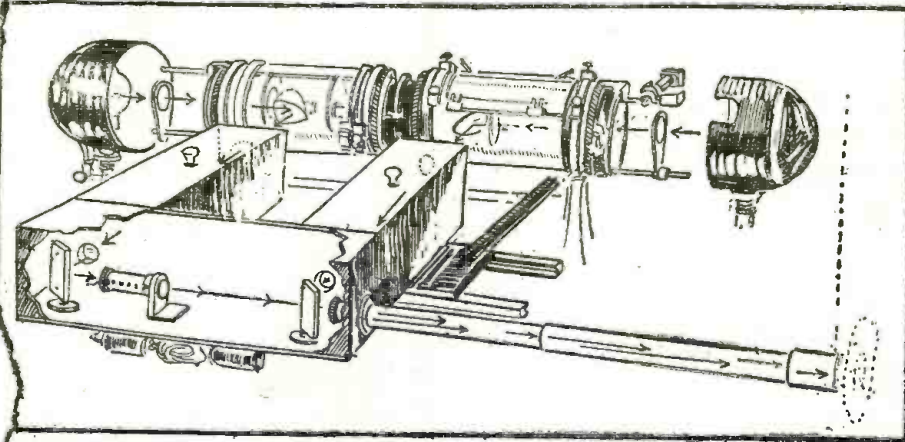

A pencil of light traverses the picture which is attached to the glass drums and is analyzed by a slow rotating action as well as a backwards and forwards movement of the carrier.

mission. One arrangement consists of producing an image as a non-conducting deposit upon a metal foil which is traversed by a stylus, while the other method makes use of an opaque image deposited upon a transparent film which is traversed by a beam of light, the light interruptions being recorded by a light sensitive cell. The Ranger system makes use of this latter method. The image is photographed and recorded upon a celluloid disc.

cascades, controls the radio transmitter. Wave trains from the transmitting station after detection and amplification, are applied to the picture recorder. The recording mechanism, in order that it may be sensitive to exceedingly small currents, comprises, a small moving coil, in a magnetic field created by three electromagnets. The coil of wire, in moving in the field, as the received fluctuations

(112A), one stage of straight transformer A.F. (112A), and a last stage of push-pull with two 171A tubes and 180 volts on plate.

Will some of the fans send in data on their experiences with airplane cloth speakers? I am just getting material to build my first.

M. A. PORTER,  
1616 Mohawk St., Chicago, Ill.

FILAMENT INPUT

Editor, RADIO NEWS:

I note some records reported by set builders claiming to use new hook-ups with 15-inch to 15-foot aerials. If they will take the ground wire off, they won't get these results; might just as well use no aerial at all. If either "A—" or "A+" or "B—" or "B+" is grounded, on turning the filament up a signal will enter the receiver via ground through the filament of the R.F. tubes, to the plate. I have cut out all grids of R.F. tubes, put ground on "A—" and received stations to either coast, using only a straight set-to-ground wire. I also find this can be done using a power unit; a signal comes in via the "A" unit, filament to plate, etc.

If you want a real test on these remarkable receiving sets, disconnect both aerial and ground; use the old-fashioned "A" and "B" batteries; then see how much aerial it requires to get enough power for loud-speaker volume.

O. R. AIKMAN,  
Salem, Illinois.

(Some of Mr. Aikman's fellow-experimenters who haven't been able to get the coast on a 150-foot aerial will probably want to know how he does it. How many readers have been able to receive on the power-unit line alone as an aerial?—EDITOR.)

A DOUBLE-GROUND SYSTEM IN EUROPE

Editor, RADIO NEWS:

I read with interest the article by Dr. W. Griffith, as I have been using his hook-up for the last fourteen months. I inherited a V-shaped aerial, about 120 feet long and 40 feet high and, as it gave excellent results, I had no reason to inspect it any closer. One day I noticed by chance that the other end was carefully grounded. First I wondered how my set could have worked at all, but soon I realized that I was using a big loop.

My set is a power Supradyne, which is wired for operation with loop and aperiodic aerial. It reaches easily the noise level. As soon as the idea of the loop had struck me, I changed the connections over to the loop terminals, tuned it as such, and found that the set worked about equally well.

This aerial gives good results with wavelengths from 15 to 3,000 meters. At night, a 3-tube, short-wave set fills the house with good music from 2XAD right across the Atlantic Ocean.

I wish to call the attention to another very important fact. For wavelengths of the American broadcast band, the noise level can be lowered considerably by connecting the ground wire only to one of the terminals marked "loop." It has to be tried out, which one of the two gives more volume. The volume decreases but, if the set is powerful enough to be brought up to the same volume, it will be found that the noise level has been lowered considerably, and that stations can be reached which were well below the noise level before.

If the lead-in wire is eliminated, or if the loop is closed, all reception is cut out. This shows that, even with the ground-connection alone, the whole loop is at work and not only the ground part, as might be supposed.

For long and very short waves, I always have to connect both wires. The directional effect must be very small, as America is coming in at right angles almost.

OTTO BAUMANN,  
3 Travessa do Azeite de Oliveira,  
Barreiro, Portugal.

IN THE WINTER, THEY DON'T FISH

Editor, RADIO NEWS:

I can term myself a listener, for about three months out of the year—during the dry season; for reception is quite impossible, on broadcast waves, during the wet season. We on the Canal Zone find it pretty nice to "rear back" in our chairs and get the baseball scores almost as fast as they are made. And it's also nice to be able to drag in a concert from England or Holland (short-wave, of course), even though there is a little squeal or motor noise "back of it." It's better than going to a theater and sitting in front of a gum-smacking, title-reading, so-called "listener," who explains aloud all the scenes of the thriller. We're all anxious to hear new ideas to improve broadcast reception, but we don't want the blah of a few high-hat listeners who haven't even an amateur op's license. In spite of the powerful "locals"

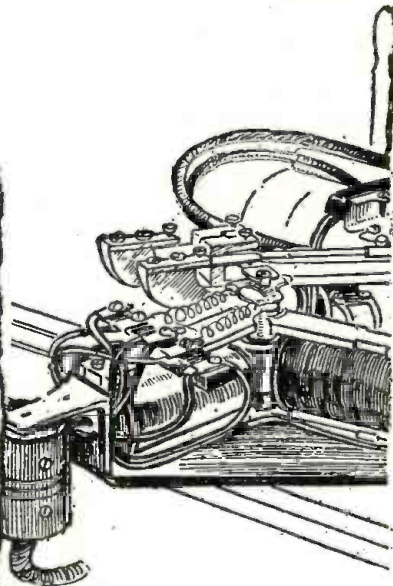

recording mechanism of the receiver. The stylus which a moving coil

is applied through its windings, vibrates a stylus while travelling across the surface of the paper. The stylus traverses the paper in perfect synchrony with the carriage of the transmitter, the paper being lifted

S. Gernsback's Radio Encyclopedia

A facsimile of a portion of a page from S. Gernsback's Radio Encyclopedia is reproduced herewith. A glance at the thorough manner in which each item is treated cannot fail to instill a true appreciation of the value of the remarkable book. S. Gernsback's Radio Encyclopedia is the first ever published. It is not a dictionary. It covers every possible phase of radio. Every circuit, each piece of apparatus, all the leading characters of the industry, broadcasting, receiving, television, telephoto, everything connected even in the slightest way with the growth of radio or its kindred sciences, is most authentically explained. There are over 1930 separate definitions, 549 illustrations, a complete cross index, and many other special features. S. Gernsback's Radio Encyclopedia comes in two beautiful bindings, large 9 x 12 in. size.

Cut here COUPON Cut here

- Beautiful Limp Suede Edition (de luxe) \$5.00
□ Keratol-Leather Stiff Binding..... \$2.00

Write your name and address in the margin below, mark which binding you prefer, and the book will be sent to you C. O. D. plus postage.

S. GERNSBACK
230 FIFTH AVE. NEW YORK, N. Y.



**Single dial control**

# 7 TUBE SUPERPHONIC RADIO

All parts mounted

**Only \$16.95**

**COAST TO COAST RECEPTION**

**Superphonic 7 is a world beater! An exceptionally high grade receiver that is amazing the Radio World. Latest 7 tube tuned radio frequency circuit, using 4 radio frequency amplifiers, detector and 2 stages of audio. Power tube can be used in last audio stage. Extremely selective, marvelous sensitivity. Single drum dial control. Straight line wave length condensers permit accurate, equally spaced tuning over entire wave band. All sockets spring cushioned to eliminate microphonic noises. Bakelite subpanel (3 3/4" deep) insures minimum dielectric losses. Clear and realistic reception guaranteed. An exceptionally beautiful, walnut finish, metal front panel 7" x 18". Complete chassis. No extra parts to be added. All parts mounted ready to wire. No special tools needed. All hook-up wire and colored battery cable included. Value \$60.00; our price \$16.95.**

**TESTED AND APPROVED**  
Severe laboratory tests have proved the remarkable efficiency of this set. Owners everywhere are sending us letters praising its wonderful receptive qualities.

**SIMPLE WIRING DIRECTIONS**  
Very easy to wire this set with the instruction we furnish. Just connect a few wires. All you have to do is to follow numbers. Simple as adding 2 and 2. Can be wired in a few minutes by anyone. No radio knowledge needed. Make money by wiring these sets in your spare time and selling them to your friends.

**NO RADIO KNOWLEDGE NEEDED!**

**SEND NO MONEY**

Just write your name and address on a post card and ask us to send you this wonderful set. We ship right away. Upon arrival pay only \$16.95 with a small delivery charge. (Foreign countries send \$19.50 with order. We pay shipping charges.)

**RADIO EQUIPMENT CO.**  
549 S. Wells St., Dept. 12-1, CHICAGO, ILL.

(b-r-o-a-d, powerful spark and I.C.W.), we Zonites get a good deal of enjoyment out of the little black boxes.

Broadcast stations in the States are as thick as Lizzies. It seems to me that it would be better to limit the stations to one to each state; Texas might need two. In that way, I think, we will gain a great deal and lose these "fox-in-a-hencoop" programs that have been reported here in Hague, S. D.

C. MAYNE ROY,  
Hq. Battery, Ft. Sherman, Canal Zone.

(A simple solution, so far as the Canal Zone is concerned, and where all broadcasts are DX. Whether it will meet conditions in the U. S. A., let the Radio Commission bear witness. However, the increasing number of short-wave broadcast stations is bringing comfort to the dwellers in distant outposts, not only of the United States, but of all the countries of Europe.)

**—AS THE LADY SAID, WHEN SHE KISSED THE COW**

Editor, RADIO NEWS:

I can't see why people spend so much money to buy sets or make them; this also includes speakers. I know many who have \$30 speakers, and still their results are not so good. I think I have the cheapest speaker in the world and the most perfect for that price. It is a unit with a 10-cent megaphone over it and cost me \$2.69. My sets are a five-tube T. R. F. set and a six-tube resistance-coupled set known the world over for its selectivity. Many of my friends who have expensive sets and speakers, both built-in and separate, have to admit that my sets sound 100% better than theirs. Both give me very good results both on low waves and high waves, and both cost me less than \$25 complete. I use 135 volts "B" power on them, with a power tube in the last stage, and either a 200 or 201A detector. An output transformer helps to clarify.

SAMUEL DONNER,  
309 Floyd St., Brooklyn, N. Y.

**WHEN A GROUND'S OVERHEAD**

Editor, RADIO NEWS:

The generally-accepted doctrine that a water pipe makes the most perfect ground was abruptly shattered, to my mind, when a peculiar constant hum that has been present in my set for the past five years instantly ceased on my changing to a deep earth ground. This hum was of variable intensity, apparently coordinated with electrical conditions in the air, and attended long- and short-wave code as well as broadcast reception.

My diagnosis is that there was a six-foot range boiler in the water-pipe circuit, and this was in metallic connection with a steel standpipe 165 feet above the set. This in some way brought about a conflict or interference between the radio waves. In any event, divorcing the combination ended the trouble, and my 150-foot aerial seemed to appreciate the relief.

C. E. BUZZELL,  
Leaf River, Ill.

(It is possible that a pipe line may contain an insulating ring—meter, etc.—between set and ground; and an extremely long antenna system subject to power-line pick-up resulted. Many of our readers may be able to take a tip from Mr. Buzzell's experience.—EDITOR.)

**WHERE THE DX IS**

Editor, RADIO NEWS:

I received about 175 letters from DX fans (most of whom enclosed a stamp) about my recent communication to RADIO NEWS, and have answered them all. I like to correspond with those who are interested in reception of distant stations. These schedules may be of interest to listeners: all hours given are Eastern Standard Time.

CYJ, Mexico City, 410 meters, 1,000 watts: 9 to 10:30 p. m., except Sundays.

PWX, Havana, Cuba, 400 meters, 500 watts: 8 to 11 p. m., every night.

6KW, Tuinucu, Cuba, 365 meters, 100 watts: 11 to 12:30 p. m., Fridays, Saturdays and Sundays. This station has very good carrying power, and reception from it is very good.

WKAQ, San Juan, Porto Rico, 322 meters, 500 watts: 9 to 11 p. m. Wednesday, 10:30 to 11:30 p. m. Fridays.

HHK, Port au Prince, Haiti, 357 meters, 1,000 watts: 8 to 9 p. m. Friday, 6:45 to 7:15 p. m. Saturdays.

KGBU, Ketchikan, Alaska, 400 meters, 500 watts: 1 to 3 a. m. Tuesdays, Thursdays and Sundays.

OAX, Lima, Peru, 380 meters, 6,000 watts: 11 to 12 p. m. Mondays and Wednesdays, 9 to 11 p. m. Tuesdays and Thursdays.

SMZK, Falun, Sweden, 357 meters (will probably be changed to 333 or 315 meters) 2,000 watts,

## A Small Part with a BIG JOB

AMPERITES take little space, but they control the very life blood of your receiver by automatically regulating the tube filaments.

It pays to use AMPERITE—the only self-adjusting resistance for "A" current. Maintains filament temperature at proper voltage despite variations in supply. Essential with eliminators. Entirely unlike fixed resistors. Instantly interchangeable. Banishes hand-rheostats. Beautifies panel layout. Saves wiring. A type for every tube—battery or A. C. \$1.10 with mounting (in U.S. A.), at all dealers.

**Radiall Company**  
50 FRANKLIN ST., NEW YORK

FREE "Amperite Blue Book" of new circuits and how to build date. Write Dept. R. N. 11

# AMPERITE

The "SELF-ADJUSTING" Rheostat

# Radio HEADQUARTERS

The newest radio wrinkles—A-C, grid tube, short wave, television, dynamic speakers, newest tubes and circuits—anything and everything in radio—are now ready for you at Barawik's. With elections, football, National broadcasting, Roxy and other big doings filling the air, thousands of newcomers will take to radio this year as never before. Business will be good—Set builders will make money. You can clean up big by buying from Barawik—the oldest, biggest, most reliable radio house in the world. Let us prove it. Send now for the Big Book—all ready for you—free. Get the latest radio information and lowest prices.

**BARAWIK CO.**  
111 B CANAL ST., CHICAGO, U.S.A.

This Big Book Sent to You Free

Name.....  
Address.....  
City.....

**AUDIO TRANSFORMERS—97c**  
Think of it! A \$4.00 audio transformer—a genuine Illinois "all frequency" unit of the finest musical capability, offered direct from the factory for only 97c each. A real bargain opportunity. Thousands have bought them. Sold with positive guarantee of satisfaction or money back. Supplied in ratios of 1 1/2 to 1, 3 to 1, and 5 to 1. Order now. ILLINOIS TRANSFORMER CO., Dept. 108 223 W. Elm St. Chicago, Ill.

**6-TUBE RADIO COMPLETE**  
\$34.75 to \$66.66  
Licensed R.C.A. Circuits. Shielded. One Dial  
Write for catalog. Big discounts to agents  
Consumers Radio Co., Dep. 151, 4721 Lincoln Av. Chicago

# YAXLEY

UNPROVED RADIO PRODUCTS

## Junior Rheostat



Small in size, but a master instrument. Ask your dealer to show you the exceedingly fine adjustment and velvet smooth action. Diameter, 1 1/2 in.

- Up to 400 ohms.....\$0.75
- 1,000 and 2,000 ohms.....1.00
- Potentiometers.....extra .25
- Self-attaching, positive-acting switches for Junior Rheostats......40

## FILAMENT AND GRID TYPE RESISTANCE UNITS

Here is where you need absolute dependability and you get it with Yaxley Resistance Units. Run true to rating. Convenient screw eye and soldering lug terminals for easy mounting. One to 3,000 ohms, 15c. to 40c.

**YAXLEY MFG. CO.**  
Dept. N 9 So. Clinton St., Chicago, Ill.

## Wholesale Prices

Tremendous stock and sales volume, with rapid turn-over to the thousands of radio dealers we serve enables us to make you worthwhile savings at lowest wholesale prices. Write for latest, new illustrated Catalog "B-1"

**Allied Radio CORPORATION**  
711 W. LAKE STREET, CHICAGO

Insure your copy reaching you each month. Subscribe to RADIO NEWS—\$2.50 a year. Experimenter Publishing Co., 230 Fifth Ave., N. Y. C.

# New!

EDITION

## TELEVISION

*A Magazine for the Experimenting Fan*

"TELEVISION" is a magazine pledged to further the art of the infant industry for which it is named, and to supply the "fans" with the latest information and developments in this fast-growing field. Television, as a science, occupies the same position today as radio did ten years ago. Like the radio fans of years back, enthusiasts of this new field have had to

fight for whatever meager knowledge they have been able to obtain. This magazine, then, comes as manna to the information-hungry fan. It is our purpose to keep these enthusiasts constantly informed, through "TELEVISION," of each new development. The second issue of "TELEVISION" is now on the newsstands.

You will find below a partial

list of its interesting contents

In the Television field there are all of the thrills that the radio fan knows so well. Get on the band wagon with your fellow enthusiasts. Be the first in your neighborhood to own a television set. Obtain a copy of "TELEVISION"; it will show you how to build a real Television receiver.

The first Television magazine was published by the EXPERIMENTER PUBLISHING COMPANY about a year ago. Over 50,000 copies of this magazine, "TELEVISION," have since been sold. This, alone, is sure proof of the popularity of this interesting new art.

### Partial List of Contents

New Jenkins Radio Movies  
New Belin Photo Transmitter  
Vacuum Cameras to Speed Up Television  
Infra-Red "Eye" Sees at Night  
Valensi Television  
Connection of Photo-Electric Cell

Practical Demonstrations Scheduled for Station WRNY  
Campbell Swinton Television System  
Quartz Crystals Synchronize Television Sets  
Baird Optical Lever Increases Speed  
Recording Pictures with Air Jet  
How to Build a Radio Photo Recorder

and many other articles of equal interest

AT ALL NEWSSTANDS

THE **25c** COPY

OR WRITE DIRECT

EXPERIMENTER PUBLISHING CO., INC., 230 Fifth Ave., New York, N. Y.

EXPERIMENTER PUBLISHING COMPANY, INC.  
230 Fifth Avenue, New York City, N. Y.

Gentlemen: Please forward to me a copy of TELEVISION. Enclosed find 25 cents.

Name.....

Address..... City..... State.....

11:30 to 3:30 p. m. daily. There is a chain of 28 stations on the Swedish national programs.  
"Ravag," Vienna, Austria, 517 meters, 7,000 watts: 3 to 7 p. m. daily.  
2LO, London, England, 361 meters, 5,000 watts: 4:15 to 6 p. m. daily except Sundays; then it is from 9:30 a. m. to 4:30 p. m.  
5CL, Adelaide, South Australia, 409 meters, 5,000 watts: 3:45 a. m. to 2:55 p. m. daily.  
5SC, Glasgow, Scotland, 405 meters, 1,500 watts: 5 a. m. to 5 p. m. daily except Sundays; then 9:30 a. m. to 4:30 p. m.  
5SW, Chelmsford, England, 24 meters, 15,000 watts: 7:30 to 8:30 a. m., 3 to 4 and 4:15 to 7 p. m. daily except Saturdays and Sundays.  
JOCK, Nagoya, Japan, 370 meters, 10,000 watts: 6:45 p. m. to 8 a. m. daily except Sundays; then 7:30 p. m. to 2:10 a. m.  
1YA, Auckland, New Zealand, 333 meters, 500 watts: 10 a. m. to noon, except Sundays; then 9 to 11:30 a. m.  
MTI, Budapest, Hungary, 555 meters, 20,000 watts, 10 a. m. to 3 p. m. daily. All these stations are of very good carrying power and are receivable in the United States.

I am using an NR7 Freed-Eisemann with a "master oscillator" of my own design, with 280 volts of "B" and 80 of "C": a three-stage Magnavox amplifier; a 500-foot aerial 62 feet high, and 400 square feet of grounding surface. In conjunction with this, I have a three-tube short-wave set of my own design. I may say in conclusion that I have received from thirty-nine countries on wavelengths between 5 and 700 meters. I have worked about four months on the master oscillator, which can be plugged into any set, and I have it working now on three different sets. I am always willing to help a DX "ham" who runs up against something that puzzles him.

CHARLES J. ANGSTADT,  
420 Pennsylvania Avenue, Bernharts, Pennsylvania.

### FOR EXCHANGE—OR, WHAT HAVE YOU

Editor, RADIO NEWS:  
I am a set builder in my community and I do a lot of experimenting on all kinds of sets, especially the smaller sets such as the short-wave, reflex and different types of crystal hook-ups with amplifiers. I have built an Interflex and I will say that it certainly can deliver the goods. I have added one stage of tuned radio frequency ahead of the detector, which makes the set more sensitive. I have also built a neutrodyne which will get almost any high-powered station in the U. S. on any good winter night.

I would like to correspond with radio experimenters and set builders in other countries, as well as in the United States, to exchange hook-ups and ideas on set building.

GEORGE MAKUH,  
2012 Brainard Ave., Cleveland, Ohio.

## 40 Non-Technical Radio Articles

every month for the beginner, the layman and those who like radio from the non-technical side.

SCIENCE AND INVENTION, which can be bought at any newsstand, contains the largest and most interesting section of radio articles of any non-radio magazine in existence.

Plenty of "How to Make It" radio articles and plenty of simplified hook-ups for the layman and experimenter. The radio section of SCIENCE AND INVENTION is so good that many RADIO NEWS readers buy it solely for this feature.

Radio Articles Appearing in November Science and Invention Magazine

HOW TO BUILD THE "S. & I." TELEVISION RECEIVER

PLANE BROADCASTS RADIO PHOTOS  
MID-OCEAN RADIOPHONE  
A TRIPLE DYNAMIC SPEAKER  
AN ALL-ELECTRIC RECEIVER  
NEW RADIO DEVICES  
RADIO ORACLE  
RADIO WRINKLES  
LATEST PATENTS

# EXCELLO Radio Consoles

Combination Phono-Radio Console for all standard sets, either A.C. or D.C.



Excello Combination Phono-Radio Console Model R-44

Completely equipped: GE Elec. phonograph motor, etc., and switch from phonograph to radio. Receiver compartment is a sliding drawer 24 in. x 9 in. x 14 in. Cabinet, walnut throughout, with fancy butt walnut veneer doors.

At your Dealers, or write for complete catalog of full line.

EXCELLO PRODUCTS CORP.

4832 W. 16th St., Cicero, Ill. (Suburb of Chicago)

## I Want to Know

(Continued from page 464)

in a 199 tube. When the set is in operation, the rheostat should be turned back as far as possible without reducing the volume. If an adjustable crystal is used, adjust it until a slight hiss is heard in the headphones. The tuning is accomplished by turning the condensers C1 and C2. They should now be turned until a station is heard, and the crystal should then be readjusted for maximum volume. As explained above, the connections to the secondary of the transformer should be reversed, and the position found to give better results should be used.

If no signals are heard when the set is tried, the first place to look for trouble is in the crystal detector. The crystal must be adjusted to a sensitive point and, if no signals can be heard when it has been adjusted a number of times, place a new crystal in the receiver. The next point to look for trouble is in the batteries and the aerial and ground. Test the batteries with a voltmeter or take them to a local dealer, who will have the facilities for making these tests. Look over the aerial to make sure that it is well insulated and, if possible, try another set on it to be sure it is in good condition. Finally, if no stations can be picked up, check the connections and, if no poor contacts or mistakes are found, take the set to your radio dealer or a friend and have him look it over and test the apparatus.

The two dials should read almost alike, if not exactly so. The only other adjustment to be made is that of the filament rheostat. Turn the knob on this resistor until the signals are as loud as possible, but do not make the tube burn too brightly, since this will shorten its life considerably.

### GRID LEAKS

(2312) Mr. J. M. Johnson, Andover, Mass., writes:

(Q.) "What is a 'grid leak,' and why is it used in the grid circuit of the detector tube of my set? I should think that a resistance in the grid circuit of the tube would have a tendency to reduce the volume of the music. Will you please explain the reason for its use?"

(A.) A grid leak is a high resistor, connected between the grid terminal of a detector tube (or an amplifying tube) and some part of the filament circuit of the tube. Grid leaks are usually rated according to their resistance in megohms or in fractions of that unit; the megohm is equal to 1,000,000 ohms. One of the chief difficulties with grid leaks has been the uncertainty of their resistance.

Many kinds of grid leaks have been used; the original type consisted of pencil marks on a piece of paper between two contacts. Naturally this type of grid leak was affected by moisture in the air and changes of temperature. A more recent type is made of a piece of fibre impregnated or coated with some form of carbon, mounted in a short length of glass tubing, and fitted with metal ends, which make contacts with two spring clips. Leaks of this type are quite satisfactory, if they are air-tight so that moisture cannot enter.

The most recent type of grid leak consists of a piece of glass tubing, on the inside of which has been deposited a layer of resistant metal, which acts as the conducting medium. Another variation of this metallic type has the coating on a piece of insulating compound inside the tube. The resistance of these grid leaks is much more constant than that of other types and, by carefully watching the amount of metal deposited, the resistance values can be made much more accurate.

### Grid Leaks and Detectors

The purpose of the detector's grid leak is to assist in the control of the "grid bias" of the detector tube, and also to allow dissipation of the excess negative charges (electrons) that accumulate on the grid of the tube. Although detection can be obtained without a grid leak, by correctly biasing the detector tube, this method is not nearly as sensitive as the grid-leak method and, for this reason, has not gained much favor. (See the answer to Q. 2272, "What is Detection?" on page 1151 of RADIO NEWS for April, 1928.)

The proper value of the grid leak depends both on the type of tube employed and on the strength of signal being received. It also depends, to some extent, on the tendency of the receiver to oscillate. When very weak signals are being received, a very high-resistance leak should be used, in order to get the greatest amount of volume. However, when loud signals are being received, a rather low resistance must be used to maintain good tone quality. From this explanation, it can be seen that a compromise value must be chosen, to give good

# BENJAMIN

## Cle-Ra-Tone Radio Sockets



Specially Designed for  
A. C. Detector Tubes

Spring supported, shock absorbing. The tube-holding element "floats" on perfectly balanced springs. Reduces microphonic disturbances, tends to lengthen life of tube, and lessens the possibility of short-circuiting closely-spaced tube elements.

Y-Type, Green Top, for 5 Prong A. C. Tubes: for mounting on top of panel, \$1.00; for direct attachment to panel, 75c.

Red Top, for Standard UX Type Tubes: For mounting on top of panel, 75c.; for direct attachment to panel, 50c.

At all Radio and Electrical Dealers and Jobbers

Benjamin Electric Mfg. Co.  
120-128 S. Sangamon Street  
Chicago

New York San Francisco  
247 W. 17th St. 448 Bryant St.

## CHI-RAD

New 1929 Catalog  
FREE to Set Builders

Includes Complete Parts for

H. F. L. ISOTONE

New TYRMAN "80"

MADISON-MOORE "AC"

NATIONAL B. D. "AC"

New THORDARSON Power Amp.

Discounts for Set Builders

Chicago Radio Apparatus Co.  
415 S. Dearborn St., Dept. RN, Chicago

### Your Set Can Now Get Short Waves



Sent anywhere in the U. S. post paid upon receipt of price. Canada and Foreign, 60c additional. Money order only. Also sent C. O. D. plus postage in U. S. If \$1.00 accompanies order to insure carrying charges. In ordering be sure to name set and tubes used, such as UV199, UX199, WD11, 201A, UX226 or UY227. Price \$15.00 or \$17.50 for A. C. Sets.



### The SUBMARINER

will convert your regular set into a short-wave receiver by simply inserting a plug in place of one of the tubes. This takes but a few seconds. With "Submariner" it will enable you to tune between 20 and 65 meters.

This device operates with all sets, such as T.R.F., Neutrodyne, Super-Heterodyne and others A.C. or D.C. operated. No additional tubes, batteries, or coils required. If set operates a speaker it will do so with "Submariner" attached. Operates as a wave changer with Super-Heterodyne and as detector unit with others.

### SHORT-WAVE RECEPTION

is practical, as short waves penetrate better and there is less static. The "Submariner" waveband includes practically all powerful stations which broadcast programs. You may also listen to amateurs from all parts of the world who transmit code messages. You will have one of the most efficient short-wave receivers when the "Submariner" is attached to your set. Get a "Submariner" so you may have command of the short-wave activities as well as the broadcast band. Never before has so much in radio been offered for so little money! A new thrill awaits you! If your Dealer does not carry

### ORDER TODAY DIRECT

This device has been nationally advertised, and sold in all parts of the world for the past two years

J-M-P MANUFACTURING CO., INC.  
3401 Fond du Lac Ave. Milwaukee, Wis., U. S. A.

**LATEST RADIO GUIDE**

**NEWS to Set Builders**

Barawik offers set builders bigger bargains — bigger opportunities to make money this season. New sets, new kit ideas, all the leading parts, dynamic speakers, supplies, etc. Lowest rock-bottom prices. Bigger stocks, quicker service. Send for Big Barawik Book today — free.

**BARAWIK CO., CHICAGO, U. S. A.**

211A Canal St.

# ANOTHER ACHIEVEMENT



by **Dr. Lee De Forest**

With the same creative enthusiasm that produced the first radio vacuum tube (1906) Dr. De Forest has now developed the perfected Audion.

When you replace your tubes with DeForest Audions you will experience a new enjoyment in clarified reception.

Send today for your free copy of the interesting booklet by the "Father of Radio."

**De Forest Radio Co.**  
JERSEY CITY ~ N.J.

FOUNDED 1899

IN 12 WEEKS

## LEARN ELECTRICITY

Learn to Earn \$60 to \$200 a week!



Learn on Actual Electrical Machinery in 90 Days

Get into Electricity in 90 days. Learn by actual work in the great roaring shops of Coyne, Not a Correspondence School. All practical experience on full-size electrical machinery. Now 22,000,000 school with vast new electrical machinery. You don't need advanced education or experience. We Will Assist You To Part Time Job While Learning And Free Employment Service For Life After Graduation. Special offer for limited time—Hagis and Automotive Courses without extra charge. Act now—get big free book.

**COYNE ELECTRICAL SCHOOL**  
500 South Pauline Street  
CHICAGO, ILL.  
Dept. 88-77

### Fill In And Mail To Day

H. C. Lewis, Pres.  
Coyne Electrical School, Dept. 88-77  
500 South Pauline St., Chicago, Ill.  
Dear H. C.: Please send me free your big catalog and full particulars of your special offer.

Name \_\_\_\_\_  
Address \_\_\_\_\_  
Town \_\_\_\_\_ State \_\_\_\_\_

## SET Builders

Elections have brought back Custom Set building. Business is booming. Thousands of old-timers are cleaning up. Let Barawik show you the way to bigger profits, more sales. Send today for Barawik's Big Bargain Book—the radio man's bible.



**BARAWIK CO.** 2115 Canal St. CHICAGO, U. S. A.

quality and sufficient sensitivity. A variable grid leak may be used; but most of them are unsuitable because of their tendency to make the set noisy, and set owners usually try to avoid adding another adjustment. If the grid leak has too high a resistance, the receiver will howl and block without much provocation. The blocking is indicated by a series of popping noises either fast or slow, depending on the value of the leak and the other constants of the circuit.

If the resistance of the grid leak is too low, the distant stations will be weak, or entirely absent. It may also be found difficult to make the set regenerate and, when the regeneration point is reached, the set will suddenly drop into oscillation.

With the "hard" tubes (such as the 201A, 199, and 112A) a grid leak with a value of between 2 and 5 megohms will usually be found satisfactory, at wavelengths in the broadcast range. The gaseous tubes (of the 200A type) will also use a value within this range; while the old-style soft tube (similar to the UV-200) required a value of about 1/2-megohm. However, the best value for the grid leak in a particular receiver can only be found by experiment.

### Grid Leaks in Amplifiers

Grid leaks, or grid resistors, are used also in amplifiers of certain types. In the choke-coil and resistance-coupled amplifiers, in which the stages are coupled through transformers, the grid must be supplied with the correct bias. In order to keep the "signal" (A.F. or, sometimes, R.F.) in the correct channel, it is necessary to use an arrangement which will allow the direct-current potential of the "C" battery to be placed on the grid, but will not short-circuit the signal current. This may be accomplished by the use of either a choke coil or a resistor of the correct value. Since the latter is much simpler and cheaper, it is used more frequently.

The bias applied to the grid is determined by the value of the leak and method in which the resistor is connected to the filament circuit. If it is connected to a "C" battery, the biasing voltage depends on the potential of this battery, of course, as well as on the resistance of the grid leak. When the grid return is connected to the negative terminal of the filament circuit, the bias is derived from the "A" battery, and it is necessary to use the correct resistance in the grid leak in order to have the tube correctly biased. The latter method is often employed in the first stages of an amplifier where the grid voltage does not have to be very high.

## AMAZING STORIES

In Our November Issue:

**The World at Bay**, by B. and G. Wallis. Part I. Application of the fourth dimension, in this story, enables the travelers to make a journey to the moon and back and around the earth in an astoundingly short space of time. Our new authors have given us a carefully studied treatment of the subject of interplanetary travel, cleverly interwoven with romance and human psychology.

**The Ananias Gland**, by W. Alexander, M.D. What determines the extent of our thoroughness? It might very well be glandular action of some kind. Mr. Alexander cleverly works up an idea of extreme interest.

**The Psychophonic Nurse**, by D. H. Keller, M.D. Instead of contenting himself with the conception of new mechanical labor-saving devices—generally involved in the human scheme of life—Dr. Keller always goes further. He gives us, in a perfectly natural manner, the ultimate psychological effect of his mechanical innovations, on the human being. Though he never destroys—or even temporarily puts out of commission—his newly developed apparatus, we are glad, when we finish the story, that we are still a little ahead of the invention.

**The Eye of the Vulture**, by Walter Kately. The human eye is limited in its vision of the colors of the spectrum, just as the ear is limited in its range of sound appreciation, and it must differ drastically from that of animals, birds, insects, etc. A bird, for instance, may not see all we do; on the other hand, many things within the bird's visual range may be completely out of ours. In this story, a number of theories, novel and interesting, but seemingly founded on scientific grounds, are introduced. And Others.

## ACTS in 7 seconds

—against 30 seconds to a minute for other tubes—the Arcturus 127 A-C Detector Tube! Put an Arcturus A-C Long Life Tube in every socket for quicker action, better tone, better volume, longer life and immunity to line surge.

Complete line of Arcturus low voltage Tubes: 126H, 126, 071H, 071, 127 and 180.

Arcturus Radio Company  
255 Sherman Ave., Newark, N. J.

## ARCTURUS



Less Static  
**Sharper Tuning** Bring Your Set to Maximum Sharpness  
IN EVERY HIGH GRADE CIRCUIT TODAY

MODEL "N" VARIO-DENSER—Micrometer adjustment easily made, assures exact oscillation control. Quick, easy tuning, more volume, clearness and stability. Capacity range 1.8 to 20 micro-microfarads. Price \$1.00.



Made in 3 variable capacity ranges; price, each, \$1.50.  
**FREE** Big new up-to-date book of wiring diagrams of all leading circuits. Write today for copy.

## XL Radio Laboratories

Dept. A, 1224 Belmont Ave., Chicago, Ill.

## 1000 HOURS—of the Best Fun You Ever Had—Get Your Copy of SAM LOYD'S Tricks and Puzzles

The year's most unique book, contains 120 pages that are crammed full of all kinds of tricks, puzzles, games, conundrums, etc.

Size, 9 x 12 inches—illustrations on every page. Fun for every member of the family.

50c On All Newsstands.

EXPERIMENTER PUBLISHING CO., Inc.  
230 Fifth Avenue, New York, N. Y.

# NEW! 90 Volt Power Unit



Positively Eliminates Hums, Line Noises, etc. Greater Volume and Clarity Guaranteed **\$12.75**

Non-acid and noiseless. All detector and intermediate voltages plainly marked. Simpler to hook up than dry cells. Operates 1 to 12 tubes. If not thoroughly satisfied return after using 30 days for complete refund. Guaranteed further 2 years. For 110-120 volts A.C. 25 to 60 cycle current, 90 volts, \$12.75; 112½, \$15.25; 135, \$17.50; 157½, \$19.50; 180, \$24.00; 202½, \$26.00. Also built for D.C. current 110 and 32 volts at only \$3.00 additional, any size above. Ample stocks—same day shipments. Simply say—ship C.O.D. or write for my interesting literature, testimonials, etc.

**B. HAWLEY SMITH**  
334 Washington Ave., Danbury, Conn., U.S.A.

## Radio News Laboratories

(Continued from page 461)

vides a resistance of approximately 150,000 ohms in the plate circuit of the tube. A high value of inductance is used in the grid circuit of the succeeding tube, which gives a step-up ratio through the use of the grid inductor as an auto-transformer. The plate output of the preceding tube is coupled to the primary tap of the auto-transformer-coupled grid inductor through a capacity of such size that excellent amplification is obtained between 30 to 5,000 cycles. The iron-core inductor, plate resistor and coupling condenser are encased in an iron housing of black enameled finish, 4 inches high, with a base 3¼ x 3½ inches. Excellent quality and volume, with great amplification, was obtained when the unit was tested in a screen-grid, space-chargé A.F. amplifier.

AWARDED THE RADIO NEWS LABORATORIES CERTIFICATE OF MERIT NO. 2435.

### GRAPHITE (IN SUSPENSION)

"Aquadag," submitted by the Acheson Oil-dag Company, Port Huron, Mich., is a concentrated colloidal solution of artificial (electric-furnace) graphite in water, which has found successful use in the manufacture of resistance elements for grid-leaks and variable resistors. It has been used also



as a dry lubricant for condenser bearings and for the drawing of tungsten wire. It has been used in tube manufacture as a "Getter," as an opaque coating in the manufacture of photoelectric cells, and has been found, as well, useful in establishing positive electrical contacts, and as a conductive coating for electroplating. It has many other applications, and is suitable for uses of the manufacturer, either the above-named, or wherever conductive material of this type is needed.

AWARDED THE RADIO NEWS LABORATORIES CERTIFICATE OF MERIT NO. 2436.

### R.F. CHOKE

The R.F. choke coil shown, submitted by the Hammarlund Manufacturing Co., 424 W. 33rd Street, New York, N. Y., is of the helical-winding type. It was found to have an inductance within 10% of its rated value, 85 millihenries, when measured at 1,000 cycles. The D.C. resistance, as measured, is 2,000 ohms. The distributed capacity was found to be extremely small, in comparison with the inductance. The coil is contained in a molded black bakelite housing, 1¼ inches high, and requires a base space 1½ x 2 inches.

AWARDED THE RADIO NEWS LABORATORIES CERTIFICATE OF MERIT NO. 2437.



### SHORT-WAVE TUNING CONDENSER

The short-wave condenser (Type ML-7) shown, submitted by the same manufacturer, is a 7-plate condenser of the midline-frequency low-loss type. It has a sturdy cast-aluminum frame supporting the stator, and drilled for base-board or sub-panel mounting; two flat-head screws are provided on the front of the frame for panel mounting also. The stator plates are soldered to plate-spacing mounting brackets which, in turn, are fastened to the bakelite insulating strip.

The stator plates are provided with a spacing bar and the entire stator assembly is supported from the bottom of the frame. The rotor is of the "floating type"; which allows the removal of the shaft, and the operation of the condenser in a gang. The bearings are of the cone type, and the rotor is provided with maximum and minimum

# THE MIRACLE OF THE RADIO WORLD!

Newest Guaranteed 7-Tube 1-Dial Console Set—Worth \$200

BUY DIRECT 1929 MODEL



A BIG VALUE COMES COMPLETE

ALL ELECTRIC RADIO

30 DAYS' FREE TRIAL!

A Wonder Bargain!

Buy direct from factory—\$200 VALUE

Outperforms sets selling at 2 and 3 times our low price. Includes console shown, made of combination walnut; A. C. electric set, all tubes, built-in magnetic speaker and aerial equipment.



Only \$79.85

COMPLETE Nothing Else to Buy

Powerful Reception—Amazing Tone!

Remember—30 days free trial. You be the Judge! Worth \$200 and looks like it! Only one dial to tune—illuminated! Marvelous mellow tone. Selective and gets distance easily. The radio sensation for quality, price and performance. Mail coupon today for our big, money-saving Free Catalog, before you buy any radio or accessories!

### Battery Sets

Our low factory prices on the complete line of Diamond Electric and battery operated radios shown in catalog will amaze you!

Our New FREE Catalog—Just Published—Shows You How To SAVE HALF!

**Diamond Radio Company**  
Dept. 214 - 820 S. Clinton St., Chicago, Ill.

MAIL THIS COUPON TODAY!

Diamond Radio Company, Dept. 214  
820 S. Clinton St., Chicago, Ill.  
Please send me your Free Catalog of Diamond radios and details of your 30 Day FREE Trial offer

Name.....  
Address.....  
City.....State.....

## Newest Radio Hook - Ups — Free —

Send now for the newest radio hook-up book. Shows how easy it is to build remarkable new A.C. and D.C. receivers of longest range, greatest volume, purest, clearest tone, and super-selective. Also shows how to make short-wave receivers and adapters, how to use new screen grid tube in A.C. and D.C. circuits, how to build power amplifiers and A-B-C eliminators. Latest information on all new radio wrinkles. Send for free copy now.

KARAS ELECTRIC COMPANY  
4038L3 N. Rockwell St., Chicago, U. S. A.

Name.....  
St. and No.....  
City and State.....

**INVENTORS** who derive largest profits know and heed certain simple but vital facts before applying for Patents. Our book Patent-Sense gives those facts; sent free. Write LACEY & LACEY, 631 F St., Washington, D. C. Established 1869

# CARTER

## PARTS

FOR NEW A. C. CIRCUITS USED BY LEADING SET MANUFACTURERS



Carter Center Tapped Resistors Small, compact, rugged. Guaranteed within 3 per cent. 8 different types. 6 to 60 ohms.



Carter IMP Power Switch. Self-contained double contact, positive, for 6 volts filament or 110 volt A.C. Circuit.



Carter Adjustable Resistors. The ideal A. C. Hum adjustor for mounting on sub-panel. 6 to 20 ohms.

Write for Catalog of Complete Line  
Any dealer can supply

MEMBER RIMA  
Carter Radio Co. CHICAGO

## Wholesale Prices

Here you will find a new up-to-date stock of kits, parts, accessories and sets—everything you want in radio. Write for catalog "B-1" quoting special dealer's wholesale prices.

**Allied Radio CORPORATION**  
711 W. LAKE STREET, CHICAGO

## FREE RADIO CATALOG

Since the dawn of Radio, Barawik has been known the world over as headquarters for radio set builders and fans. Here, under one roof, is everything you need—sets, parts, supplies, thousands of products—ready to ship to you the same day your order arrives. Barawik prices save you money. Barawik service saves you time. Barawik merchandise always pleases. A quarter million satisfied customers say, "Barawik is Best." Let us send you the Big Barawik Book free and prove it to yourself. 215E CANAL ST., BARAWIK CO. CHICAGO, U. S. A.

# New! Super Mas Tenna

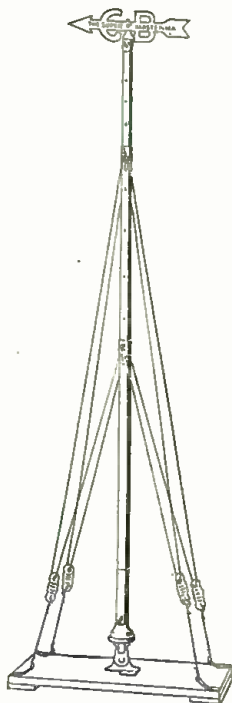

Brings Good News to  
the Radio World!

## A Vertical Aerial

that is practical, efficient, and reliable . . . . .

Gets stations, increases the selectivity and signal strength.

Approved by  
Prominent Radio Engineers

Sold by large Jobbers and Dealers  
Write for FREE BOOKLET

## Gustin-Bacon

Manufacturing Company

Dept. 1128-N Kansas City, Mo.

### MR RADIO MANUFACTURER EVERYTOWN, U. S.

### FOR THE RADIO TRADE

We maintain a complete, up-to-date mailing list of U. S. radio dealers' names which is continually revised and enlarged. These names are on stencils and ready for you to use with your next dealer mailing. Write us for further information.

EXPERIMENTER PUBLISHING COMPANY  
230 FIFTH AVENUE, NEW YORK, N. Y.

#### Quality Apparatus

Our latest bulletin No. 929 describing our complete line of quality apparatus is yours for the asking. Write for it today.

GENERAL RADIO CO.

30 State St., Cambridge, Mass.

stops and a pig-tail connection; its plates also are held rigid in position by a spacing bar. A friction brake is provided which operates on the removable shaft. The condenser has a maximum capacity of 140 mmf. (.00014-mf.) and a minimum capacity of 15 mmf., and is of excellent electrical and mechanical design.

AWARDED THE RADIO NEWS LABORATORIES CERTIFICATE OF MERIT NO. 2438.

#### MICA BALANCING CONDENSER

The small semi-variable condenser ("Type EC-70") shown, submitted by the Hammarlund Manufacturing Co., 424 W. 33rd St., New York, N. Y., is of the mica-dielectric type and designed for neutralizing or balancing radio-frequency circuits; it consists of two plates riveted to a rectangular piece of bakelite, 1 1/4 inches long, 11/16-inch wide, and 3/32 inch thick. The stationary plate is a flat piece of brass, provided with a



tongue pierced by a 1/8-inch hole for fastening to a terminal of a socket or tuning condenser, etc. The movable plate is of spring copper and separated from the stationary plate by a rectangular piece of mica which is riveted to the latter; the capacity is adjusted by a brass screw which turns into a tap in the center of the insulating support. The maximum value was found to be 15 mmf. and the minimum 6 mmf.

AWARDED THE RADIO NEWS LABORATORIES CERTIFICATE OF MERIT NO. 2439.

#### FILAMENT TRANSFORMER

The "Dependable" A.C. filament transformer shown, submitted by the Leslie F. Muter Co., 76th and Greenwood Ave., Chicago, Illinois, operates from a 110-volt, 60-cycle circuit. The transformer is of the step-down type and supplies filament current for the operation of 226-, 227-, and 112- or 171-type vacuum tubes. It has three secondary windings for 2, 3, and 5 volts, which are to be used in connection with suitable filament-regulating



resistors. The 3- and 5-volt windings are provided with a center tap, while the "nodal" point of the 2-volt winding is obtained by an external center-tapped resistor. A 6-foot cord, fitted with a standard plug, is attached to the primary winding and allows direct connection to the house-lighting circuit. The iron housing is 4 inches high, with a base 3 1/4 x 3 1/2 inches over all. The transformer is of efficient design and its operation was found to be satisfactory.

AWARDED THE RADIO NEWS LABORATORIES CERTIFICATE OF MERIT NO. 2440.

#### SOCKET ANTENNA PLUG

The "socket antenna plug" shown, submitted by the Clarostat Mfg. Co., Inc., 285 North Sixth St., Brooklyn, N. Y., converts the house-lighting circuit into an aerial for the radio receiver; it consists of a nickel-plated metal cylinder, 1 inch long and 1 1/4 inches in diameter, one end of which is fitted with two prongs for plugging into a standard receptacle, which in turn is screwed into the light socket. The other end of the device is provided



with two discs of bakelite which are clamped to the cylinder by a single rivet in their center; to which is soldered a rubber-covered cord approximately 12 feet in length, provided for connection to the receiver's aerial binding post. The measured capacity of the device was found to be .0011-mf.; the condenser is connected to only one prong,

## SAVE YOUR MONEY! BE YOUR OWN SERVICE MAN

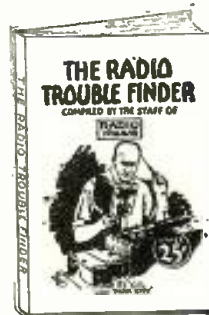

### THE RADIO TROUBLE FINDER

Even the highest-priced radio set occasionally develops a fault and that at a time when you least expect it—maybe right in the middle of an interesting program. But, a handy copy of

*The Radio Trouble Finder* is the simple means for tracing every defect and remedying it in the easiest manner possible. There is no mishap that could befall a radio, but what is fully covered in this valuable book.

*The Radio Trouble Finder* is edited by men fully versed in the subject covered—men with years of actual experience behind them—and who have grown to prominence since the infancy of radio.

Don't wait till your set goes bad—get your copy of this remarkable guide to radio trouble now. Fill in the coupon and we will send you by return mail a copy of *The Radio Trouble Finder*, a money-saving investment. You can be your own service man.

The **25c** Copy

## BUILD YOUR OWN RADIO SET

### 150 RADIO HOOK-UPS

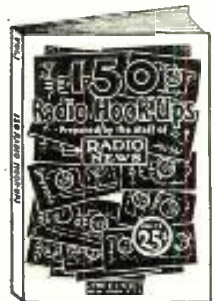

This is the latest issue of this remarkable book. Absolutely new and up-to-date. All the best circuits of the day. Full instructions on how to build. Make your own set from the diagrams shown in *150 Radio Hook-Ups*.

Write today—pick the set you want to build and make it. Then you are sure to be satisfied with the results you get.

*150 Radio Hook-Ups* was prepared by the staff of *Radio News*. An accurate guide to better set construction for the radio "fans."

The **25c** Copy

MAIL THIS COUPON NOW

CONSRAD CO., INC.  
230 FIFTH AVENUE NEW YORK, N. Y.

CONSRAD COMPANY, INC.  
230 Fifth Avenue, New York, N. Y.

Gentlemen:  
Kindly send me a copy of 150 RADIO HOOK-UPS... THE RADIO TROUBLE FINDER... (check which or both).  
Enclosed find.....cents in full payment.

Name.....  
Address.....  
City.....State.....

Please say you saw it in RADIO NEWS



If you insist on the best, they must hand you Televocals. All standard types. Ask for them at your dealers.

**Televocal Corporation**  
Televocal Building  
Dept. A-4  
588 12th Street  
West New York, N. J.

**Televocal**  
Quality Tubes

**Everything in Radio at Wholesale**  
We supply every radio need from our mammoth stock of kits, parts and sets of latest design. Lowest wholesale prices. Expert attention; immediate service. Write for big, illustrated Catalog "B-1."

**Allied Radio Corporation**  
711 W. LAKE STREET, CHICAGO

**Be an Expert RADIO OPERATOR**

Fascinating work. Wonderful opportunities. Good pay. **Teleplex Code Sender** teaches you at home in half the usual time. Reproduces actual sending of expert operators. Sends you messages, radiograms, etc.—regular code traffic anywhere, any time, any speed. U. S. Navy and leading schools endorse Teleplex as quick, easy, thorough. Complete set instruction tapes supplied at no extra cost. Write for Booklet NR.



**TELEPLEX COMPANY**  
76 Cortlandt St., New York, N. Y.

**FREE RADIO GUIDE**  
Radio has been changing so fast lately that it's hard to keep up with it. Barawik's Big Radio Guide will keep you posted on the newest wrinkles. Thousands of illustrations of sets, parts, new ideas. Big chance to save big money. Send for free copy now. **BARAWIK CO.**, CHICAGO, U. S. A.



thus being placed in series with the receiver's aerial coupler. To obtain operation in some cases, it may be necessary to reverse the position of the plug in the socket. The operation of the device is found to be satisfactory.

AWARDED THE RADIO NEWS LABORATORIES CERTIFICATE OF MERIT NO. 2441.

**SELF-ADJUSTING A.C. RHEOSTATS**

The "Amperite" (Type 226 shown), submitted by the Radiall Company, 50-52 Franklin St., New York City, has been designed for use as a ballast in series with the filament of a 226-type tube, when operated from a step-down-transformer secondary supplying approximately 2 volts. Its resistance varies with the current flowing through the circuit; at 1 ampere its resistance is 0.5-ohm and, at 1.5 amperes, 1.83 ohms. When this Amperite is used in series with a 226-type tube (whose normal operating requirements are 1.05 amperes at 1.5 volts) it requires a transformer-secondary voltage of 2 and a current value of 1 ampere.

AWARDED THE RADIO NEWS LABORATORIES CERTIFICATE OF MERIT NO. 2442.



The same manufacturer submitted also for test the Type 227 Amperite, which is designed for use in series with the filament of a 227-type tube, when it is operated from a transformer-secondary supplying 3 volts. The ballast resistance at 1.5 amperes is 0.2-ohm and, at 2 amperes, 0.43-ohm. When it is used in series with the 227-type tube, a transformer-secondary output of 1 at 3 volts is required for normal operation.

AWARDED THE RADIO NEWS LABORATORIES CERTIFICATE OF MERIT NO. 2443.

**FILTER CONDENSER**

The filter condenser (Type R171 shown) submitted by the Acme Wire Co., New Haven, Conn., has been designed for use in "B" power units of the "Thordarson R171 Compact" type, using a gas-filled rectifier. It has a continuous D.C. voltage rating of 400. Condenser sections of 8, 2, 2, 1 and 1 mf. capacity, respectively, are provided; the 8- and the 2-mf. terminals are placed upon the top, and the two terminals for the 1-mf. sections at either side. The common terminal (negative) of the latter is at the right. The five sections are placed in a metallic container, together with an



insulating compound, and hermetically sealed; the metal can is 2 inches thick, 4 1/4 inches wide, and 5 1/4 inches high. The respective sections, when measured, had capacities within 10 per cent of their rated value. When the filter was used in connection with the R171 compact, a humless "B" power supply was obtained.

AWARDED THE RADIO NEWS LABORATORIES CERTIFICATE OF MERIT NO. 2444.

**IMPROVING THE OLD SET**

Editor, RADIO NEWS:

The article in the July issue "Improving reception on a slim pocketbook" is along the right lines. Help the B.C.L. with the old sets to get better reception, and don't forget the beginner with a few hints now and then. I shunted the grid resistor on the middle dial of my Atwater Kent 20, increasing the volume materially on stations coming in below 50 on the dials; and as my model is a late one with provisions for a 171 tube and "C" battery I did not have to follow the instructions in the balance of the article.

Also, I wish to commend your items against the pure and simple fakes offered by some dealers to the radio public. This is a real service to the buying public and should be continued in an effort to remedy the condition.

E. B. CLARK,  
724 East 41st St., Baltimore, Md.

Price \$15.00



**AMAZING REGULATION OF A. C. VOLTAGES with the new WEBSTER AUTO-POTENTIALATOR**

YOU can now obtain an A. C. voltage regulator that delivers an absolutely even flow of A. C. current to your A. C. receiver or "A" and "B" eliminator. The Webster Auto-Potentialator is a new automatic device that has amazed every user with its perfect regulation. It not only delivers the proper voltage on the normally high or low line, but also effectively controls the sudden fluctuations common to all A. C. lines.

**Contains No Tubes or Liquids**

The Webster Auto-Potentialator contains no tubes or liquids. It is entirely automatic in operation. Its use will protect your A. C. tubes from burn-out, and greatly lengthen their lives.

When you hook a Webster Auto-Potentialator onto your receiver you do away with all voltage-fluctuations and can sit back and enjoy the most marvelous reception you ever listened to. It assures uniform reception, wonderful tone clarity, and tremendous volume, without any of the variations so common in unregulated A. C. sets.

**Order TODAY direct from this advertisement**

If your dealer is out of stock and you are in a hurry, you can order your Webster Auto-Potentialator direct from this ad. Just fill out the coupon below, inclose \$15.00, and mail to us, and we will ship your Auto-Potentialator the same day we receive your order. Order TODAY—end your voltage fluctuation troubles NOW.

**The WEBSTER CO.**  
858 Blackhawk Street  
CHICAGO

THE WEBSTER COMPANY  
858 Blackhawk Street, Chicago, Ill.  
Send me a Webster Auto-Potentialator as advertised in "Radio News." I enclose \$15.00.  
Name.....  
Address.....  
City..... State.....

**New Karas Short-Wave Kit Reaches Around the World!**

New radio thrills await you. Listen to Australia, Europe, Asia. Tune in on the world's airplane flyers, ships at sea; in fact, the whole world. You can do it easily with the remarkable Karas Short-Wave Receiver. You can't know the fascinations of radio until you experience this new sensation. Karas engineers have developed short wave to new peaks of perfection. Easy to build. Easy to tune with Karas Micrometric dial, 63 to 1 ratio. Uses famous Karas condensers, built like a fine watch. Karas coils and audios—the world's standard. Send now for full information and construction blueprint—Free.

**KARAS ELECTRIC COMPANY**  
4038L4 N. Rockwell St., Chicago, U. S. A.  
Name.....  
St. and No.....  
City and State.....

Insure your copy reaching you each month. Subscribe to RADIO NEWS—\$2.50 a year. Experimenter Publishing Co., 230 Fifth Ave., N. Y. C.

Please say you saw it in RADIO NEWS

# OPPORTUNITY AD-LETS

Follow these advertisements every month. Reliable advertisers from all over the country offer their most attractive specials in these columns.

Classified advertising rate twenty-two cents a word for each insertion. Ten per cent discount for 6 issues, 20 per cent discount for 12 issues. Names and addresses must be included at the above rate. Cash should accompany all classified advertisements unless placed by an accredited advertising agency. No advertisements for less than 10 words accepted.

Objectionable or misleading advertisements not accepted. Advertisements for the January issue must reach us not later than November 1st.

**CIRCULATION LARGER THAN THAT OF ANY OTHER RADIO PUBLICATION**

EXPERIMENTER PUBLISHING CO., INC., 230 Fifth Avenue, New York, N. Y.

## Agents Wanted

Guaranteed Genuine Gold Leaf Letters anyone can put on store windows. Large profits, enormous demand. Free samples. Metallic Letter Co., 422 N. Clark, Chicago.

Agents—We start you in business and help you succeed. No capital or experience needed. Spare or full time. You can earn \$50-\$100 weekly. Write Madison Products, 560 Broadway, New York.

## Books

Books, Magazines, Art Publications in French, Spanish, English. Photo novelties, samples, lists, etc., 20 cents stamps. Villaverde Co., Dept. 211, Box 1329, Havana, Cuba.

## Business Opportunities

Inventions Commercialized. Patented or Unpatented. Write Adam Fisher Mfg. Co., 278 Enright, St. Louis, Mo.

Free Book. Start little Mail Order business. Hadwil, 3A-74 Cortlandt Street, N. Y.

## Chemistry

Learn Chemistry at Home. Dr. T. O'Connor Sloane, noted educator and scientific authority, will teach you. Our home study correspondence course fits you to take a position as chemist. See our full-page ad on page 473 of this issue. Chemical Institute of New York, 16 E. 30th Street, New York City.

## Correspondence Courses

Used correspondence school courses sold on repurchase basis. Also rented and exchanged. Money-back guarantee. Catalog free. (Courses bought). Lee Mountain, Pisgan, Alabama.

## Detectives

Detectives Needed Everywhere. Travel. Experience unnecessary. Particulars Free. Write, American Detective System, 2190 Broadway, N. Y.

## Electricity

Electric Fun! Seventy stunts, 110 volts, \$1. Cooperco, Campbell, Calif.

Experimenters! Send dime for impressive 11 x 14 "Danger High Voltage" card. Cary Jones, 519 N. Taylor, Kirkwood, Mo.

## For Inventors

Inventions Commercialized. Patented or Unpatented. Write Adam Fisher Mfg. Co., 278 Enright, St. Louis, Mo.

If you have a good invention, write Hartley, Box 928, Bangor, Maine.

## Help Wanted

Government Positions. Qualify for Railway Mail Clerk, Post-Office Clerk, Carrier, Rural Carrier, and Outdoor positions. Steady Work. Mokane Institute, Dept 730, Denver, Colo.

## Help Wanted—Instructions

Wanted immediately, men to qualify for Railway Mail Clerk, P. O. Clerk-Carrier Tests, \$140-\$225 month. Write, Ozment Inst., 251, St. Louis, Mo.

## Instruction

Men—Qualify for railway postal clerk, internal revenue, mail carrier and outdoor positions; steady work; particulars free. Write Mokane Inst., Dept. B-32, Denver, Colo.

Learn Chemistry at Home. Dr. T. O'Connor Sloane, noted educator and scientific authority, will teach you. Our home study correspondence course fits you to take a position as chemist. See our full-page ad on page 473 of this issue. Chemical Institute of New York, 16 E. 30th Street, New York City.

## Male Help Wanted

Firemen, Brakemen, Baggage men (white or colored), Sleeping Car, Train Porters (colored), \$150-\$250 monthly. Experience unnecessary. 237 Railway Bureau, East St. Louis, Ill.

## Miscellaneous

Inventions Commercialized. Patented or Unpatented. Write Adam Fisher Mfg. Co., 278 Enright, St. Louis, Mo.

Farms to Cast Lead Soldiers, Indians, Marines, Trappers, Animals, 151 kinds. Send 10c for Illustrated Catalogue. H. C. Schlercke, 1034 72nd St., Brooklyn, N. Y.

## Motorcycles

Used Motorcycles. Low Terms. Also Parts. Accessories. Catalog Free. Western Motorcycle Co., 946 East 15th St., Kansas City, Mo.

## Old Money Wanted

\$2 to \$500 each paid for hundreds of Old or Odd Coins. Keep all old money, it may be very valuable. Send 10c for New Illustrated Coin Value Book 4x6. Guaranteed prices. Get posted. We pay Cash. Clarke Coin Company, 14 Street, LeRoy, N. Y.

## Patent Attorneys

Patents—Send drawing or model of your invention for examination and instructions. Advice and booklet free. Highest references. Best results. Promptness assured. Watson E. Coleman, Patent Lawyer, 724 9th Street, N.W., Washington, D. C.

Patents—Send for form "Evidence of Conception" to be signed and witnessed. Form, fee schedule, information free. Lancaster and Allvine, Registered Patent Attorneys in United States and Canada, 269 Ouray Bldg., Washington, D. C.

Patent Sense—Valuable book free. See Lacey's ad, page 507. Lacey & Lacey, 631 F. St., Washington, D. C. Established 1869.

Patents—Time counts in applying for Patents. Don't risk delay in protecting your ideas. Send sketch of model for instructions or write for free book, "How to Obtain a Patent" and "Record of Invention" form. No charge for information on how to proceed. Communications strictly confidential. Prompt, careful, efficient service. Clarence A. O'Brien, Registered Patent Attorney, 309 Security Bank Building (directly across street from Patent Office), Washington, D. C.

Patents Procured at reasonable rates with time to pay. Sales negotiated. Staff of registered attorneys and engineers. A complete service for inventors. Write for particulars. Inventors Service Bureau, Box 1648, Washington, D. C.

## Patents

Inventions Commercialized. Patented or unpatented. Write Adam Fisher Mfg. Co., 278 Enright, St. Louis, Mo.

## Printing, Engraving and Multigraving

200 Letterheads and 100 Envelopes, \$1.10, postpaid. Oberman Company, Box 1268, Chicago.

Multigraving, two dollars thousand. Miscellaneous Printing. Mayer Rey Corporation, Monmouth, Illinois.

## Printing Outfits and Supplies

Print Your Own Cards, Stationery, Circulars, Advertising, etc. Complete outfits, \$8.85; Job Presses, \$11, \$29; Rotary, \$149. Print for others; big profit. Easy rules furnished. Write for Catalog Presses, Type, Paper, etc. Kelsey Company, J-13, Meriden, Conn.

## Radio

Wanted: Men to work with National Radio Service organization. No selling scheme. Radio Doctors, Inc., Dept. N, Essex St., Salem, Mass.

A-1 five tube sets \$15.00, High Voltage B eliminator \$10.00, High Voltage ALC eliminator \$30.00. For details and other bargains write, Irvine's Radio Service, P. O. Box 67, McGregor, Texas.

## Song Poems

Song Poem Writers. "Real" proposition. Hilbeler, D7X, 2104 N. Keystone, Chicago.

## Telegraphy

Telegraphy—Both Morse and Wireless taught thoroughly. Big salaries. Wonderful opportunities. Expenses low. chance to earn part. School established fifty years. Catalog free. Dodge's Institute, Cour. St., Valparaiso, Ind.

## Wanted to Buy

Full Value Paid for Old Gold, Jewelry, Watches, Diamonds, crowns, bridges, dental gold, silver, platinum, gold or silver ore; magneto points, old false teeth. Packages returned if our offer is not satisfactory. United States Smelting Works (The Old Reliable), 39 So. State St., Dent. 16, Chicago, Ill.

**This Wholesale Catalog Will Save You Money**

Write today for our large illustrated new Catalog "B-1," showing how this organization of men with years of experience in Radio can give you personal service.

**Allied Radio CORPORATION**  
711 W. LAKE STREET, CHICAGO

**SET Builders** FREE

Selections have brought back Custom Set building. Business is booming. Thousands of old-timers are cleaning up. Let Barawik show you the way to bigger profits, more sales. Send today for Barawik's Big Bargain Book—the radio man's bible.

**BARAWIK CO.** 218B Canal St., CHICAGO, U. S. A.

Please say you saw it in RADIO NEWS



# Again Tyrman Conquers!



The pioneers of the Shielded Grid Circuit now introduce advanced features in a new series of A-C and D-C operated Custom Built Shielded Grid Receivers

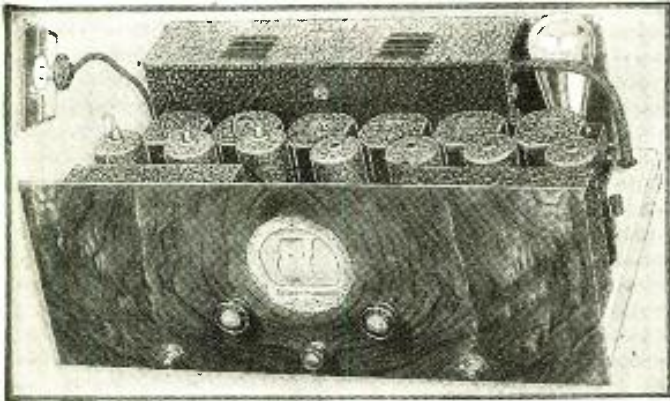

A FEW short months ago, Tyrman engineers developed and conquered the Shielded Grid Principle in radio circuits. Its introduction was heralded by Set Builders, Engineers and Editors as the greatest advance in radio since broadcasting. Today there is not a receiver using Shielded Grid Tubes which does not bear the ear marks of Tyrman influence.

Now after months of systematic experimenting, backed by unsurpassed working knowledge in Shielded Grid circuits, Tyrman Engineers again conquer principles that reach new peaks in Performance, Tonal Qualities, Beauty and Value in Custom Built Receivers.

Send for free descriptive literature. When you examine the diagrams and layouts you will quickly see why, in the Tyrman Series, you can be assured of hairline selectivity, full, rich tonal quality, unequalled power and distance under most trying conditions.

## Tyrman Imperial "80"

Custom-Built Shielded Grid  
For Complete A-C Socket Operation  
Using A-C Shielded Grid Tubes

- Short Wave Coils
- 
- UX250 Amplifying Tube
- 
- Phonograph Switch

Designed for those who want to build only the finest in A-C Socket Operated Receivers. Note the compact factory-like appearance of the chassis. Tyrman ingenuity in design places the Power Supply with other apparatus on a cadmium plated subpanel platform only 13½ in. x 20½ in. Shielded parts beautifully finished in black crystal. Power Supply designed solely for the "80" and factory assembled. No adjustments.

The actual performance of the "80" is defined by a clear 10 K. C. separation over entire broadcast wave band. Tonal quality of tremendous volume without distortion. DX reception like local without oscillation. Duo Amplification System, a new Tyrman development in the final combination with other features creates unequalled Sensitivity, Selectivity, Stability and Power.

Panel only 8 in. x 21 in. of Genuine Butt-Walnut on metal (Pat'd). New Tyrman Worm Drive Illuminated Drum. Only three controls with 110 A-C and Phonograph Switch on front panel. Simple and quick to assemble.

Receiver Parts, factory packed, \$134.80. "80" Power Supply \$65.00.  
Complete Parts for Imperial "80", short wave plug-in coils and Power Supply, ready to assemble, **\$199.50**  
only .....

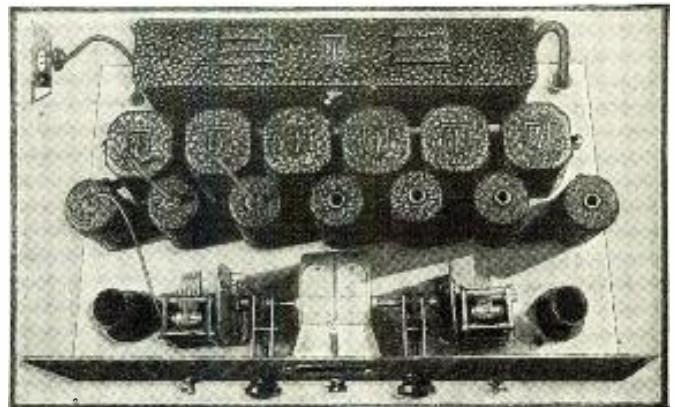

## Tyrman "72"

Custom-Built Shielded Grid

For Battery or A-C Socket Operation

The Tyrman "72" can be assembled for battery, eliminator or Complete A-C Socket operation. Even if assembled as a battery set it is a simple matter to convert to complete socket operation. When assembled for A-C Socket Operation uses A-C Power Supply especially designed for the "72" mounted on subpanel platform. The Tyrman Duo System of Amplification, and Tyrman Audio Coupler System assure rich tonal qualities.

Sensitivity, Stability, Selectivity, Power and Distance comparable only to the Imperial "80". Front Panel only 8 in x 21 in. of beautiful burl-walnut finish on metal. Tyrman Illuminated Worm Drive Double Drum, 110 A-C Switch and Phonograph pick-up Jack on panel. Easily and quickly assembled. Complete parts for either battery or A-C operation, factory packed, ready to assemble, **\$98.50**

The "72" Power Supply for A-C Socket operation, factory assembled, **\$55.00**. Complete set plug-in coils \$10.

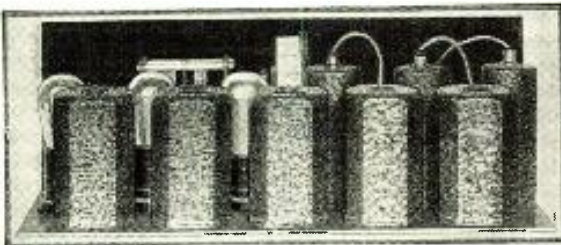

## Tyrman "60"

Custom-Built Shielded Grid

For Battery or Eliminator Operation

For appearance, tone quality, distance, selectivity, sensitivity, stability and power, the Tyrman "60" is comparable only to other Tyrman Shielded Grid Receivers. An improved design for battery or eliminator operation. Especially designed for Shielded Grid Tubes. Every part made of finest materials, carefully tested and matched. The Tyrman "60" creates a new standard of comparison for performance and value in six tube receivers. Panel only 7 in. x 18 in. equipped with Tyrman Single Vernier Drum Dial. Complete parts, factory packed, **\$69.50**  
ready to assemble, only .....

**Tyrman Electric Corporation**  
Dept. 218, 314 WEST SUPERIOR STREET  
CHICAGO, ILLINOIS

Send for FREE literature describing this remarkable New Series of Receivers

Tyrman Electric Corporation Dept. 218, 314 W. Superior St. Chicago, Illinois. Without obligation send me free literature describing Tyrman Custom Built Receivers.

I am particularly interested in \_\_\_\_\_ "80" A-C Operation \_\_\_\_\_ "72" A-C or Battery operation \_\_\_\_\_ "60" Battery Operation.

NAME \_\_\_\_\_

ADDRESS \_\_\_\_\_

MY JOBBER \_\_\_\_\_

Please say you saw it in RADIO NEWS



## Lowest Wholesale Prices

### Set Builders

Set Builders and experimenters will welcome an association here where tremendous stocks of practically all of the nationally advertised lines are carried—coupled with an organization trained to serve. Immediate shipments are assured. Silver-Marshall—Hammarlund—Roberts—Aero—Tyrman and practically all of the latest kits and parts are available. Your orders, large or small, will be handled with a promptness and dispatch that should prove a revelation to you in Radio Service.

### Dealers

Dealers who line up with Allied Service will never disappoint their trade on deliveries. Our immense stocks in Sets, Parts, Kits and Accessories enable you to render real service to your trade. Immediate shipments insure rapid turnover—eliminating the necessity of carrying large stocks on hand—and this, along with lowest market prices, will prove an ideal connection for the live dealer.

Allied Radio Corporation is composed of a large corps of trained men who have had years and years of experience in radio. They know how to get results. Their great fund of experience is now available for your benefit. They know the newest improvements, the up-to-the-minute demands of the trade, and are ready to give you personal, helpful service.

### 50,000 Feet of Radio

50,000 square feet of floor space in a large modern building is devoted exclusively to radio. Floor after floor is filled with a tremendous stock of every variety that is exceptionally complete in kits, parts and sets of every description. Here are found the latest improved designs and styles in radio equipment.

### New A.C. Sets and Kits

New A.C. sets priced as low as \$35.45. Also a wonderful array of beautiful consoles ranging in price from as low as \$12 up to \$200. A complete assortment of the famous Silver-Marshall parts and kits—in stock ready for your call. Practically all of the nationally advertised lines in parts and kits are available here for immediate shipment. New A.C. Sets, Power Dynamic Speakers—all the

latest and newest in Radio is here at prices that actually defy competition.

### Lowest Wholesale Prices

Tremendous sales volume coupled with a rapid turnover to the thousands of radio dealers throughout the country who have come to depend on Allied Service enables us to go into the open market and buy for cash—at tremendous savings—and these savings are passed right on to you in the way of better merchandise and lower prices.

### Immediate Shipments

The Allied organization is trained to service. Real team work from executives and department managers to stock clerks and office boys—all animated by a desire to serve—to make Allied service Radio's most dependable service.

Send for Large, Free, New, Illustrated Catalog "B-1"

# Allied Radio CORPORATION

Wholesale Radio Distributors

711 West Lake Street Dept. B-1 Chicago, Illinois

Please say you saw it in RADIO NEWS

At last we have caught up with the demand  
 PROMPT DELIVERIES NOW ASSURED ON

the NEW  
 Amazing

# SCOTT SHIELD GRID 9

WORLD'S  
 RECORD



Here unquestionably is the most powerful receiver we have yet produced. I extend a most cordial invitation to all set builders to visit us at our large new laboratory to see and hear our laboratory models and to observe firsthand the precision and care taken in matching and testing all parts of this remarkable set.  
 E. H. Scott

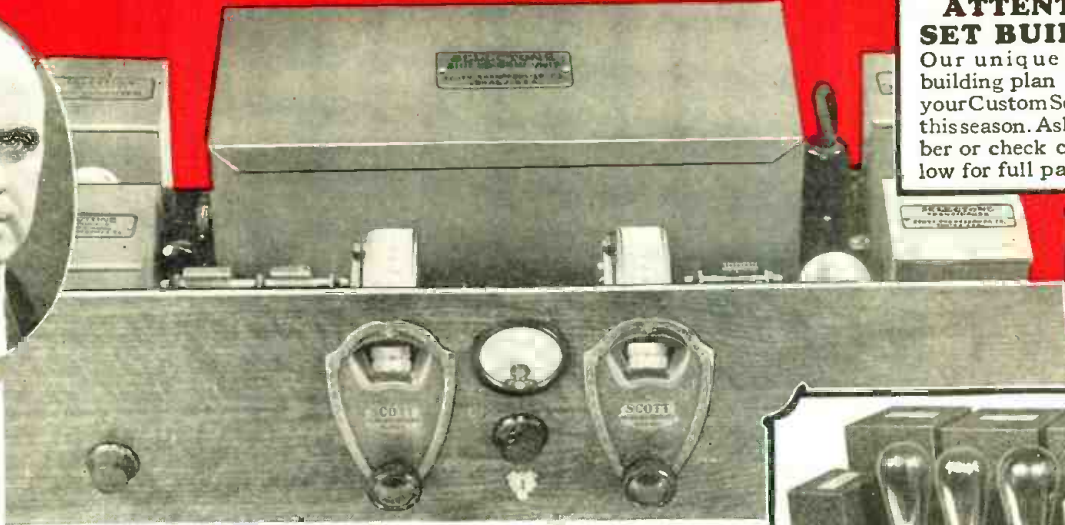

**ATTENTION! SET BUILDERS**  
 Our unique business building plan will triple your Custom Set business this season. Ask your jobber or check coupon below for full particulars.

**Shield Grid Amplifier gives tremendous gain**



**SCOTT POWER PACK AND AMPLIFIER**  
 This fully shielded unit is especially designed to supply current for the Shield Grid Nine, and also has incorporated in it the second stage of audio, using a 250 power tube.

## Challenges the whole radio world to any test of Distance-Volume-Selectivity-Tone!

The Scott Shield Grid Nine and Power Amplifier is a standing challenge to the entire world of radio to match its superb performance. In range it is practically *unlimited*—due to the tremendous amplification of the *Shield Grid* long range amplifier employed. In volume, selectivity, and tonal purity, it is absolutely unrivaled. It is the successor to a line of famous World's Record Receivers—and is to our knowledge the most powerful set available today.

### Shield Grid Tubes In Improved New Circuit

Perhaps the greatest single factor in increasing the efficiency of this new Scott receiver is the use of the new Shield Grid Tubes, in a new, improved circuit. This gives many times the amplification obtainable from an ordinary circuit using 201A tubes, making this receiver more powerful than any other existing receiver known to us.

### Perfect Matching of Parts Gives Enormous Gain

To further increase efficiency in the new Scott receiver, not only are the tubes shielded, but the transformers as well. The extreme care taken in matching and testing the transformers is another reason for the amazing volume obtained from far distant stations. All parts throughout are especially designed and painstakingly matched with precision equipment. The special Selectone Two-Gang condenser, for instance, matches the inductances of the antenna and R. F. coils so perfectly that they line up throughout the scale and afford astonishing

selectivity with maximum amplification from the lowest to the highest wave lengths.

### One Spot Reception

The Scott Shield Grid Nine is a one spot Super Stations come in at one point only on the dial, both of which track practically together, making tuning extremely easy. The Scott Power Amplifier, used with receiver, makes it possible to receive immense volume without the slightest distortion. This volume is so completely under control that the turning of one knob covers the entire range from merest whisper to full audio volume—always with life-like clarity and beauty.

### Low Operating Cost

The Scott Shield Grid Nine can be economically operated with dry batteries if desired. The eight tubes incorporated in the receiver draw only 29 mls. and will give ample volume for the average home. Where A. C. current is available, the special new Scott Power Pack and Amplifier, with the ninth tube for the second stage of audio, it uses. This is the latest 250 power tube, affording enormous volume with matchless tone quality.

### EASY TO BUILD—Results Guaranteed

Although the Scott Shield Grid Nine is one of the most highly perfected sets ever designed, it is an amazingly simple one to build. Anyone can assemble it in four hours. Both panel and sub-panel are drilled to receive each part, and the shielded grid amplifier unit comes to you fully wired and tested—ready to be connected into the circuit as simply as hooking-up a transformer. No adjustments are required of the builder and you can't go wrong on the assembly. We positively guarantee that you

will get the same results we obtain from our laboratory models.

For the small cost of the Scott Shield Grid Nine you can get all that could be desired of radio—the very newest, finest developments of the day. Why not enjoy World's Record performance when you can have it at less cost than inferior reception? Why not have a receiver that provides actual 10 kilocycle selectivity? Why not listen in on a radio that gives you the whole world. Build the Scott Shield Grid Nine and have it. Enjoy the ultimate in radio—NOW! Act Today!

## FREE Circuit Diagram and Particulars

Write at once for full particulars. Let us send you FREE the Scott Circuit Diagram. Examine it yourself. See with your own eyes why it affords unequalled performance—limitless range—tremendous power—matchless tone. Proof will be sent you FREE. Also copies of 6,000 and 9,000 mile reception verifications and other astonishing records. Clip coupon and mail today. Do this NOW!

----- CLIP THIS NOW AND MAIL -----

SCOTT TRANSFORMER CO.  
 4454 Ravenswood Ave., Chicago, Ill.  
 Please send me FREE circuit diagram, records, and full particulars of the new Scott Shield Grid Nine.

Check here for proposition to professional set builders.

Name .....

Street .....

Town ..... State .....

SCOTT TRANSFORMER CO., 4454 Ravenswood Ave., Chicago, Ill.

Compare With Costliest Sets!

**ENJOY ANY MIRACO 30 DAYS = RETURN EVERYTHING, OUR EXPENSE, UNLESS DELIGHTED**

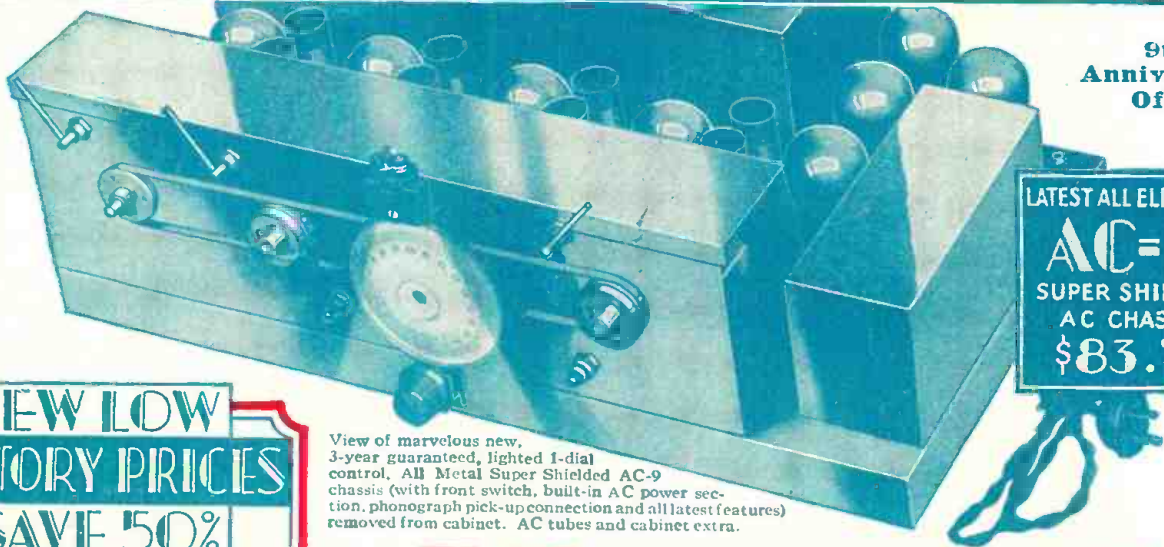

9th Anniversary Offer

LATEST ALL ELECTRIC  
**AC-9**  
SUPER SHIELDED  
AC CHASSIS  
**\$83.75**

View of marvelous new, 3-year guaranteed, lighted 1-dial control, All Metal Super Shielded AC-9 chassis (with front switch, built-in AC power section, phonograph pick-up connection and all latest features) removed from cabinet. AC tubes and cabinet extra.

**NEW LOW FACTORY PRICES SAVE 50%**

Wide Selection of Beautiful Cabinets AC or Battery Sets  
**30 DAYS HOME TRIAL**

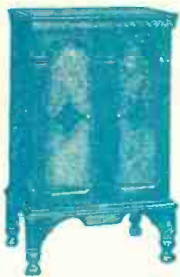

A popular walnut Hi-Boy Console, with drop-leaf desk. Beautiful two-tone finish. Rare bargain!



Beautifully graceful Spinet console, genuine two-tone walnut. Choice of speakers. Also comes in Electric Phonograph-Radio Combination.



A new-type arm-chair console. Genuine walnut. Very pretty. Low priced. Electro-Dynamic or Magnetic-Power Speakers.



At right, a Lo-Boy console, walnut finish, that costs little. A gem!



Above, popular inexpensive combination. Set on Table Speaker (sold separately).



Metal or wood compact style cabinets. Wood cabinets in walnut or new shaded silver-chrome finishes. Cathedral Electro-Dynamic or Magnetic-Power Speaker to match!

# MIRACO

TRADE MARK REGISTERED

CATHEDRAL TONED, SUPER SELECTIVE, POWERFUL DISTANCE GETTERS

Celebrating its 9th successful year, America's big, old, reliable Radio Corporation springs a genuine sensation in high-grade sets. With its latest, Super-powered, 1-dial Miracos—the All Electric wholly self-contained, hum-free, AC-8 and AC-9, using AC tubes or the new 8-tube models for batteries or Eliminators—you are guaranteed values and savings unsurpassed in the fine set field.

Compare a Miraco with highest-priced radios, for 30 days in your home. Surprise and entertain your friends—get their opinions. Unless 100% delighted, don't buy it! Return everything—the complete outfit—at our expense. Your decision is final—absolutely!

Only exceptionally fine radios, of the very latest approved type, at rock-bottom prices, could possibly back up so liberally unconditional a guarantee. Send coupon now for *Amazing Special Factory Offer!*

**Don't Confuse with Cheap Radios** With its rich, clear Cathedral tone,

hum-free operation, tremendous "kick" on distant stations and razor-edge selectivity—with its costly sturdy construction, latest features, including phonograph

pick-up connection, ease of tuning, beauty, and economy—a Miraco will make you the envy of many whose radios

cost 2 to 3 times as much! Many thousands of Miracos—bought after 30 day home comparisons—are cutting through locals and getting coast to coast with the tone and power of costly sets, their delighted users report. Miracos are laboratory-built with finest parts, and embody 9 years' actual experience in constructing fine sets. Approved by Radio's highest authorities.

**Deal Direct with Big Factory**

Everything reaches you splendidly packed and rigidly tested to insure your instant enthusiasm. Enjoy the outfit 30 days—then decide. Liberal 3-year guarantee on each set. Play safe, save lots of money, and insure satisfaction by dealing direct with Radio's old, reliable builders of fine sets—9th successful year.

**IMPORTANT NOTICE!**

"30 Day Free Trial" offers usually are money-back guarantees frequently only on the "set." Please understand that unless you are thoroughly pleased we pay return charges and refund the FULL purchase price on both the "set" and ALL equipment—tubes, cabinet, speaker, antenna (also on batteries or eliminators with ultra-8 sets). Could any offer be fairer?

**MIDWEST RADIO CORP'N, 404-AN Miraco Bldg., Cincinnati, Ohio**

Dealers Write!



**Free!**

**MIDWEST RADIO CORPORATION**  
Pioneer Builders of Sets—9th Successful Year  
404-AN Miraco Bldg., Cincinnati, Ohio



**AC-8—\$71.50**

Unbeatable value in a 3-year guaranteed Super Shielded Metal Chassis (similar to AC-9 shown above).



**Also New, More Powerful Battery Sets**

The newest and latest in battery operated sets, designed with same advanced features used in electric sets! Same wide choice of cabinets. Highest quality, amazingly low priced!

**8-tube Battery**

**Super Shielded Metal Chassis \$49.88**

Tubes, batteries or eliminators and cabinets are extra. 30 days home trial on EVERYTHING!

**THIS COUPON IS NOT AN ORDER**

WITHOUT OBLIGATION, send free catalog, Amazing Special Factory Offer, testimony of nearby users, etc.  User  Agent  Dealer  
 Check here if interested in an EXCLUSIVE TERRITORY PROPOSITION  
NAME ADDRESS